



US00D531087S

(12) **United States Design Patent**
Newton

(10) **Patent No.:** **US D531,087 S**
(45) **Date of Patent:** **** Oct. 31, 2006**

(54) **VEHICLE**

- (75) Inventor: **Raymond J. Newton**, Huntington Beach, CA (US)
- (73) Assignee: **Pteazer, Inc.**, Huntington Beach, CA (US)
- (**) Term: **14 Years**

(21) Appl. No.: **29/216,139**
 (22) Filed: **Oct. 29, 2004**

- (51) **LOC (8) Cl.** **12-08**
- (52) **U.S. Cl.** **D12/91**
- (58) **Field of Classification Search** D12/90-92,
D12/86; D21/424, 433; 296/181.1
See application file for complete search history.

(56) **References Cited**

U.S. PATENT DOCUMENTS

D394,420 S	5/1998	Forbes-Robinson
D406,551 S	3/1999	Nesbitt et al.
D412,299 S	7/1999	Shikado
D413,081 S	8/1999	Nesbitt et al.
D416,524 S	11/1999	Gaboth
D425,846 S	5/2000	Kawaoka
D426,799 S	6/2000	Fink
D427,553 S	7/2000	Pfeiffer
D427,955 S	7/2000	Sacco et al.
D430,065 S	8/2000	Carlson et al.
D430,821 S	9/2000	Carlson et al.
D439,203 S	3/2001	Ragone
D440,191 S	4/2001	Pfeiffer
D443,575 S	6/2001	Okazaki et al.
D447,457 S	9/2001	An
D447,725 S	9/2001	Hatter
D447,726 S	9/2001	Okano
D450,284 S	11/2001	Caroselli
D452,469 S	12/2001	Sacco et al.
D452,668 S	1/2002	Yokomaku
D452,669 S	1/2002	Yokomaku
D452,670 S	1/2002	Ishii et al.

(Continued)

OTHER PUBLICATIONS

Brochure—*Chrysler 2001 PT Cruiser Accessories from Mopar*, © 2000 DaimlerChrysler Corporation.
 CarDomain Website pages on the 2001 Chrysler PT Cruiser referred to as Eddie's Chrysler coolZero (<http://www.car-domain.com/memberpage/69725>).
 CarDomain Website pages on the 2001 Chrysler PT Cruiser referred to as Eddie's Chrysler coolZero (<http://www.car-domain.com/memberpage/69725/4>).
 Zuko Website pages on Chrysler PT Cruiser Show Cars (http://www.zuko.com/Cool_Rides/PT_Cruiser_Show.htm).

Primary Examiner—Melody N. Brown
 (74) *Attorney, Agent, or Firm*—Orrick, Herrington & Sutcliffe LLP

(57) **CLAIM**

The ornamental design for a vehicle, as shown and described.

DESCRIPTION

FIGS. 1 through 6 illustrate a convertible vehicle according to the present invention, wherein
 FIG. 1 is a perspective view of a vehicle showing my new design;
 FIG. 2 is a front view,
 FIG. 3 is a top view,
 FIG. 4 is a side view (the opposite side being the same),
 FIG. 5 is a rear perspective view, and
 FIG. 6 is a rear view;
 FIGS. 7-9 illustrate a modified version of the vehicle with a sport top wherein
 FIG. 7 is a perspective view showing a second embodiment of my new design;
 FIG. 8 is a side view of FIG. 7; and,
 FIG. 9 is a rear view of FIG. 7.
 In each of the embodiments, the wheel details, interior details and license plate do not form a part of the design of the vehicle.

1 Claim, 5 Drawing Sheets

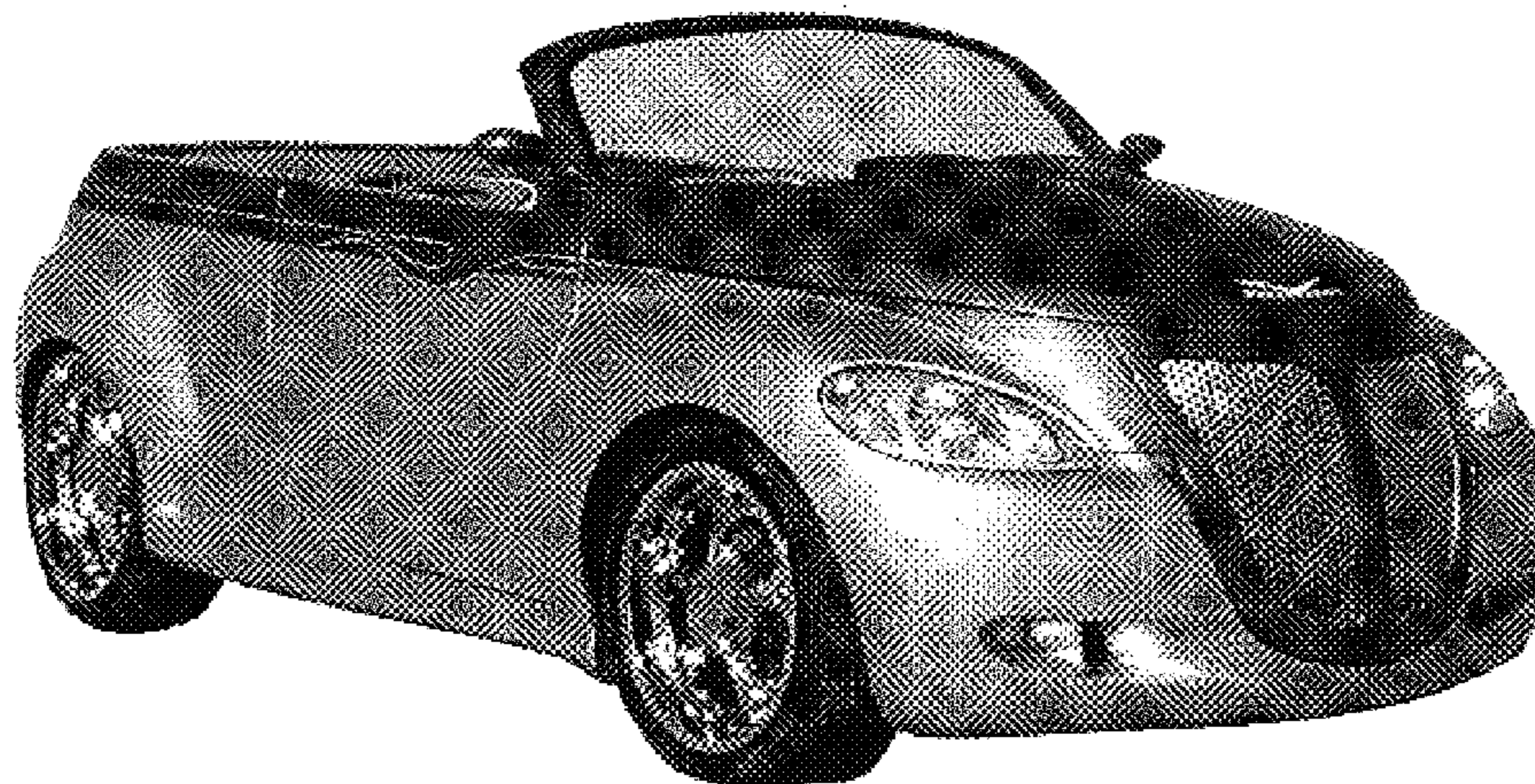

US D531,087 S

Page 2

U.S. PATENT DOCUMENTS

D455,983 S	*	4/2002	Carlson	D12/92	D460,935 S	7/2002	Newton
D459,278 S		6/2002	Newton			D469,390 S	1/2003	Newton
D460,725 S		7/2002	Newton			D471,493 S	3/2003	Newton
D460,933 S		7/2002	Newton			D497,852 S	11/2004	Newton

* cited by examiner

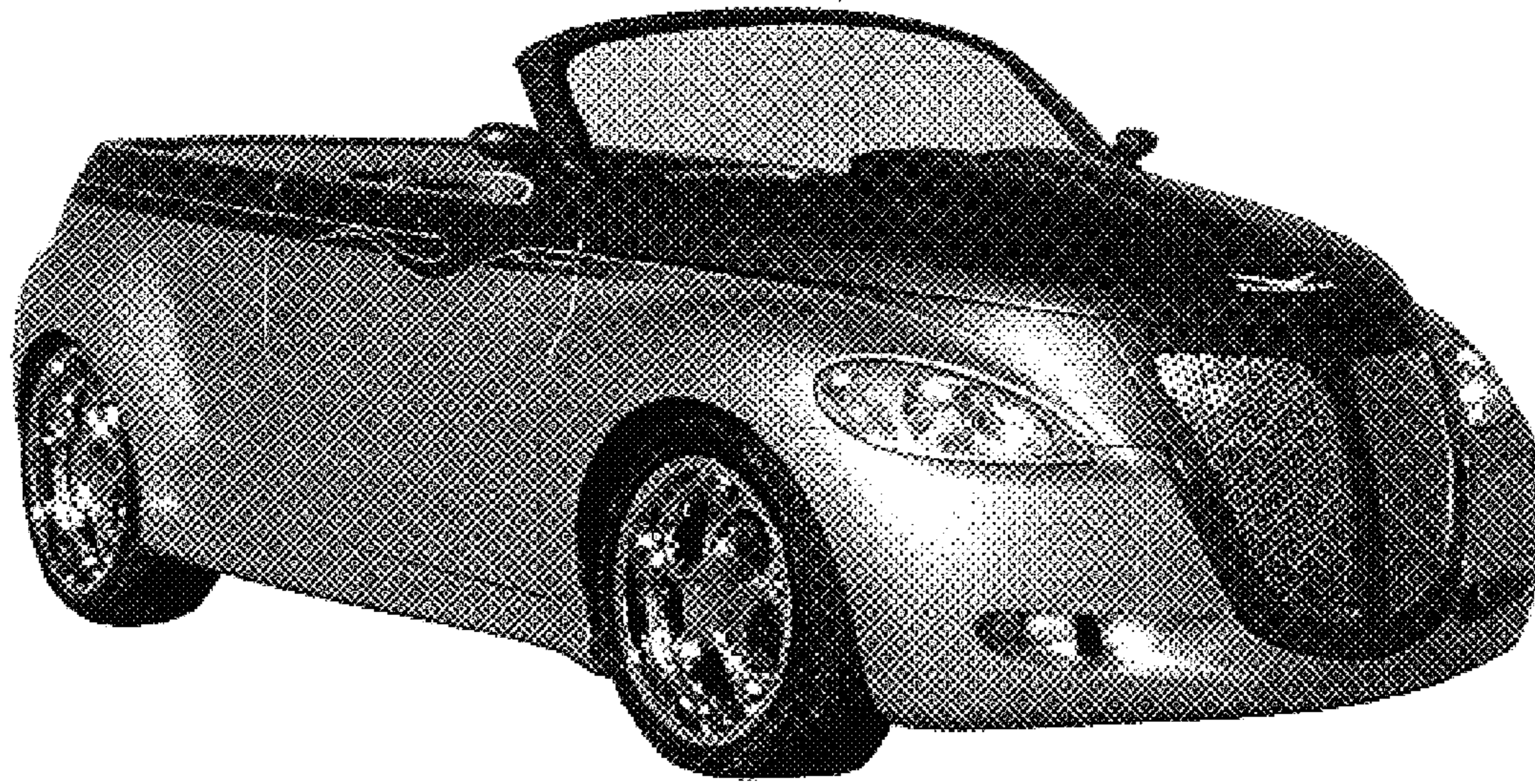

FIG. 1

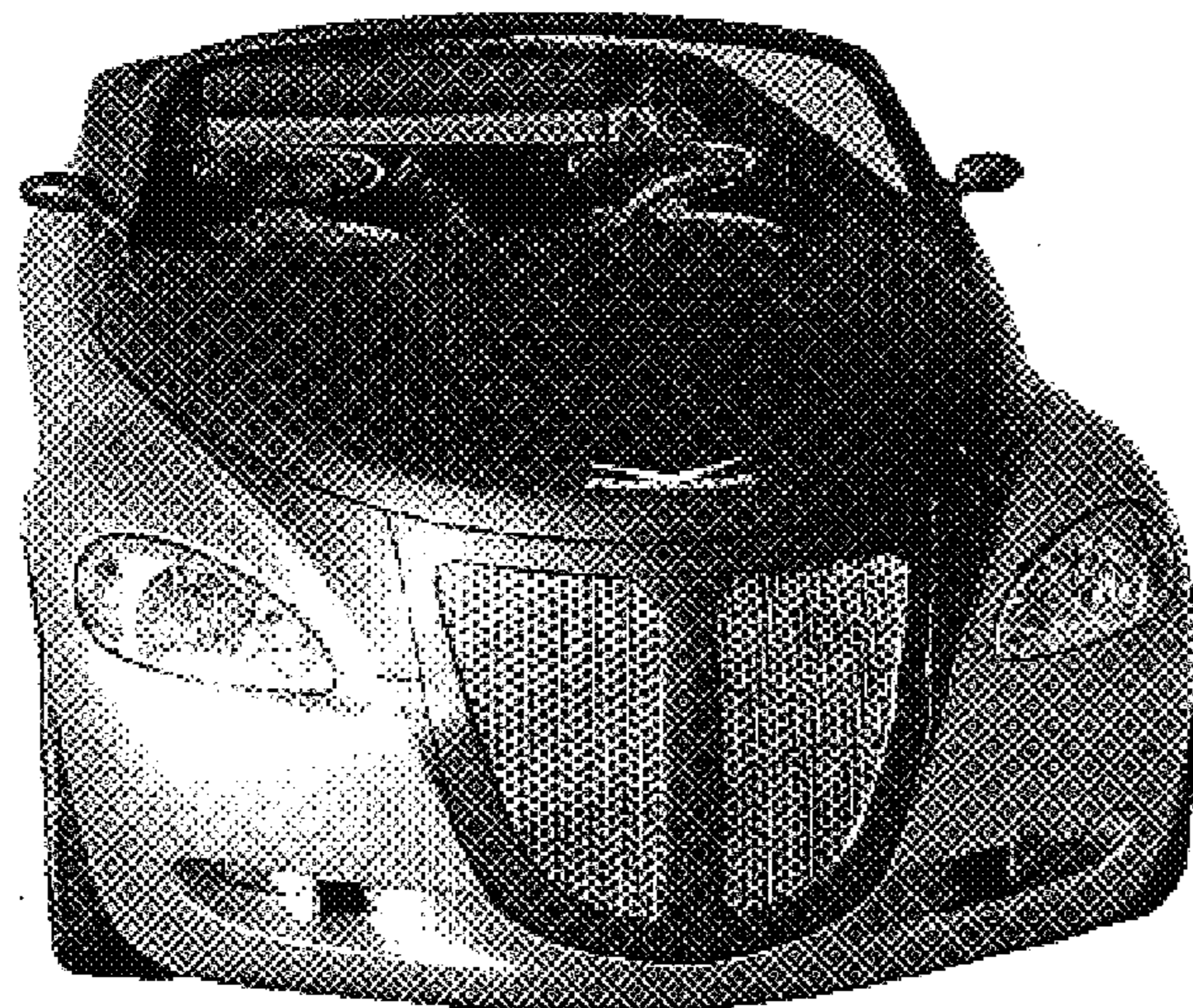

FIG. 2

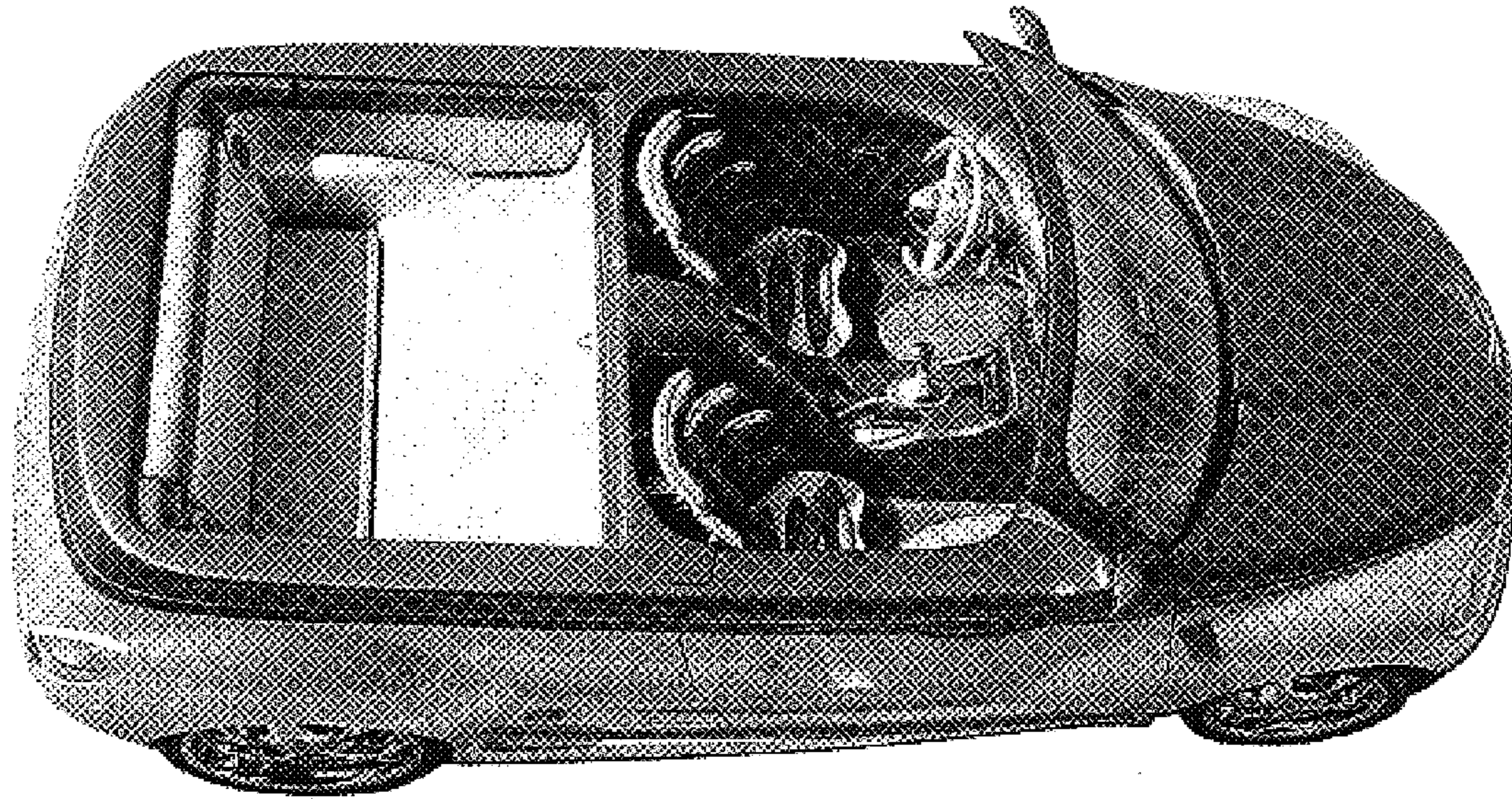

FIG. 3

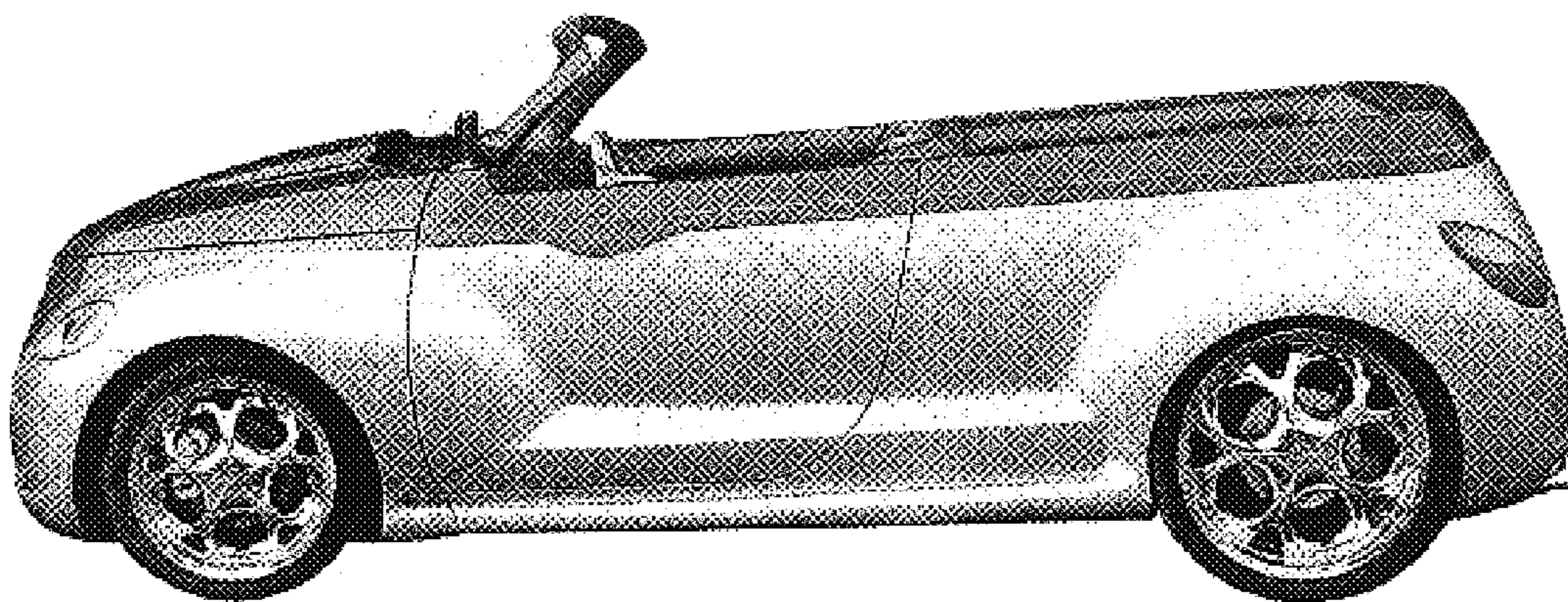

FIG. 4

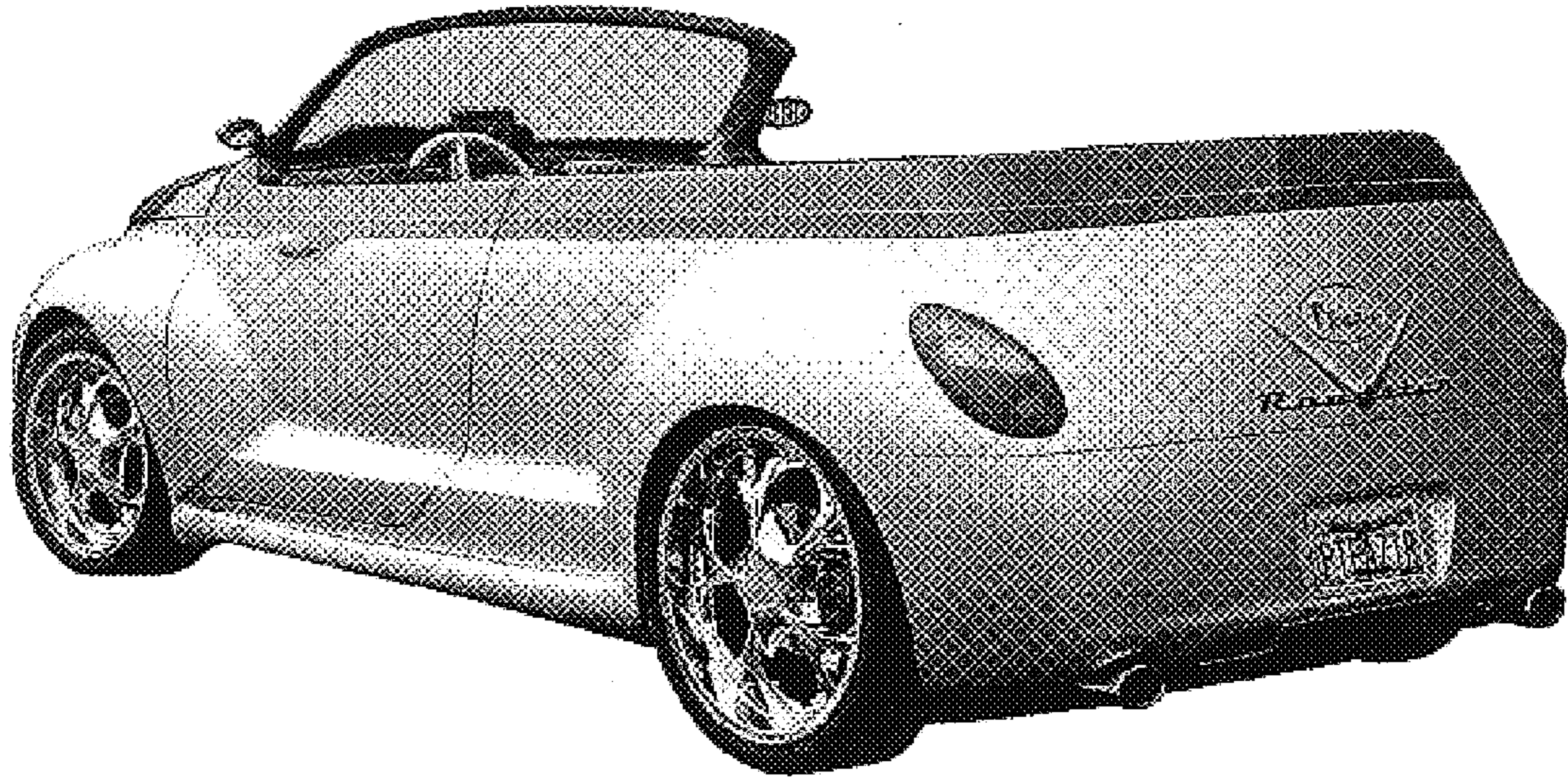

FIG. 5

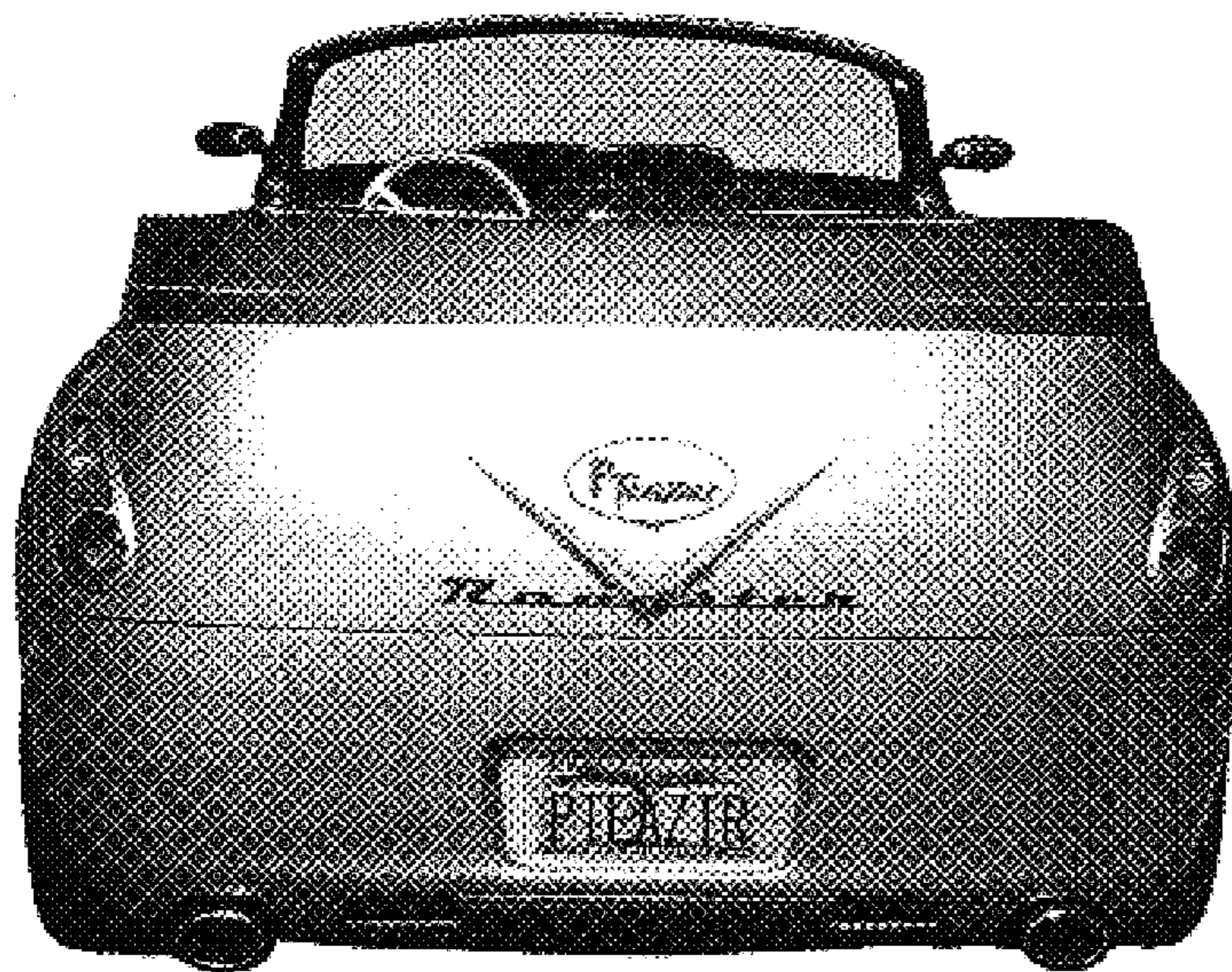

FIG. 6

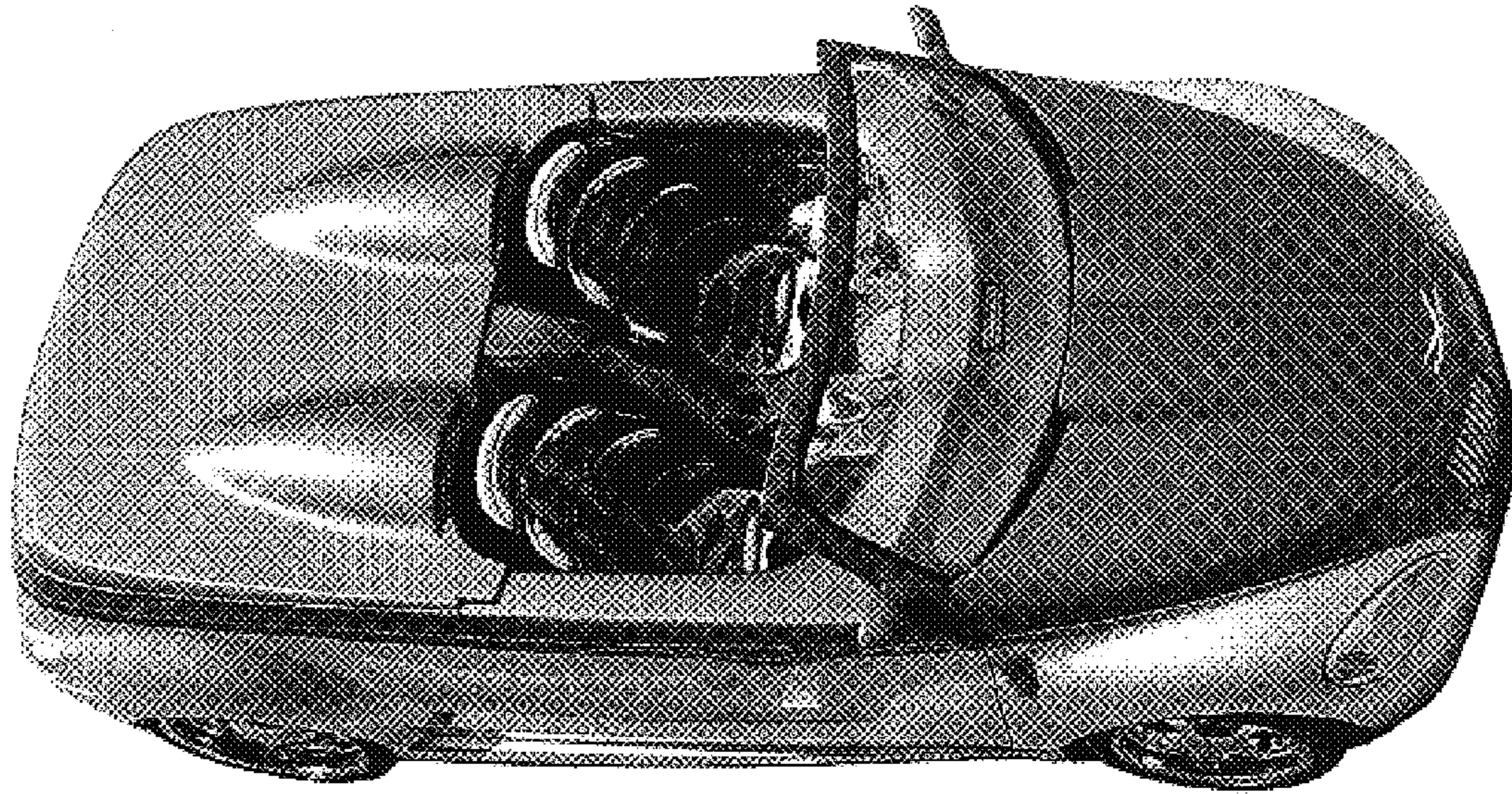

FIG. 7

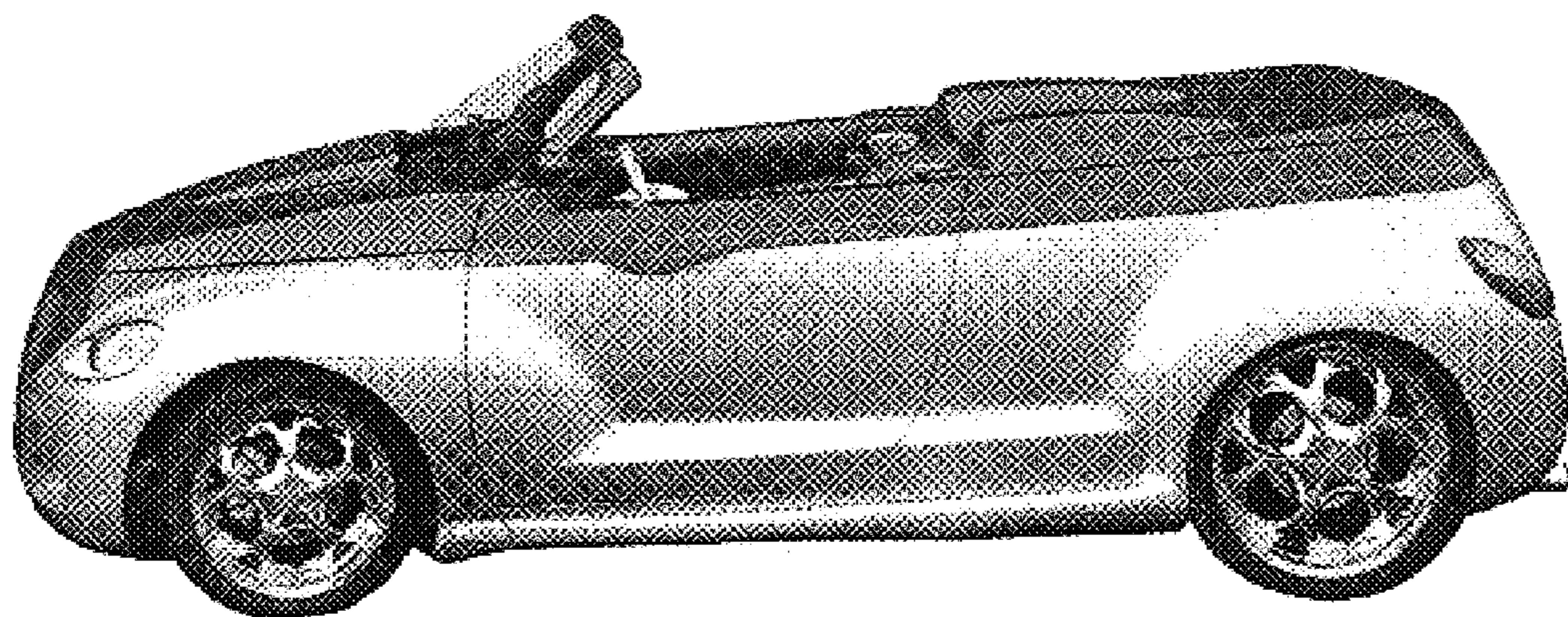

FIG. 8



FIG. 9