



US00D531079S

(12) **United States Design Patent**  
**Scharr**

(10) **Patent No.:** **US D531,079 S**  
(45) **Date of Patent:** **\*\* Oct. 31, 2006**

(54) **COMBINED JEWELRY COMPONENT AND A CAP**

(76) Inventor: **Paul R. Scharr**, 6574 E. Crested  
Saguaro La., Scottsdale, AZ (US)  
85262-7373

(\*\*) Term: **14 Years**

(21) Appl. No.: **29/255,393**

(22) Filed: **Mar. 8, 2006**

(51) **LOC (8) Cl.** ..... **11-01**

(52) **U.S. Cl.** ..... **D11/86**

(58) **Field of Classification Search** ..... D11/1-2,  
D11/740-44, 46-49, 53, 56-57, 59-61, 63,  
D11/65, 79-83, 86-87, 89-90, 99, 91-92,  
D11/101, 106, 114-116, 200-201; 63/1.11,  
63/18-20; D3/207-211

See application file for complete search history.

(56) **References Cited**

**U.S. PATENT DOCUMENTS**

1,380,827	A	*	6/1921	Mullins	.....	63/3.1
3,168,768	A	*	2/1965	Bohlinger et al.	.....	24/116 A
D391,844	S		3/1998	Ropponen		
D392,179	S		3/1998	Ropponen		
D415,676	S		10/1999	Negishi		
D416,475	S		11/1999	DePrisco		
D419,431	S		1/2000	Hollis		
D422,202	S		4/2000	Maki		
D469,007	S		1/2003	Chen		
D477,224	S		7/2003	Hussain		
D480,951	S		10/2003	Robinson		
D493,097	S		7/2004	Shinjo		
D501,396	S		2/2005	Frattarola		
D506,922	S		7/2005	Simon		

\* cited by examiner

*Primary Examiner*—Ralf Seifert

(57) **CLAIM**

I claim the ornamental design for a combined jewelry component and a cap, as shown and described.

**DESCRIPTION**

Cross reference to other related design Patent Applications: Another design patent application 29/255,392 also filed on Mar. 6, 2006 entitled: "Screw for Jewelry Components".

FIG. 1 is an exploded perspective view of the combined jewelry component and a cap, with the cap removed; according to the present invention;

FIG. 2 is an exploded perspective view having a combined jewelry component and a cap, with the cap attached; according to the present invention;

FIG. 3 is the front view of the combined jewelry component and a cap, with the cap removed, the rear view is identical to the front view;

FIG. 4 is the right side view of the combined jewelry component and a cap, with the cap removed, the left view is identical to the right view.

FIG. 5 is the bottom view of the jewelry component and the bottom view of the cap, with the cap is removed from the jewelry component;

FIG. 6 is the top view of the jewelry component and the top view of the cap, with the cap removed from the jewelry component;

FIG. 7 is the front view of the combined jewelry component and a cap, with the cap attached, the rear view is identical to the front view;

FIG. 8 is the right side view of the combined jewelry component and a cap, with the cap attached; the left view is identical to the right view;

FIG. 9 is the bottom view of the combined jewelry component and a cap, with the cap attached; and,

FIG. 10 is the top view of the combined jewelry component and a cap, with the cap attached.

**1 Claim, 3 Drawing Sheets**

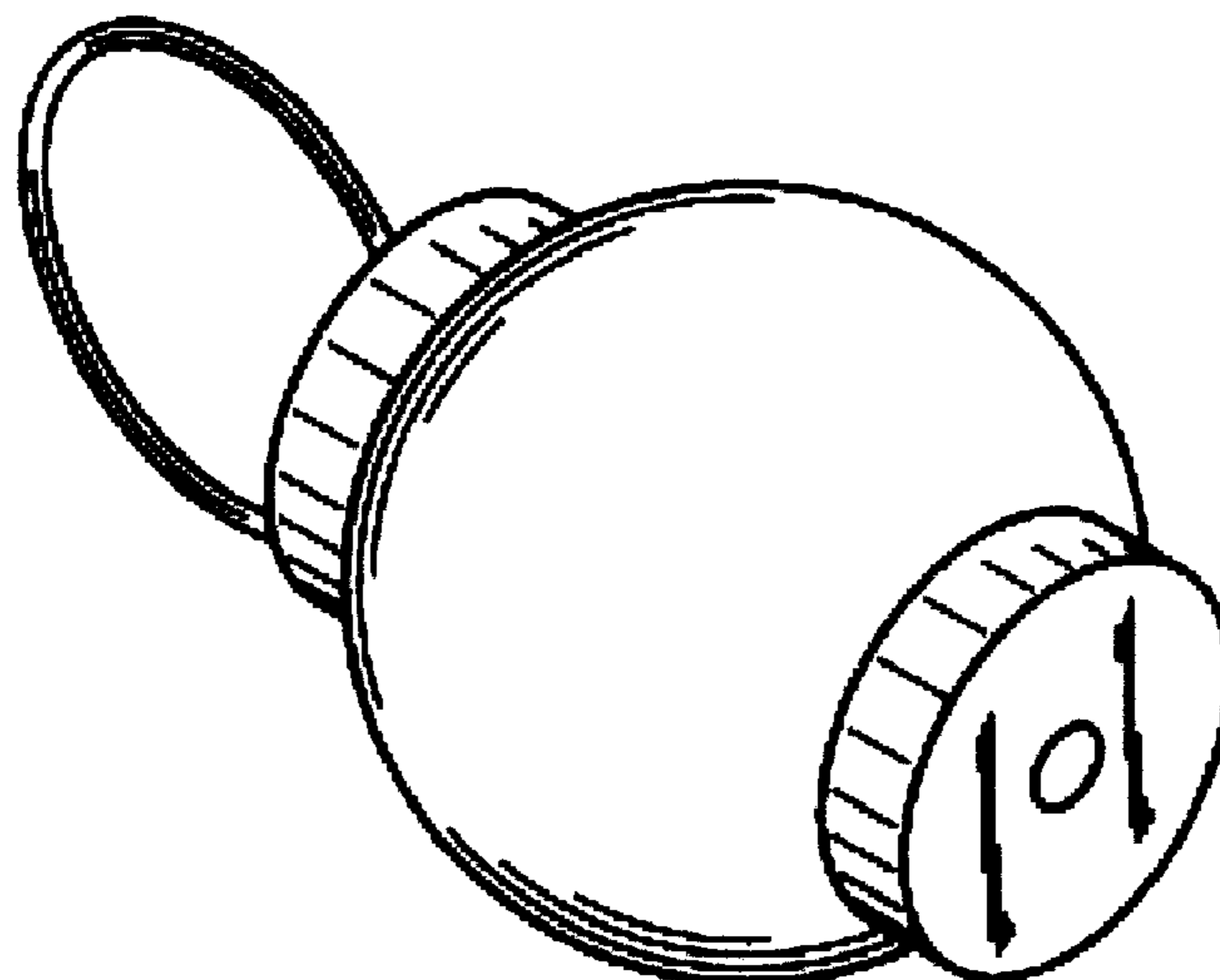

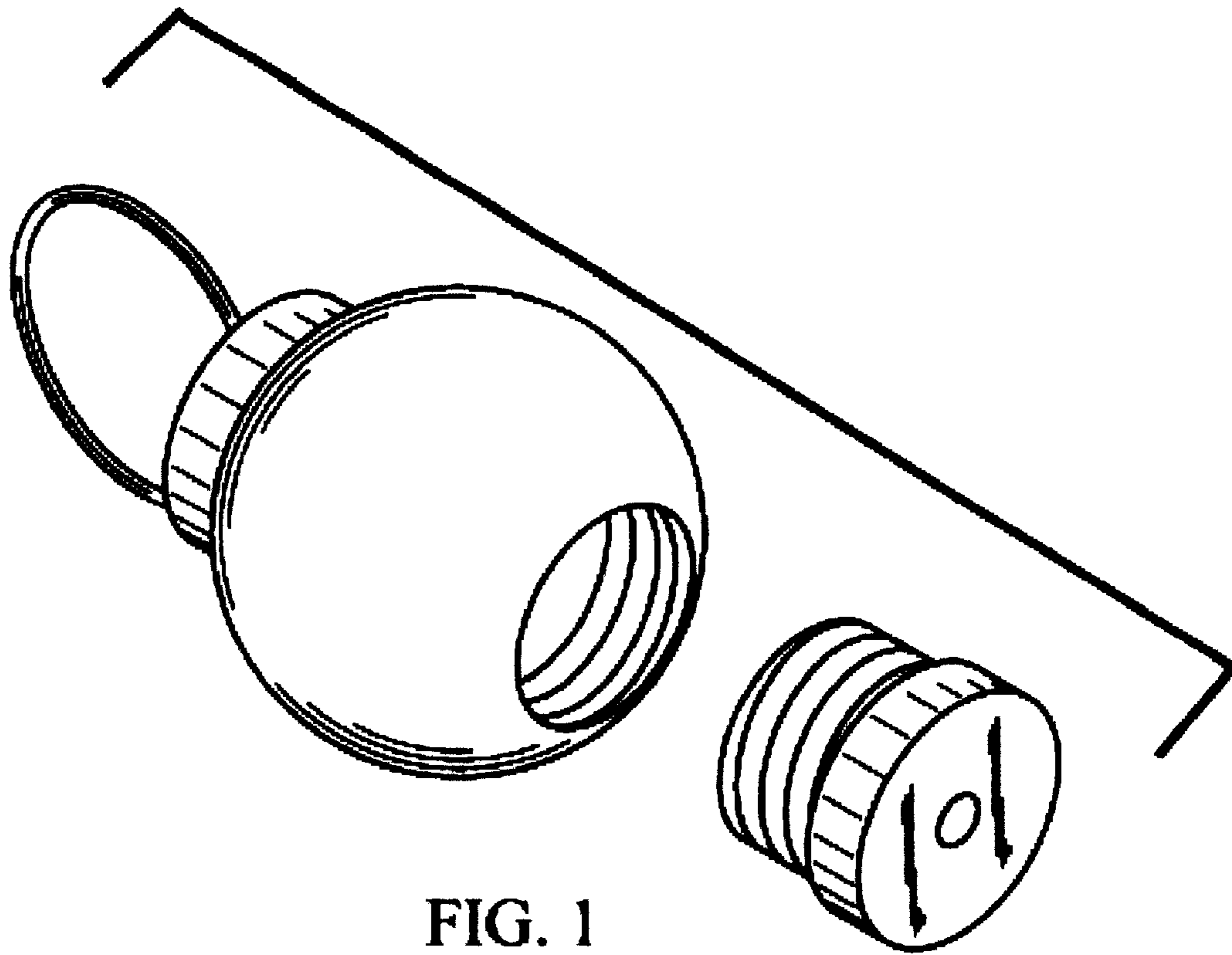

FIG. 1

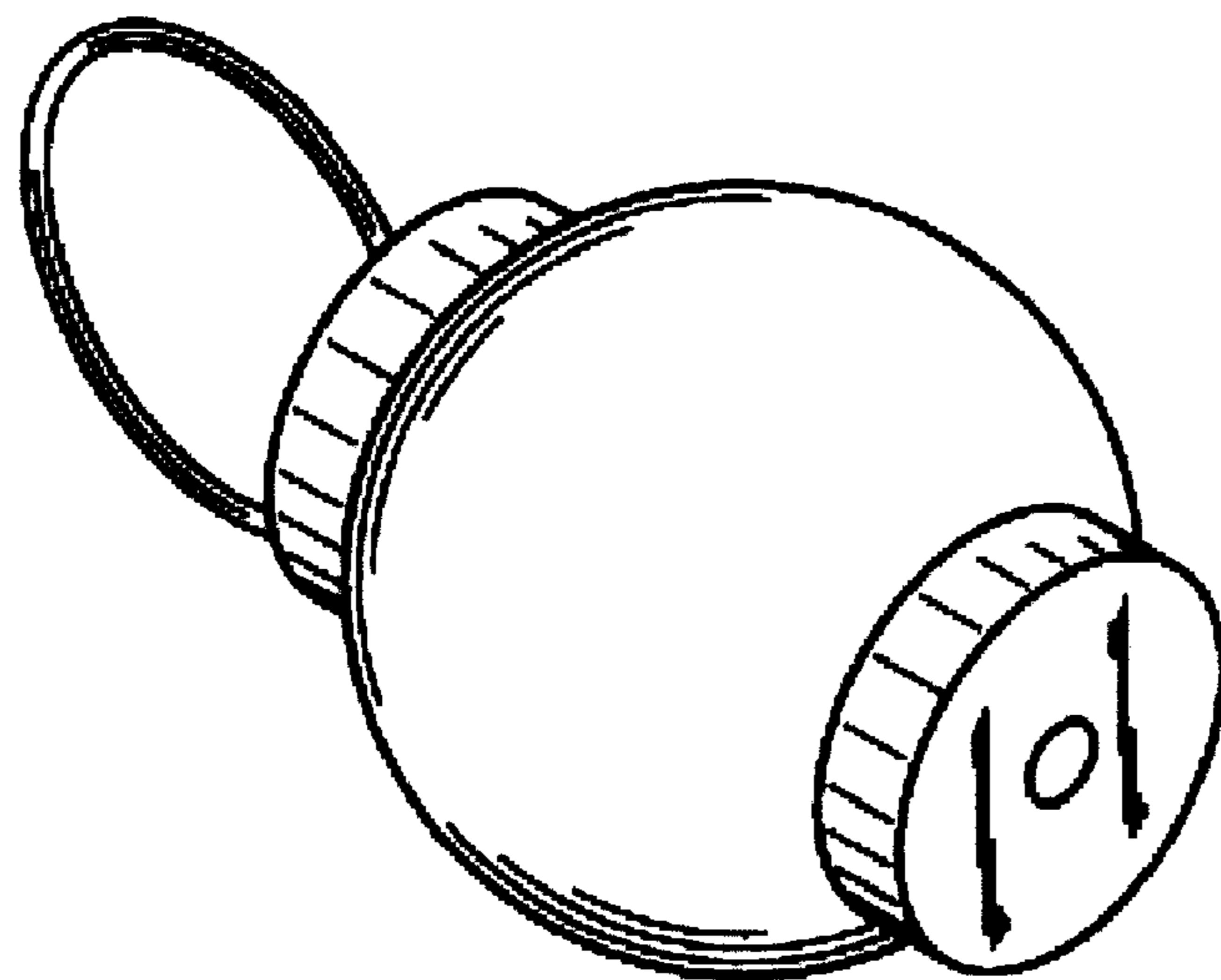
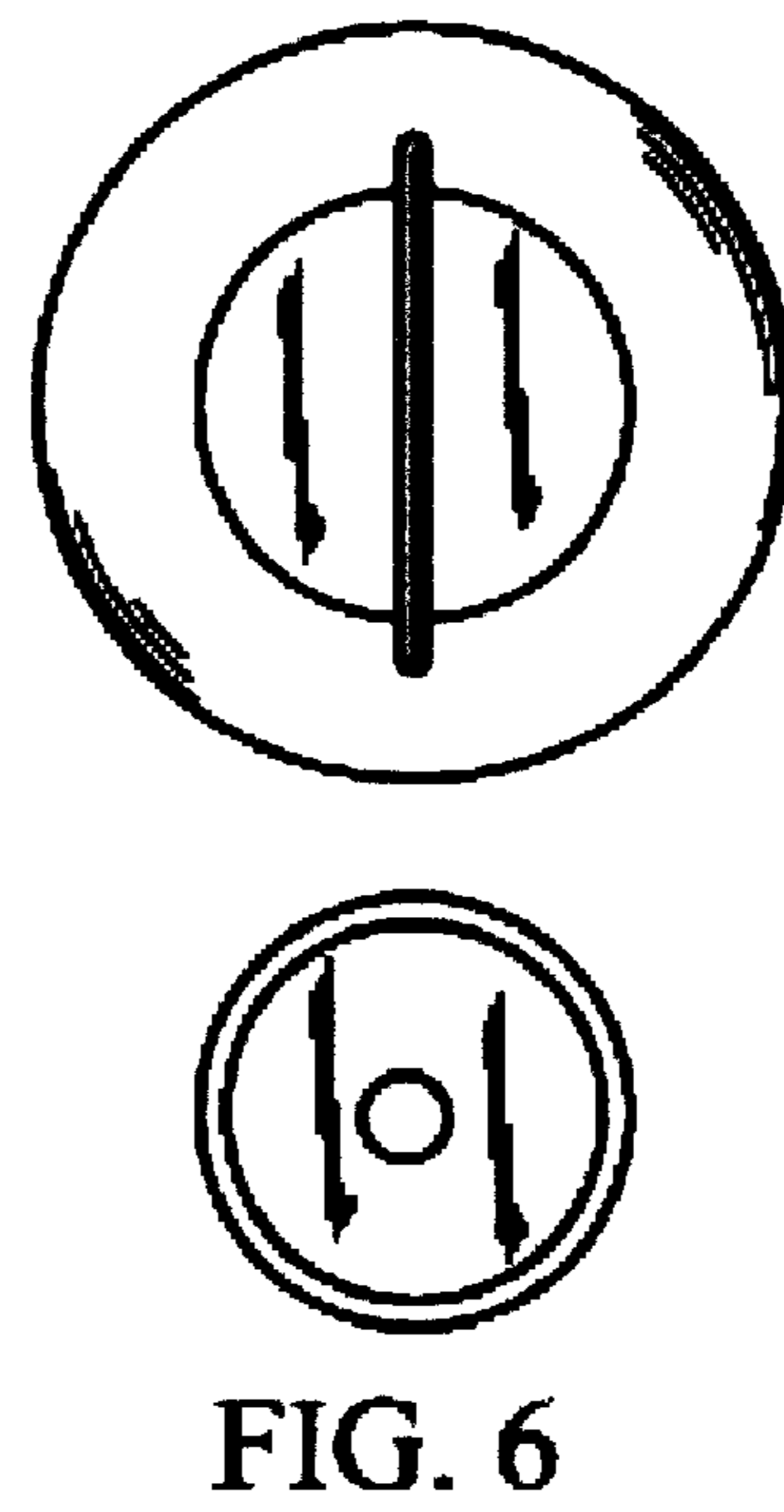
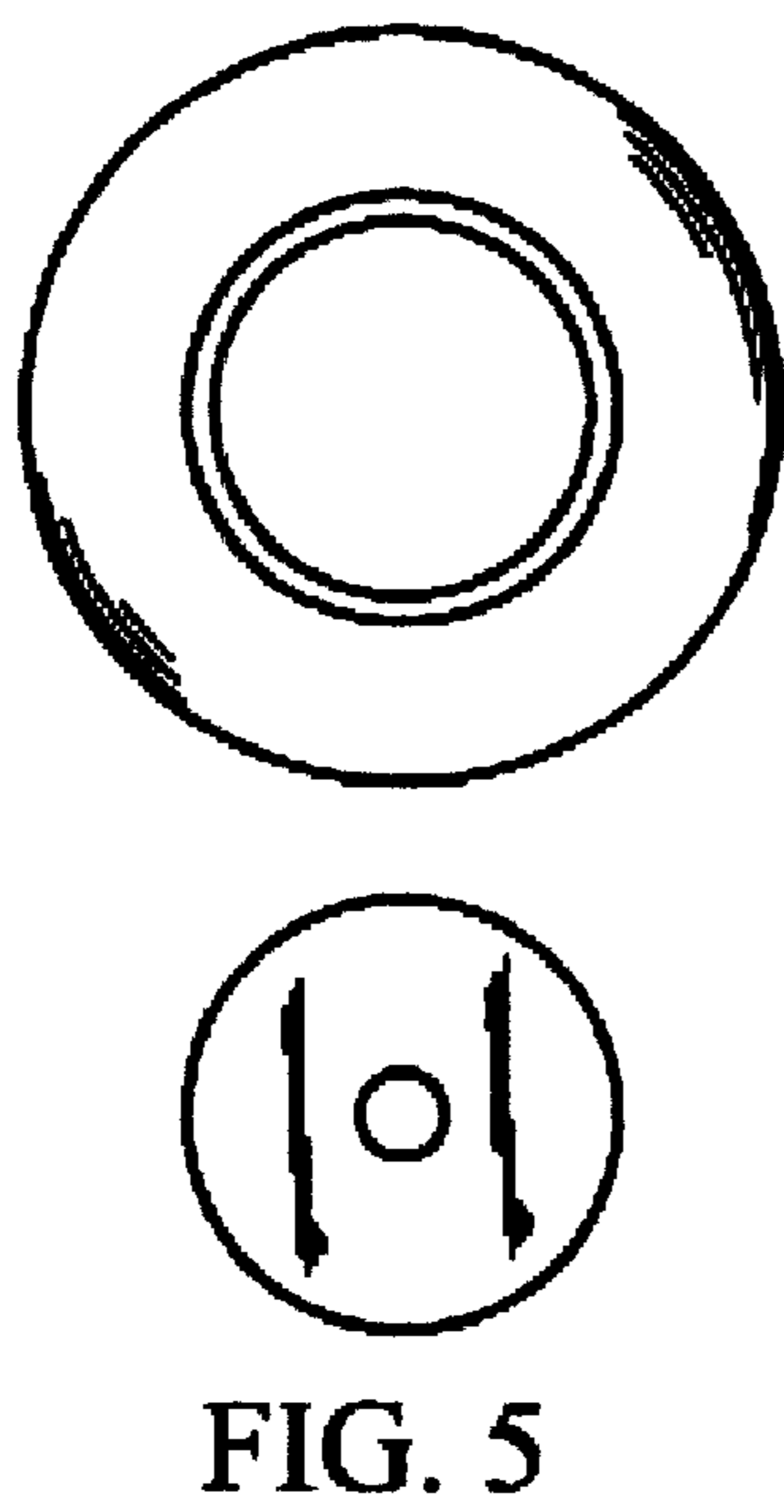
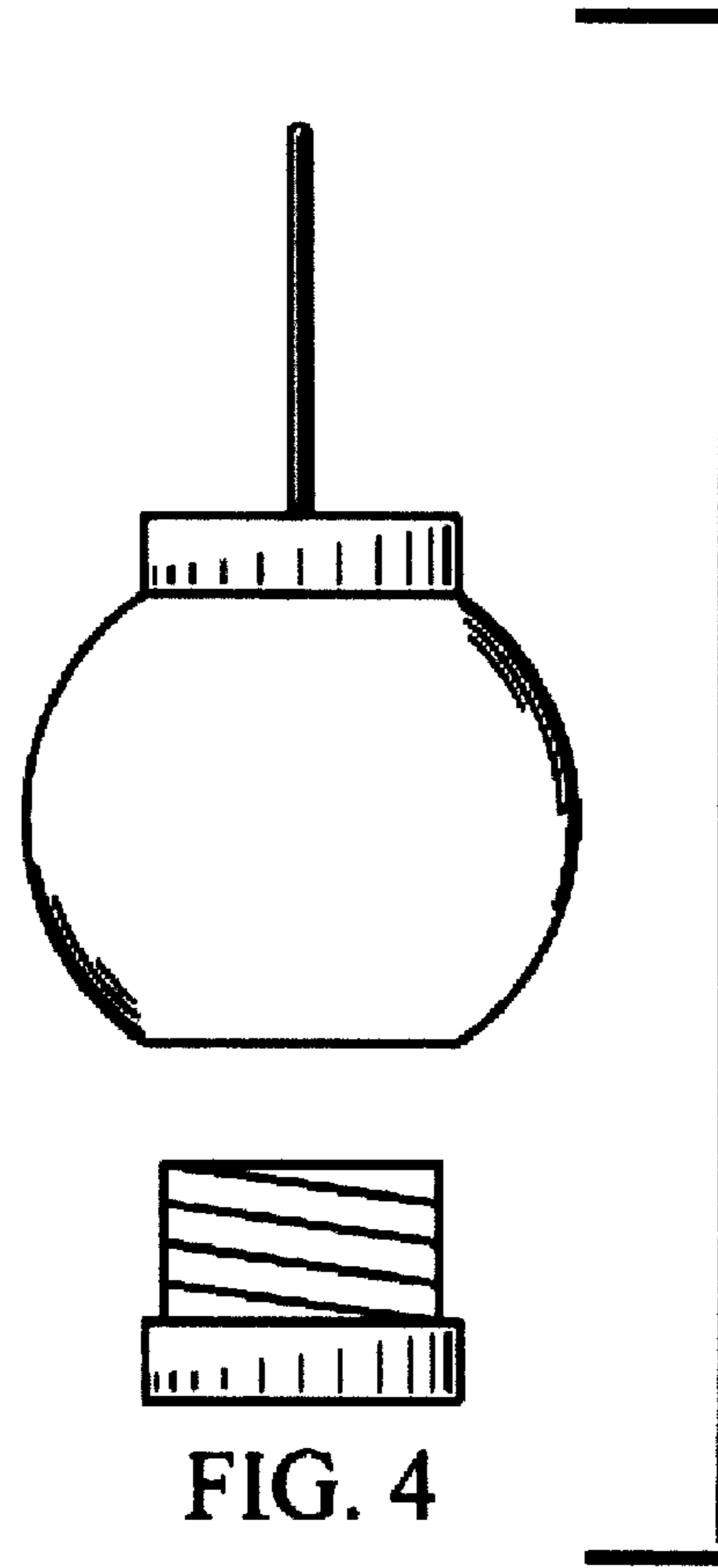
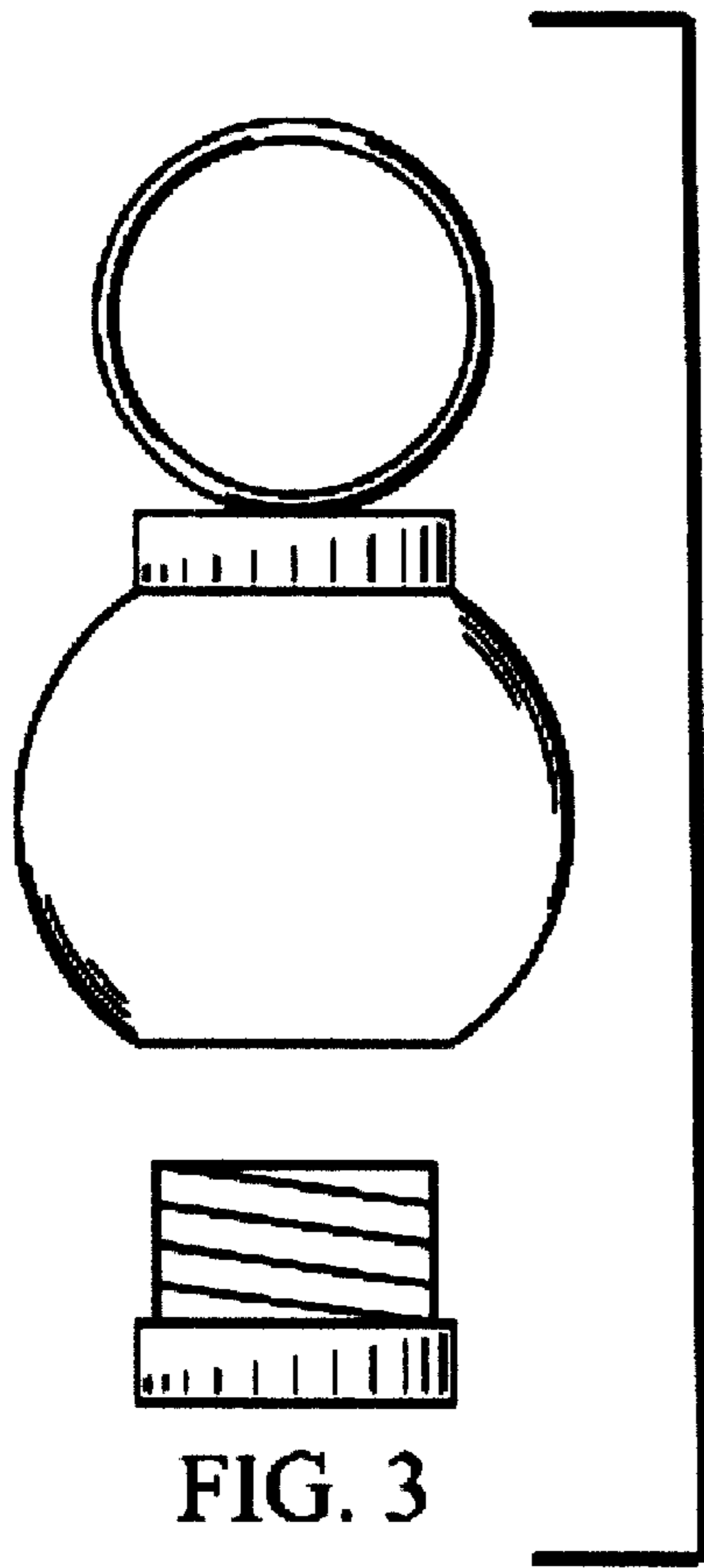

FIG. 2



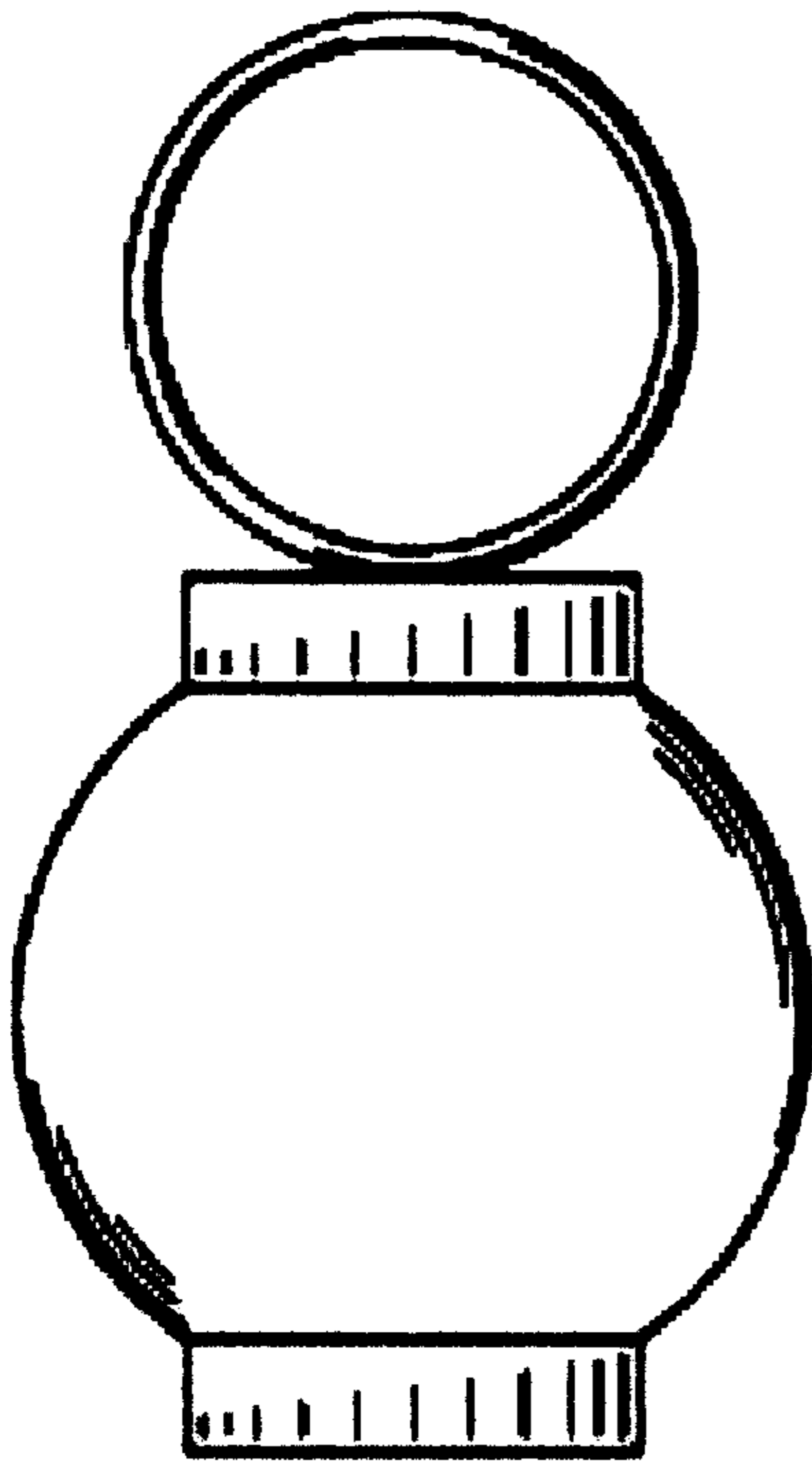

FIG. 7

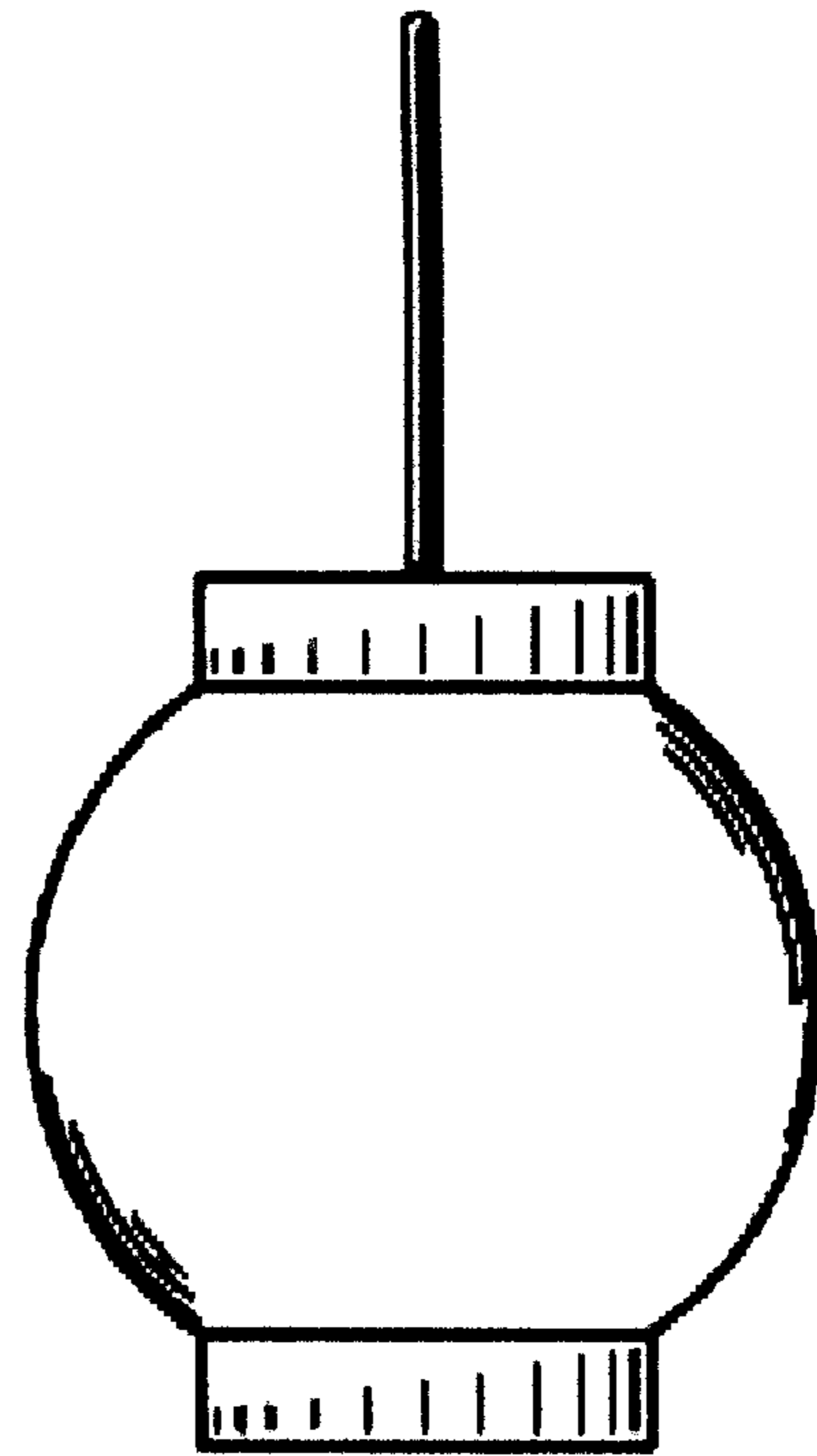

FIG. 8

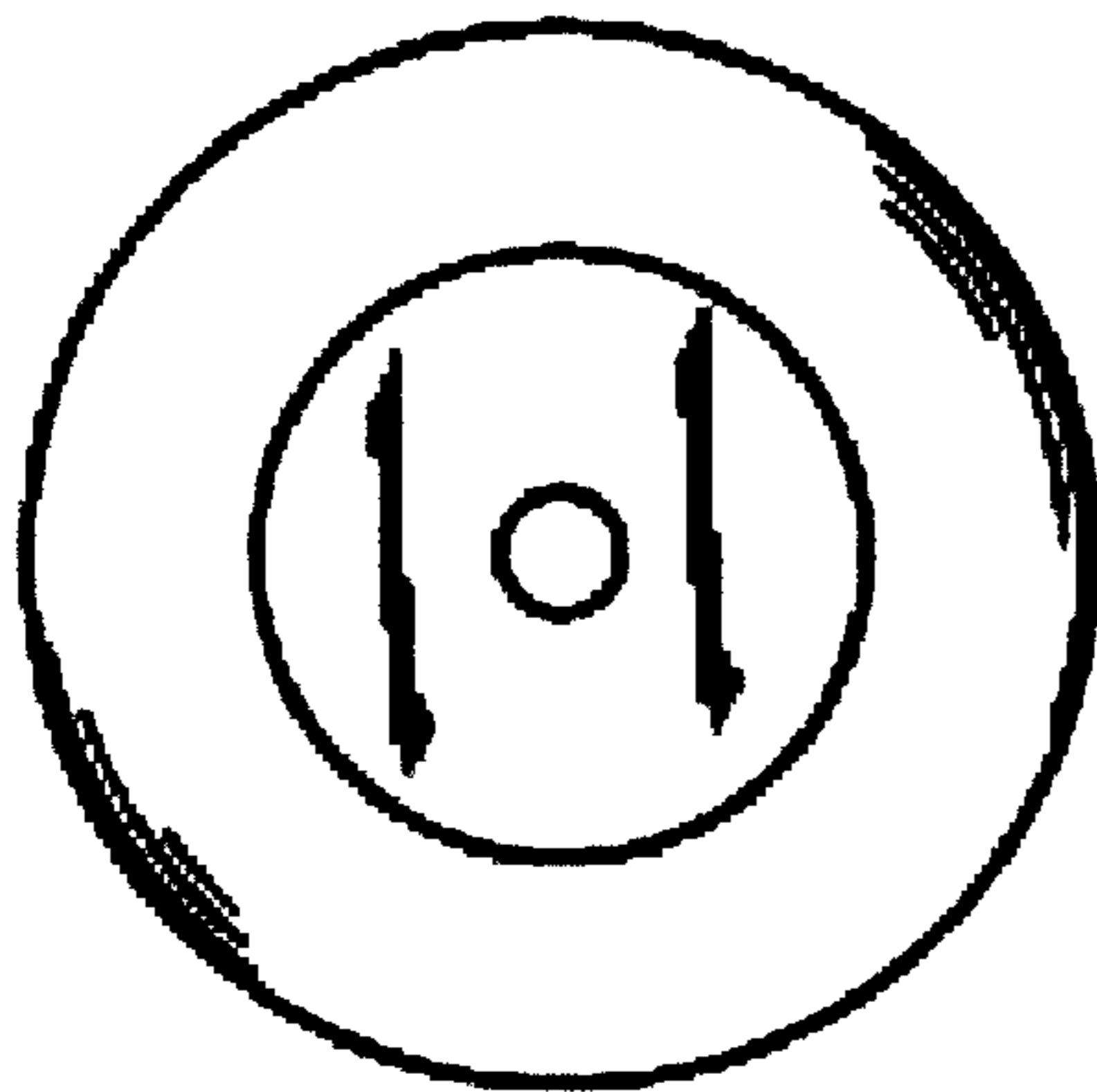

FIG. 9

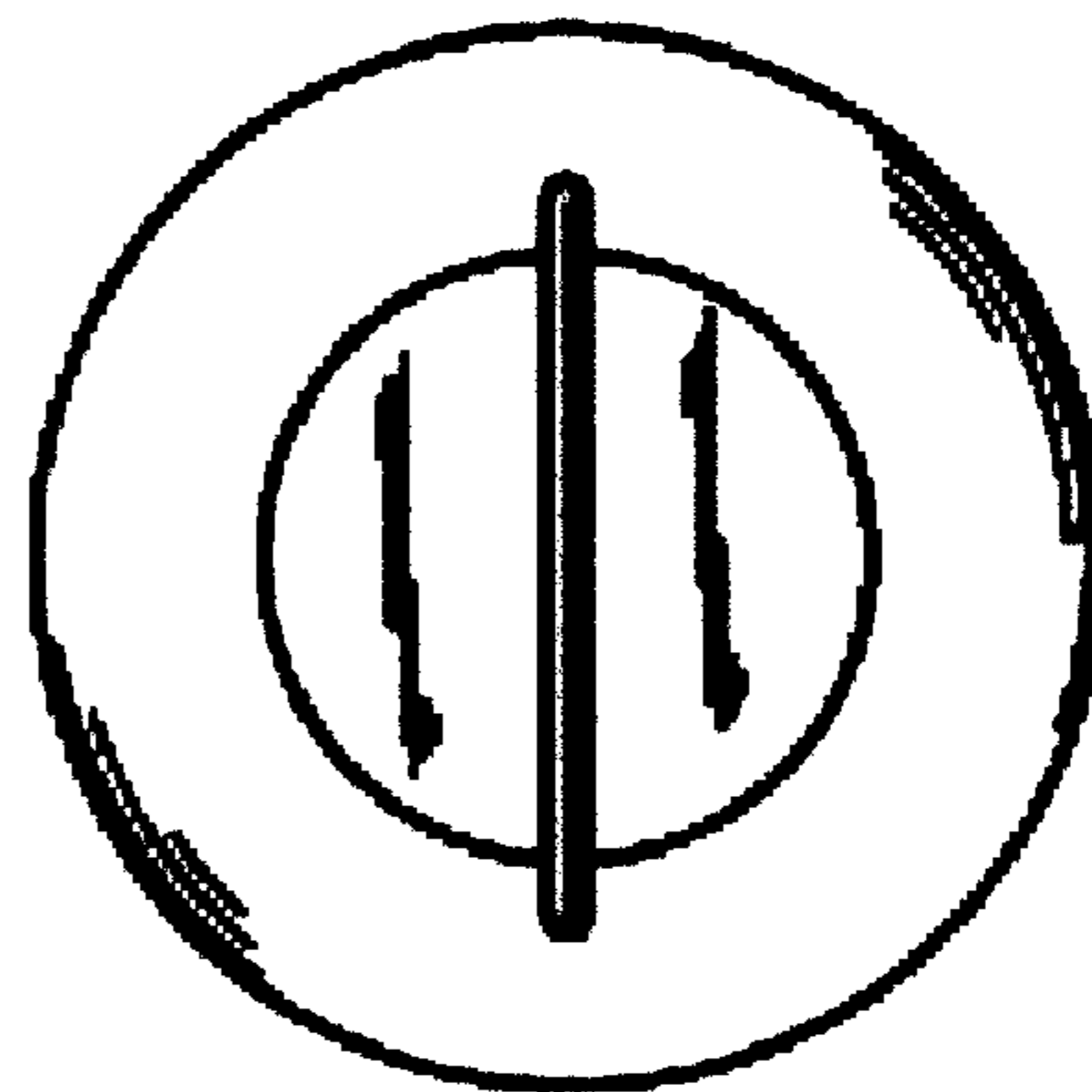

FIG. 10