



US00D531026S

(12) **United States Design Patent**
McMorris

(10) **Patent No.:** **US D531,026 S**

(45) **Date of Patent:** **** Oct. 31, 2006**

(54) **CONTAINER FOR DISPLAY**

(76) **Inventor:** **Ralph E. McMorris**, 1202 Postoffice St., Galveston, TX (US) 77550

(**) **Term:** **14 Years**

(21) **Appl. No.:** **29/236,988**

(22) **Filed:** **Aug. 25, 2005**

(51) **LOC (8) Cl.** **09-03**

(52) **U.S. Cl.** **D9/431; D9/433; D9/754**

(58) **Field of Classification Search** D9/414, D9/415, 418, 430-433, 751-754; 229/120.08, 229/171, 173, 183, 117.09, 117.12, 117.13, 229/117.14; 206/139-141, 822, 161, 427-429, 206/147, 145, 434, 431
See application file for complete search history.

(56) **References Cited**

U.S. PATENT DOCUMENTS

D115,651 S	*	7/1939	Ford et al.	D9/753
2,364,650 A	*	12/1944	Powell	206/195
4,234,081 A	*	11/1980	Champlin	206/147
4,256,226 A	*	3/1981	Stone	206/427
D259,857 S	*	7/1981	Nattrass	D9/432
D263,116 S	*	2/1982	Cain	D9/654
D267,474 S	*	1/1983	Maroszek	D9/418
D267,475 S	*	1/1983	Maroszek et al.	D9/418
4,391,223 A	*	7/1983	Holland et al.	119/499
4,397,393 A	*	8/1983	Pergande et al.	206/549
4,398,631 A	*	8/1983	Graser	206/427

4,399,939 A	*	8/1983	Tunick	229/117.14
D271,944 S	*	12/1983	Wood	D9/416
D316,672 S	*	5/1991	Wood	D9/754
D373,306 S	*	9/1996	Baxter	D9/754
D375,898 S	*	11/1996	Bolton	D9/415

* cited by examiner

Primary Examiner—Stella Reid

Assistant Examiner—Mark Goodwin

(74) *Attorney, Agent, or Firm*—Egbert Law Offices

(57) **CLAIM**

The ornamental design for a container for display, as shown and described.

DESCRIPTION

FIG. 1 is a top perspective view of the container for display showing my new design;
FIG. 2 is a front view thereof;
FIG. 3 is a back view thereof;
FIG. 4 is a side view thereof;
FIG. 5 is an opposite side view thereof;
FIG. 6 is a top plan view thereof;
FIG. 7 is a bottom plan view thereof; and,
FIG. 8 is another perspective view thereof, showing the container in open position.

The broken line showing of the contents of the container are for illustrative purposes only and forms no part of the claimed design.

1 Claim, 3 Drawing Sheets

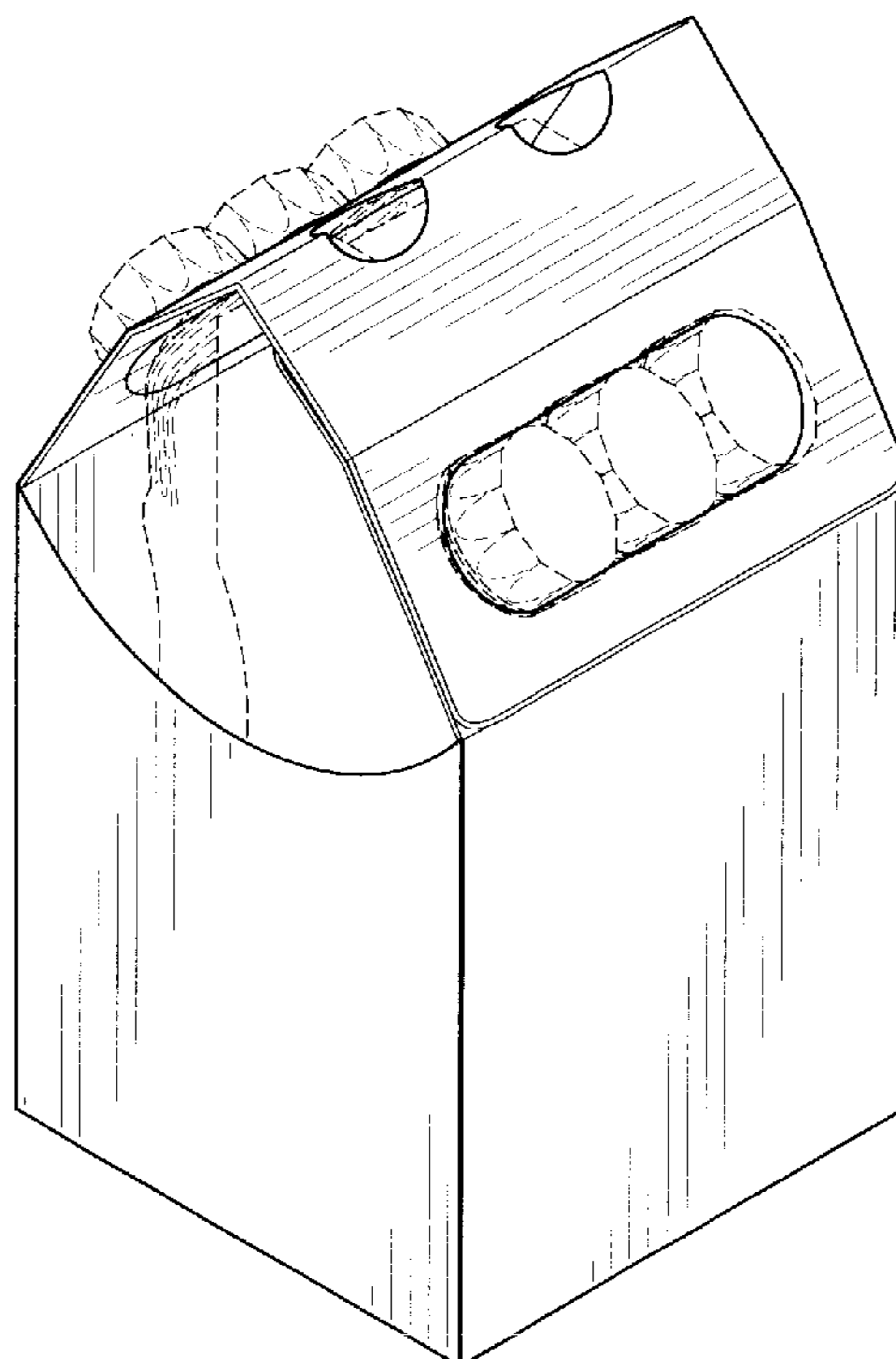

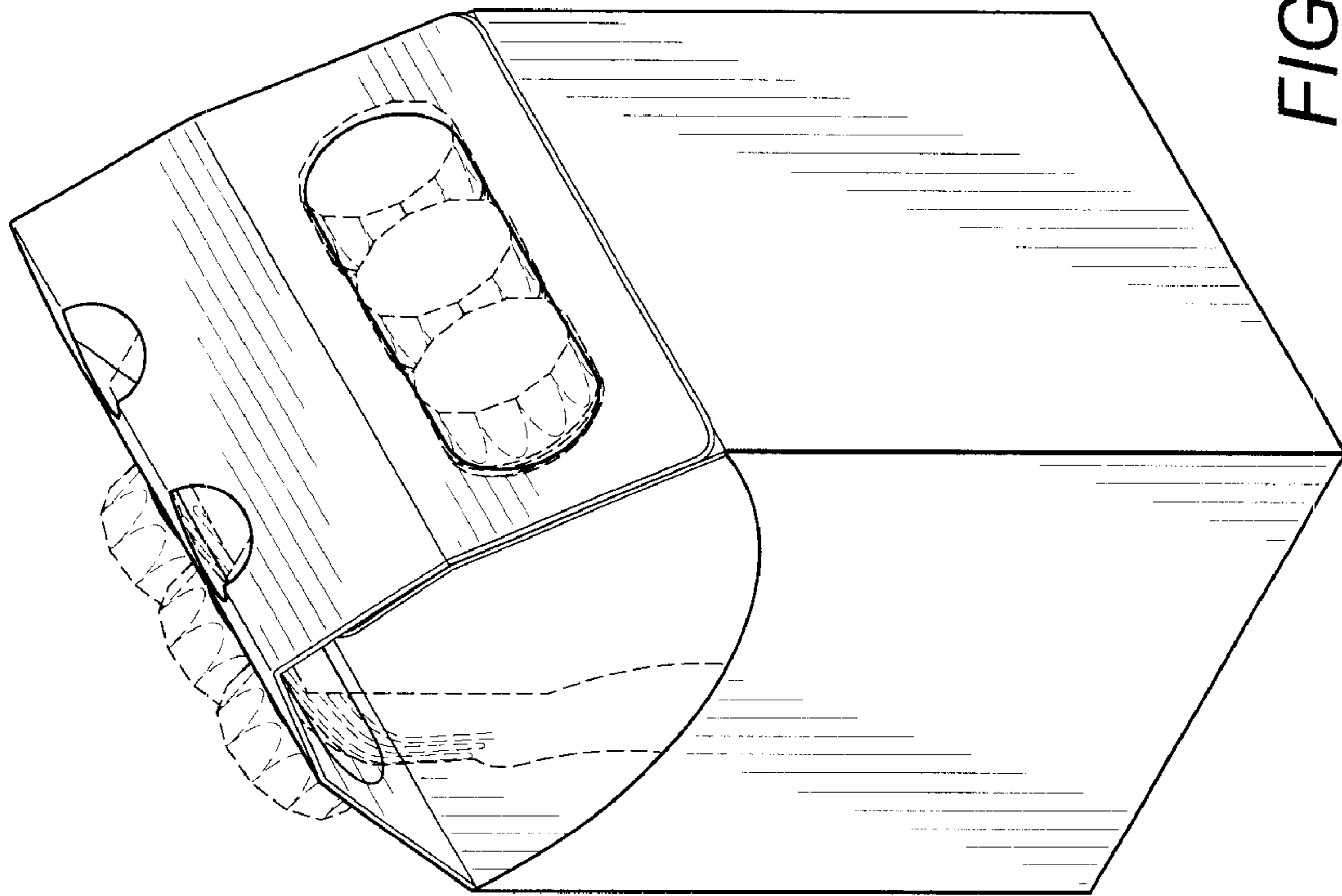

FIG. 1

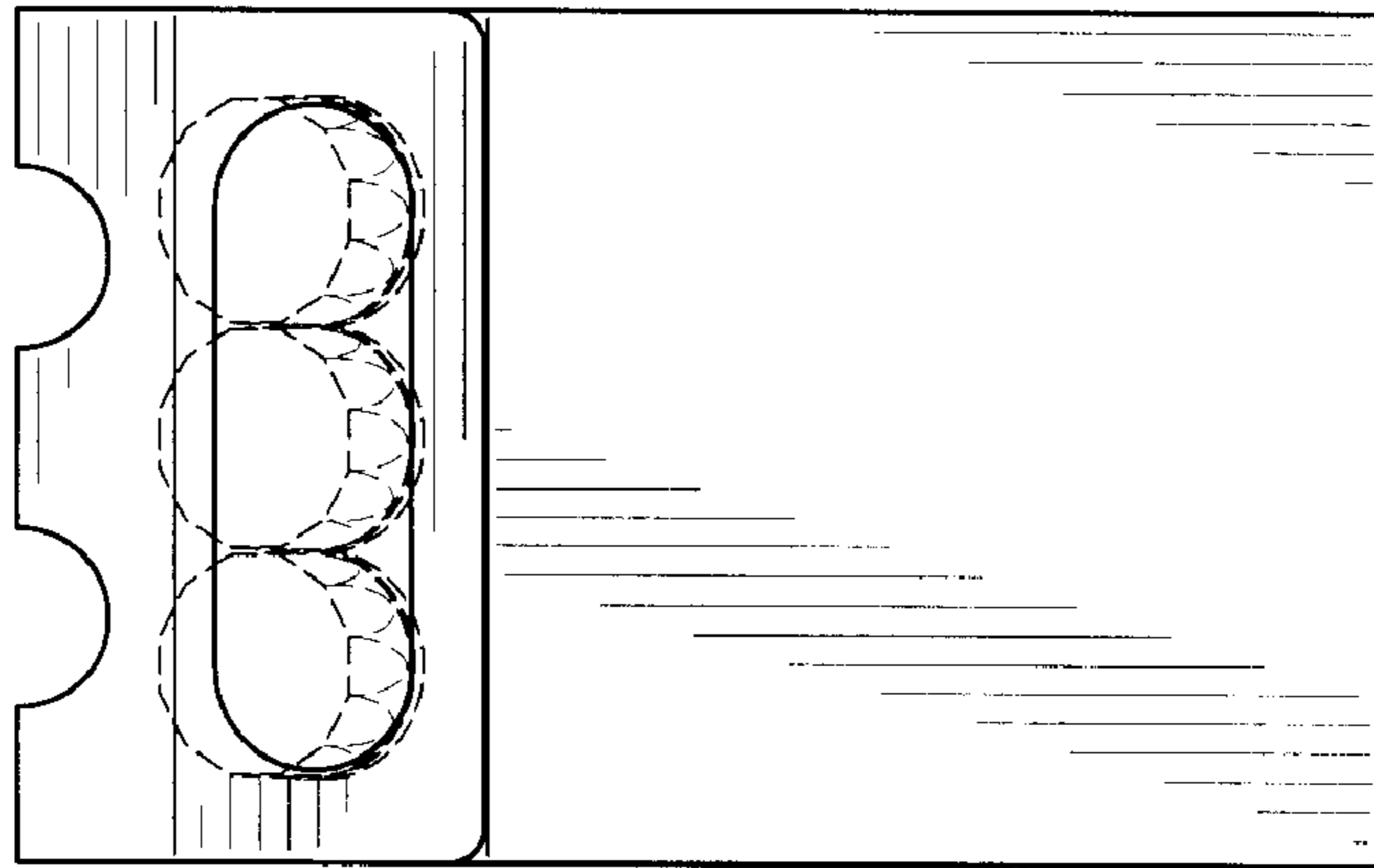

FIG. 2

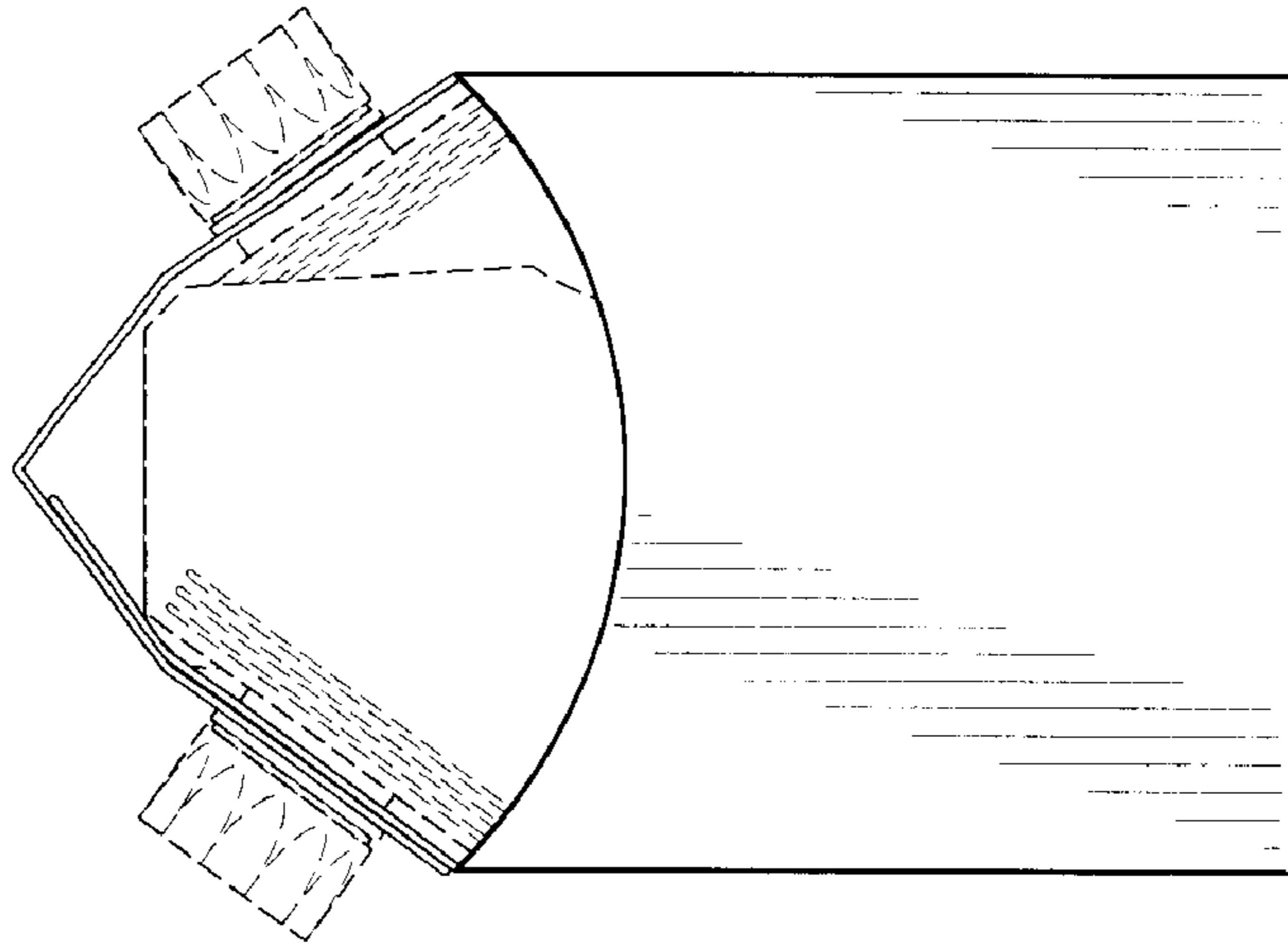

FIG. 3

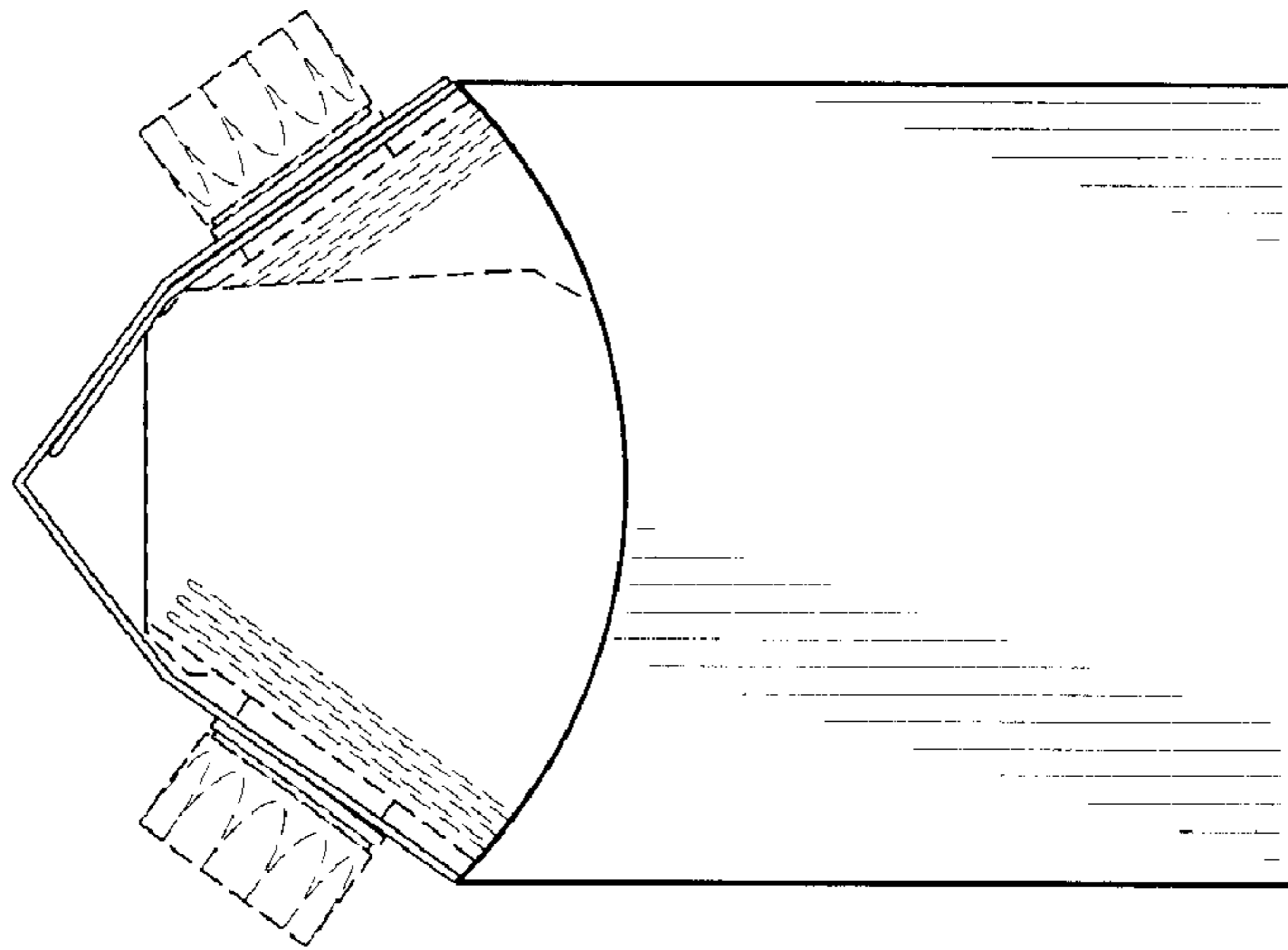

FIG. 4

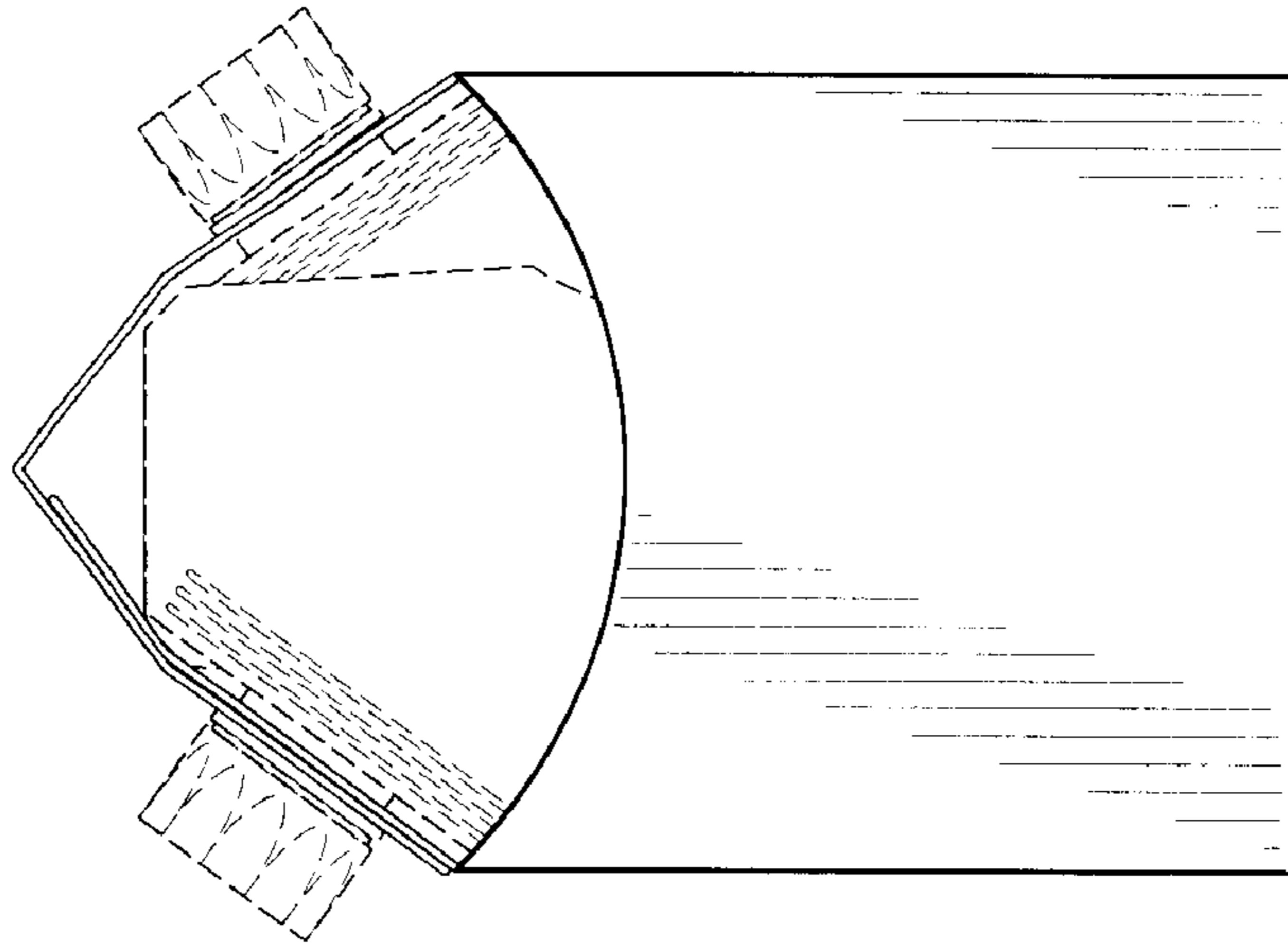

FIG. 5

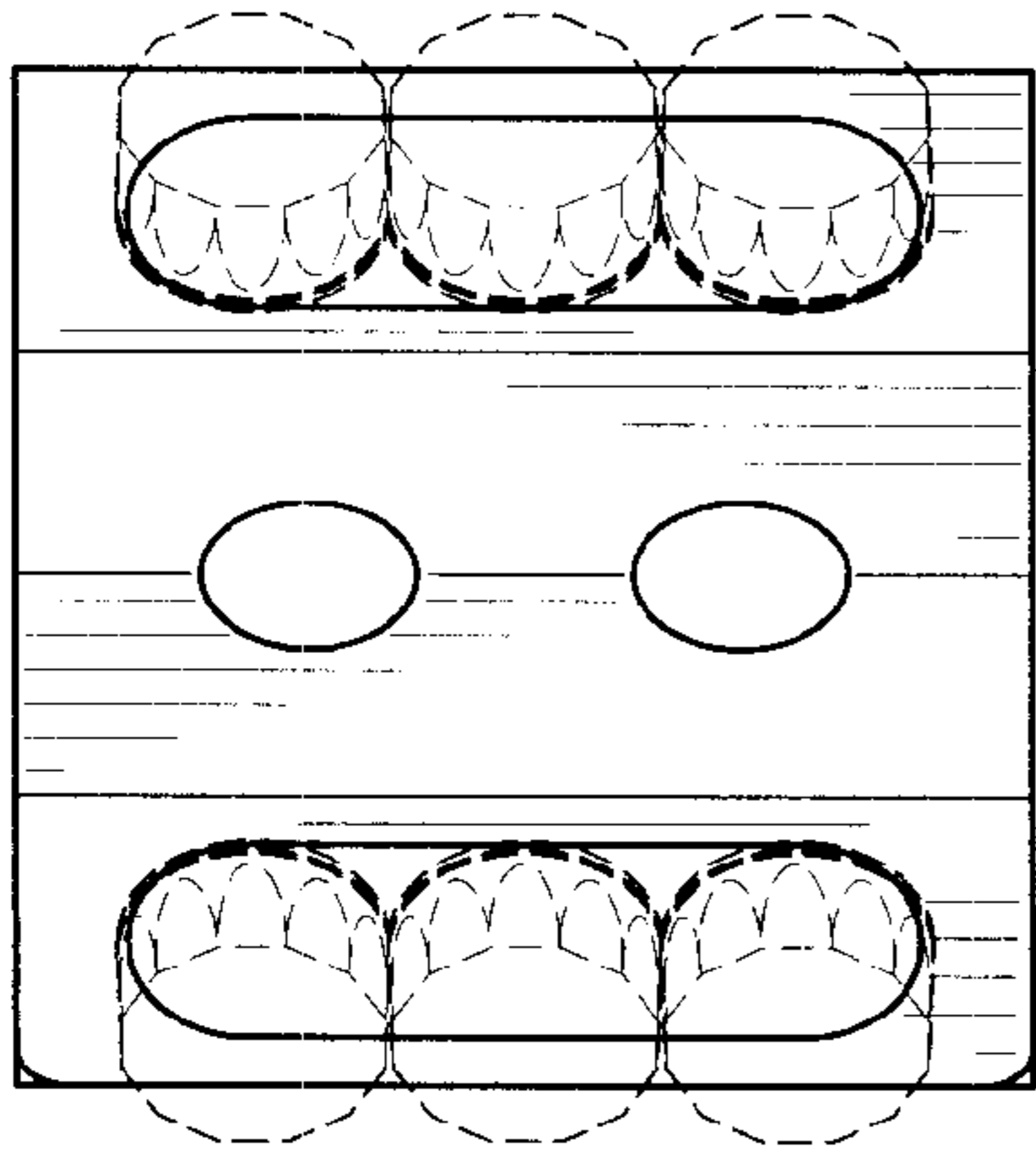

FIG. 6

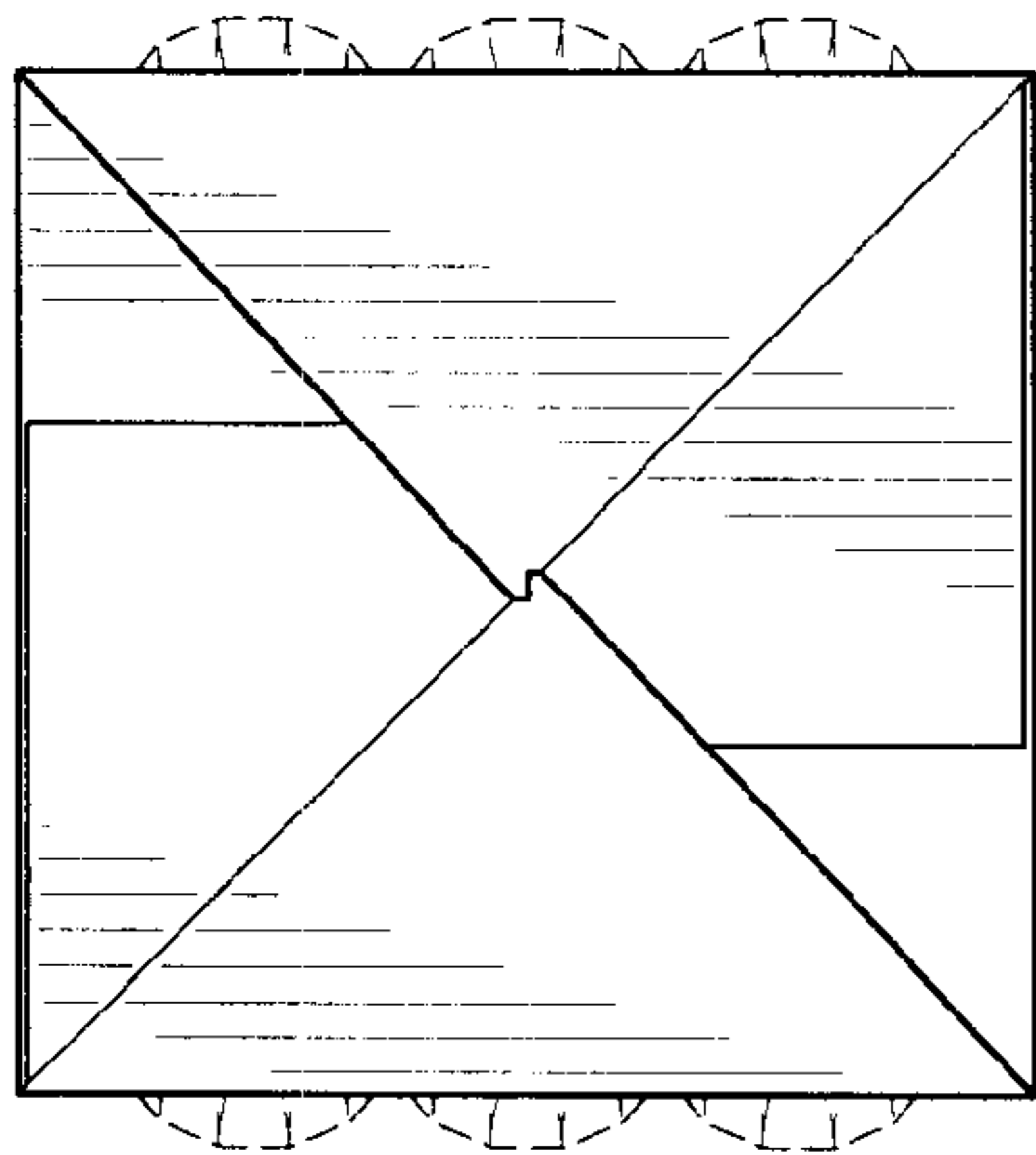

FIG. 7

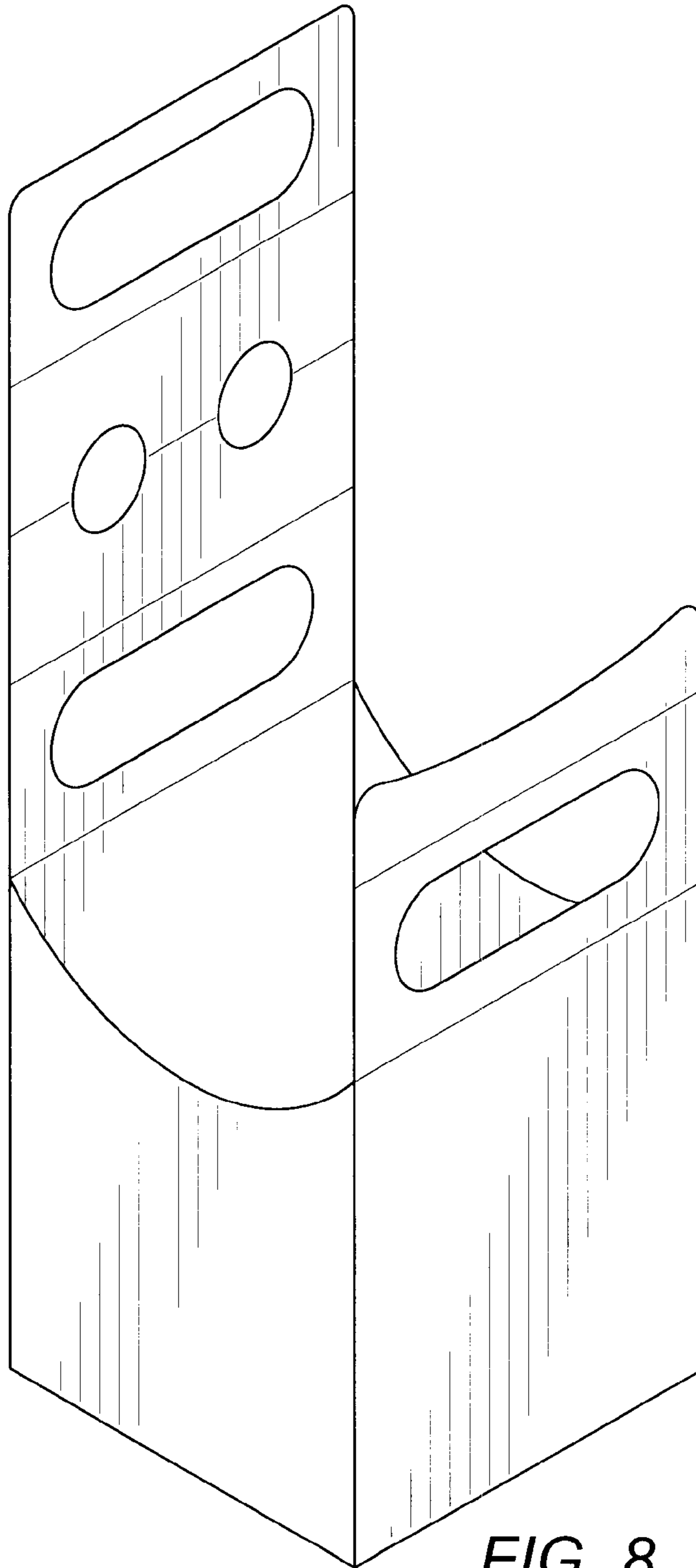

FIG. 8