



US00D530986S

(12) **United States Design Patent**  
**Lago-Arenas**

(10) **Patent No.:** **US D530,986 S**  
(45) **Date of Patent:** **\*\* Oct. 31, 2006**

(54) **CUTLERY SET**

(75) Inventor: **Marta Lago-Arenas**, Stuttgart (DE)

(73) Assignee: **Royal College of Art** (GB)

(\*\*) Term: **14 Years**

(21) Appl. No.: **29/214,465**

(22) Filed: **Oct. 1, 2004**

(30) **Foreign Application Priority Data**

Sep. 7, 2004 (EM) ..... 000226634

(51) **LOC (8) Cl.** ..... **07-03**

(52) **U.S. Cl.** ..... **D7/645**

(58) **Field of Classification Search** ..... D7/368,  
D7/401.2, 575, 642-664, 669, 676, 683, 688-692;  
30/137, 141, 142, 147-150, 322-329, 340,  
30/342-345; 416/70 R  
See application file for complete search history.

(56) **References Cited**

**U.S. PATENT DOCUMENTS**

33,703 A	11/1861	Hardie	
1,053,387 A *	2/1913	Hawley	30/147
D209,704 S *	12/1967	Svend	D7/653
D216,482 S *	1/1970	Wentzel	D7/653
D234,017 S *	12/1974	Christain	D7/653
4,317,284 A *	3/1982	Prindle	30/147
4,332,409 A	6/1982	Stachowicz	
4,524,512 A *	6/1985	Formo et al.	30/147
D284,442 S *	7/1986	Chan	D7/645
4,995,154 A *	2/1991	Bamber	30/147
D318,600 S *	7/1991	Lillelund et al.	D7/643
D347,975 S *	6/1994	Zeller	D7/645
5,327,650 A *	7/1994	Rojas	30/147
5,419,049 A *	5/1995	MacArthur-Onslow	30/322
D362,160 S *	9/1995	Brabeck et al.	D7/645
5,590,472 A *	1/1997	Yaakov	30/323
D385,159 S *	10/1997	Gagnon et al.	D7/650
D401,481 S *	11/1998	Boilard et al.	D7/643
5,845,403 A *	12/1998	Nivin	30/147

(Continued)

**FOREIGN PATENT DOCUMENTS**

WO WO 2005030016 A1 \* 4/2005

*Primary Examiner*—Cathron C. Brooks

*Assistant Examiner*—Ricky Pham

(74) *Attorney, Agent, or Firm*—Andrus, Scales, Starke & Sawall, LLP

(57) **CLAIM**

The ornamental design for a cutlery set, as shown and described.

**DESCRIPTION**

FIG. 1 is a top view of an assembled cutlery set incorporating my new design;  
 FIG. 2 is a bottom view of the cutlery set;  
 FIG. 3 is a side view of the cutlery set, the view from the other side being a mirror image;  
 FIG. 4 is a view of one end of the cutlery set;  
 FIG. 5 is a view from the other end of the cutlery set;  
 FIG. 6 is a perspective view of the spoon of the cutlery set shown in FIG. 1 shown separately for ease of illustration;  
 FIG. 7 is a top view of the spoon;  
 FIG. 8 is a bottom view of the spoon;  
 FIG. 9 is a side view of the spoon, the view from the other side being a mirror image;  
 FIG. 10 is a view from one end of the spoon;  
 FIG. 11 is a view from the other end of the spoon;  
 FIG. 12 is a perspective view of the fork of the cutlery set shown in FIG. 1 shown separately for ease of illustration;  
 FIG. 13 is a top view of the fork;  
 FIG. 14 is a bottom view of the fork;  
 FIG. 15 is a side view of the fork, the view from the other side being a mirror image;  
 FIG. 16 is a view from one end of the fork;  
 FIG. 17 is a view from the other end of the fork;  
 FIG. 18 is a perspective view of the knife of the cutlery set shown in FIG. 1 shown separately for ease of illustration;  
 FIG. 19 is a top view of the knife;  
 FIG. 20 is a bottom view of the knife; and,  
 FIG. 21 is a side view of the knife, the view from the other side being a mirror image.

**1 Claim, 7 Drawing Sheets**

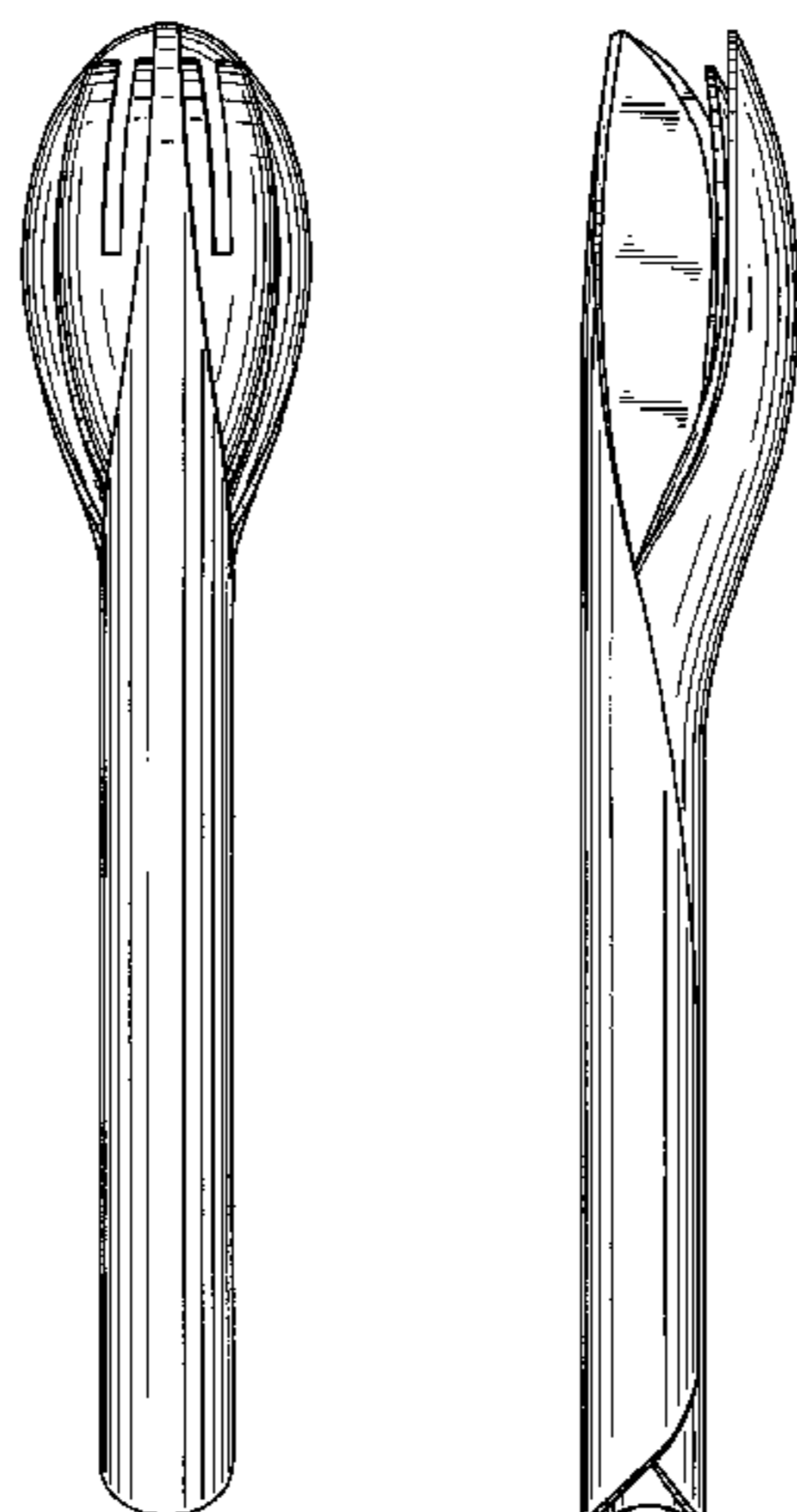



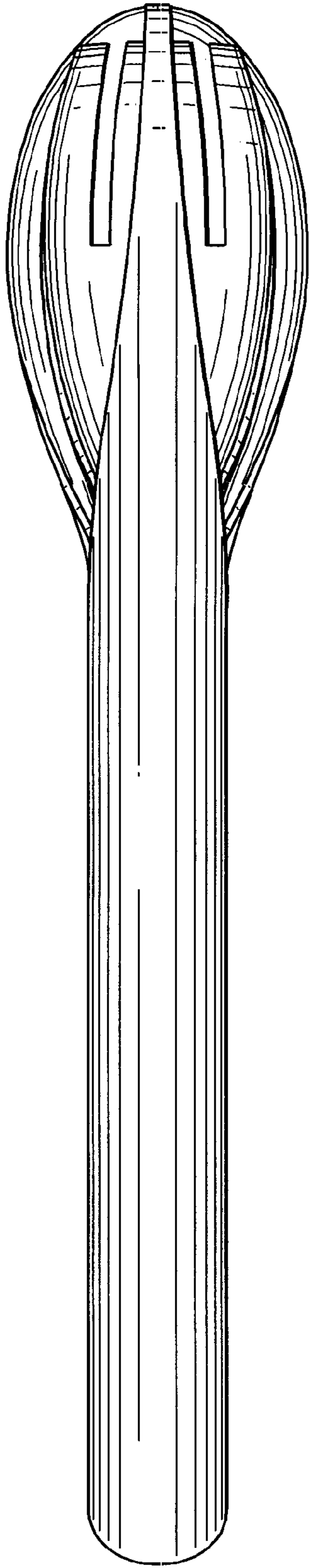

FIG. 1

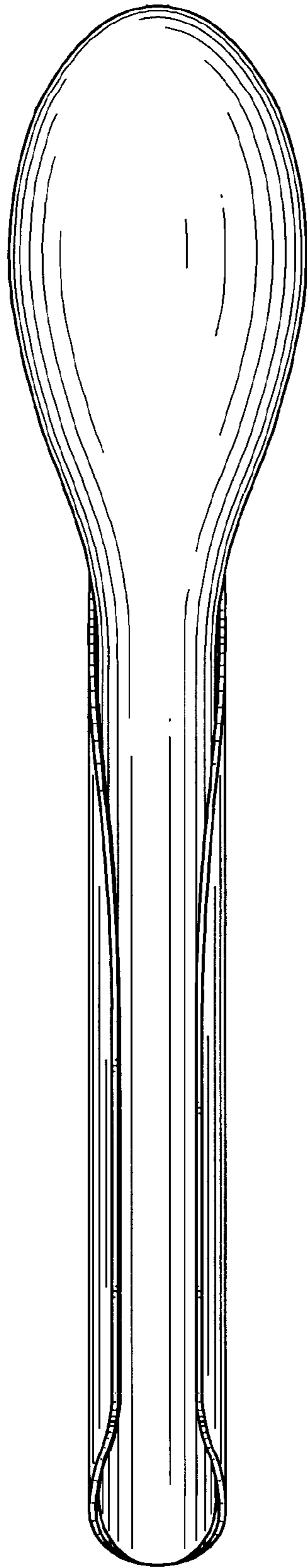

FIG. 2

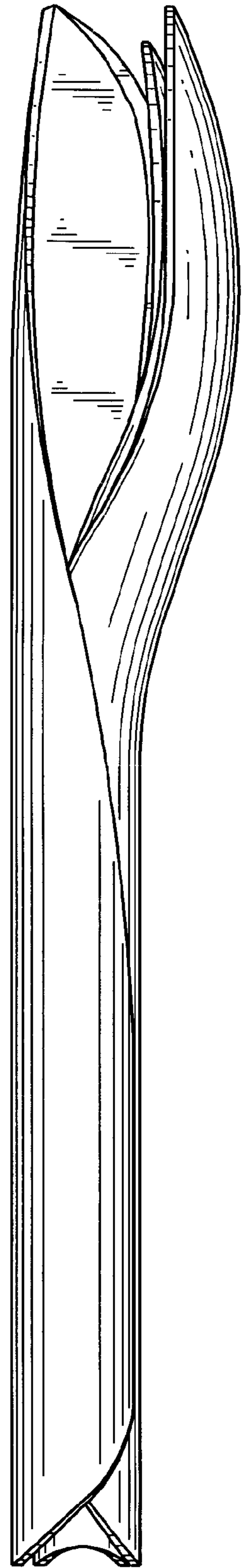

FIG. 3

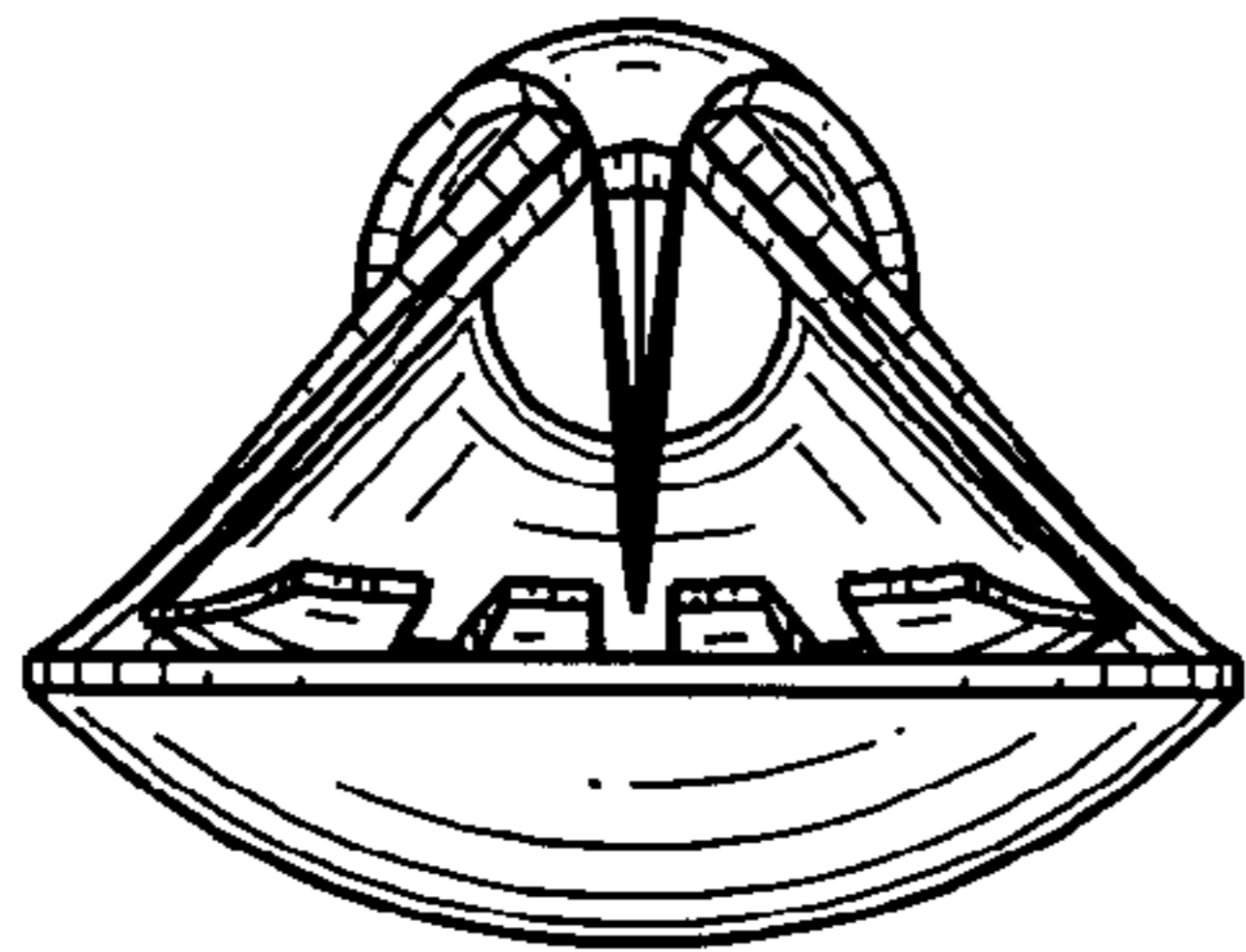

FIG. 4

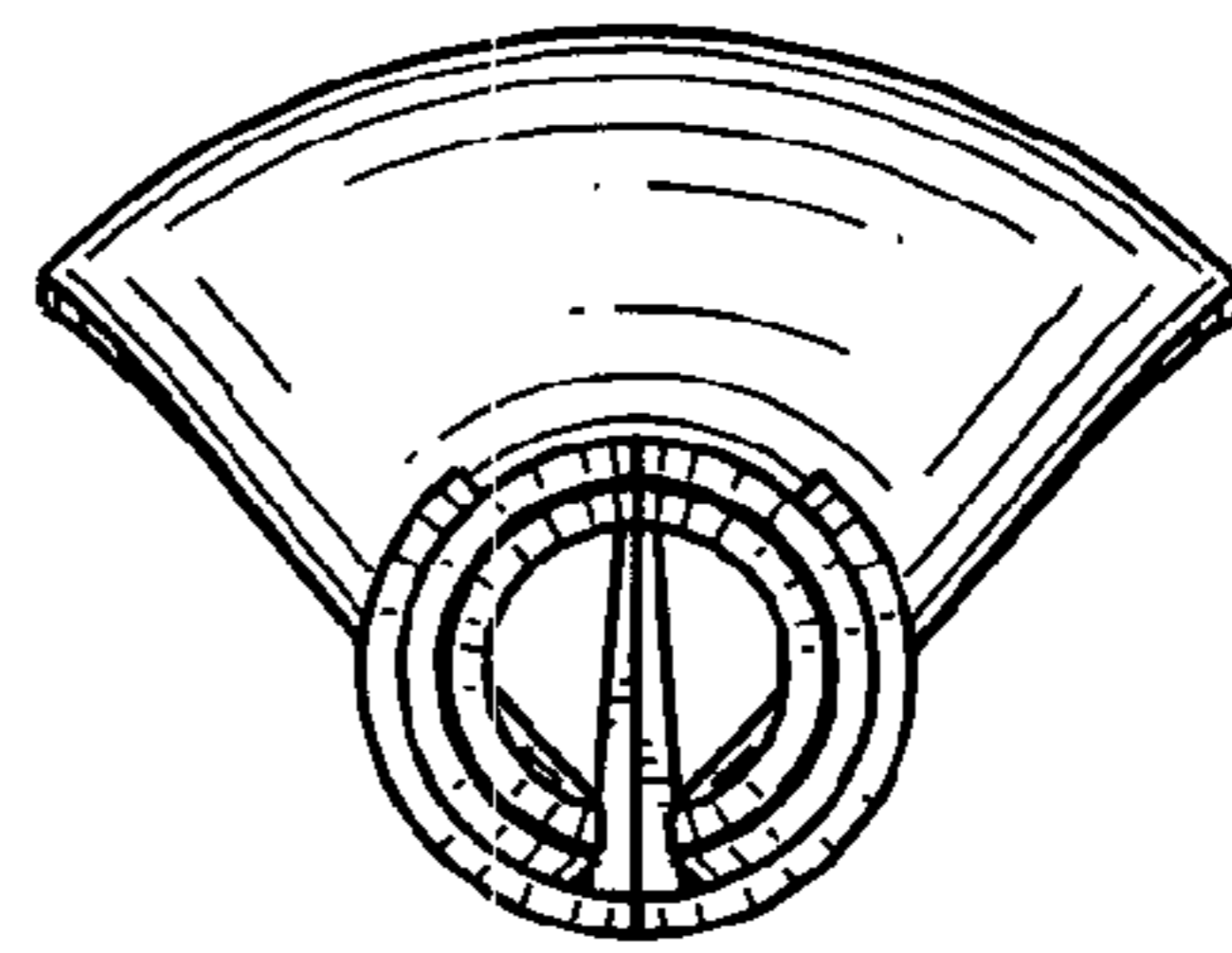

FIG. 5

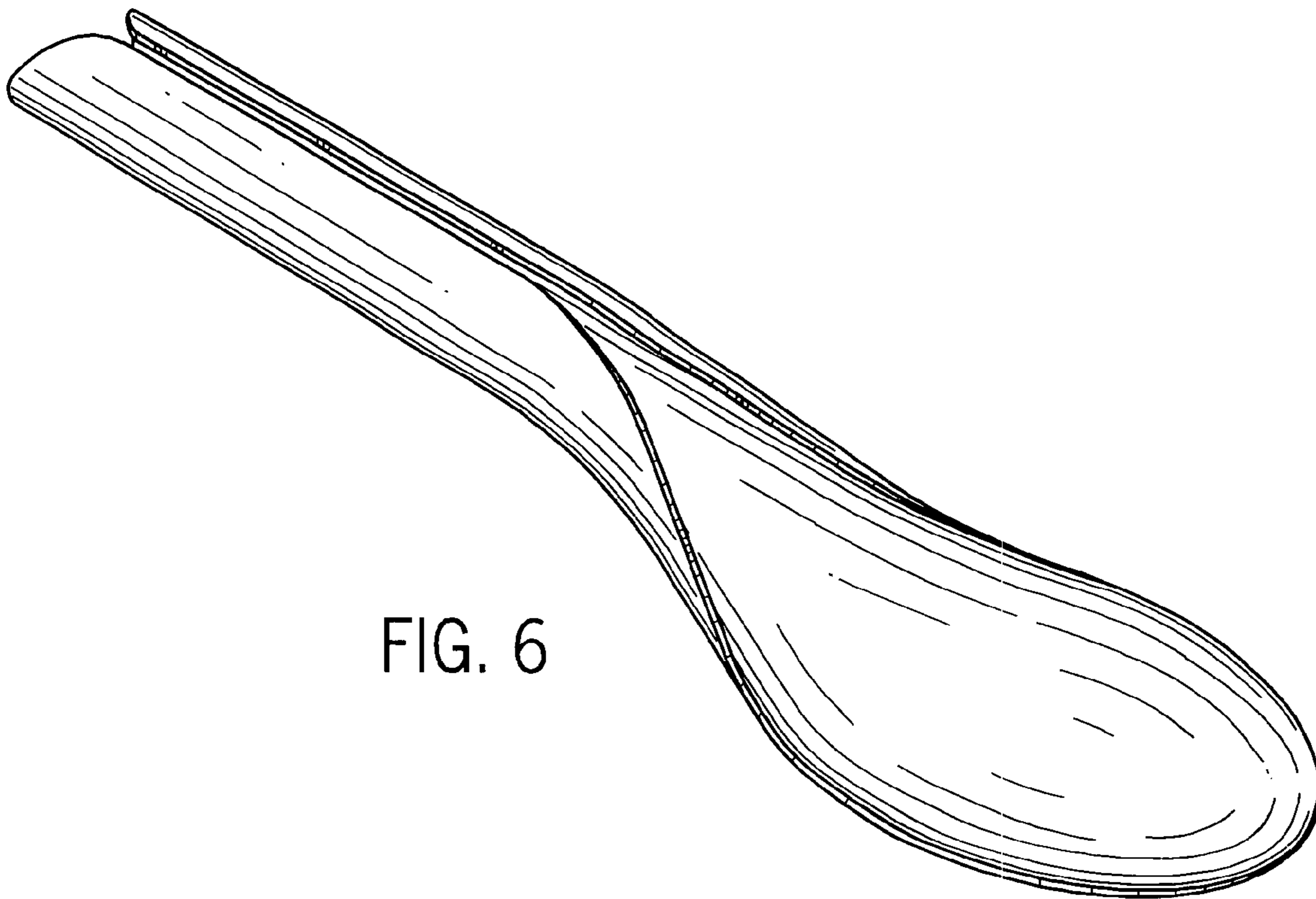

FIG. 6

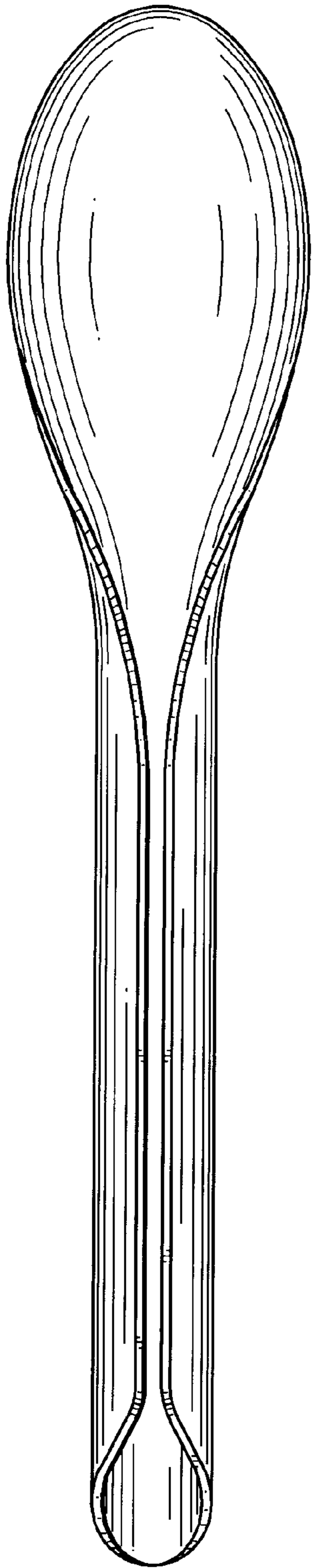

FIG. 7

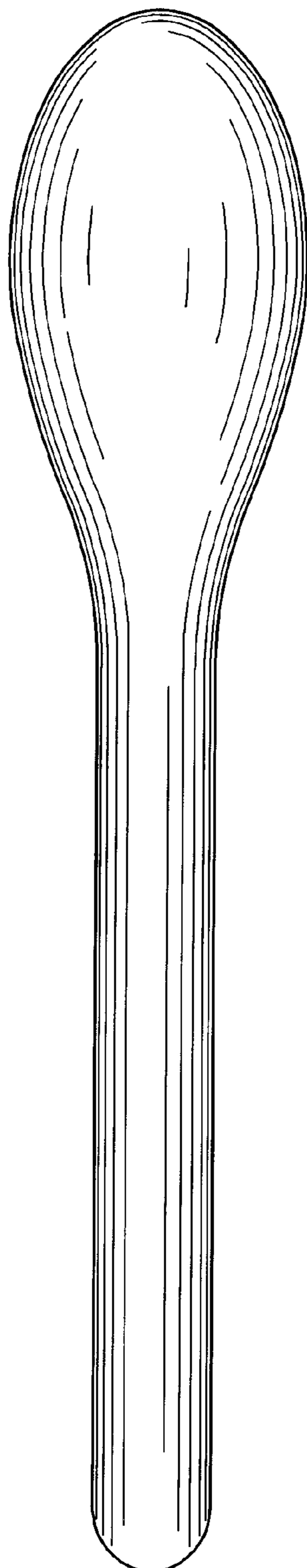

FIG. 8

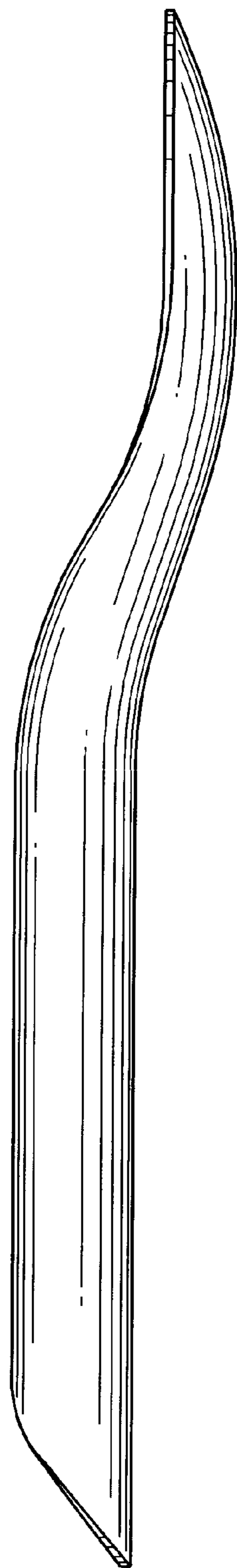

FIG. 9

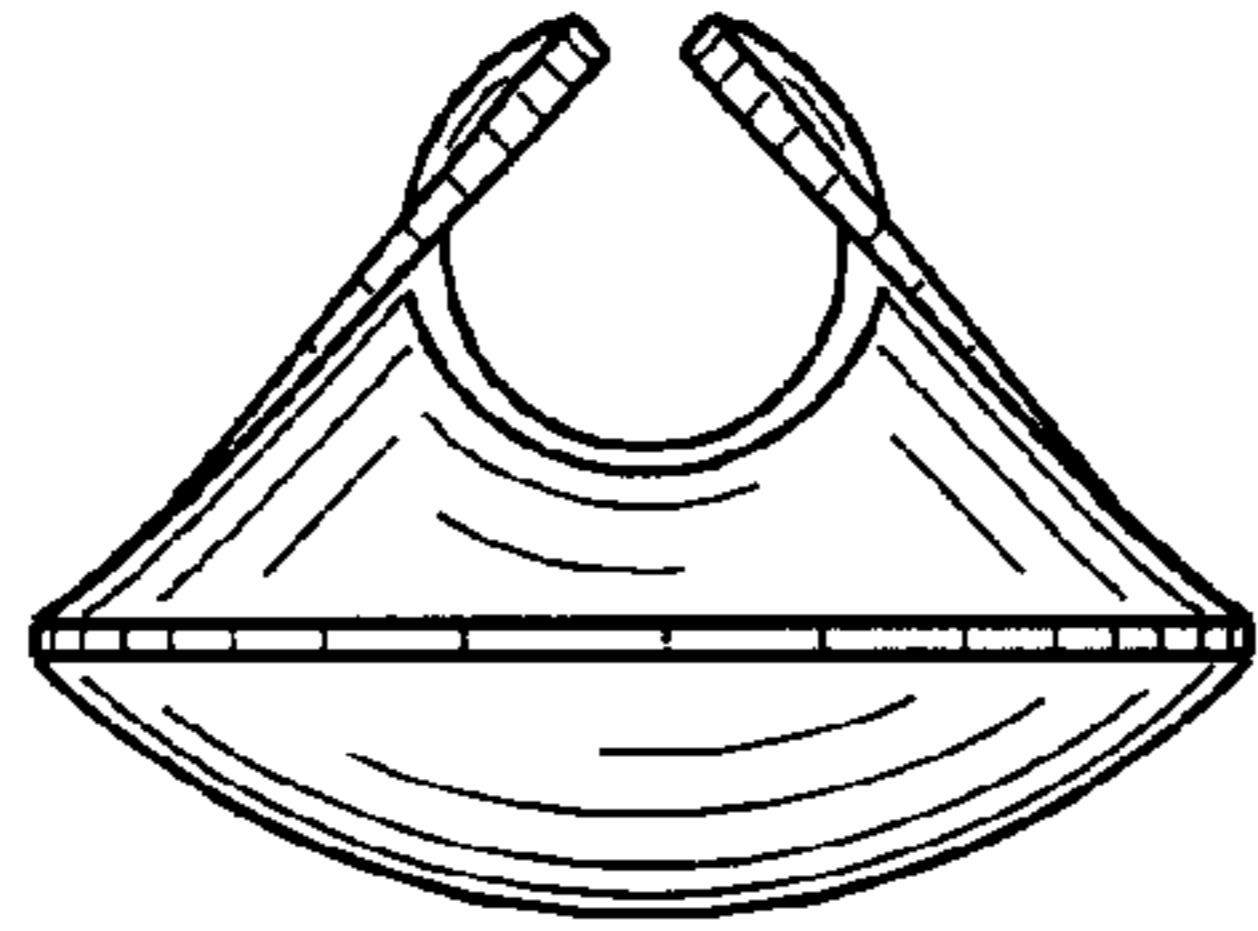

FIG. 10

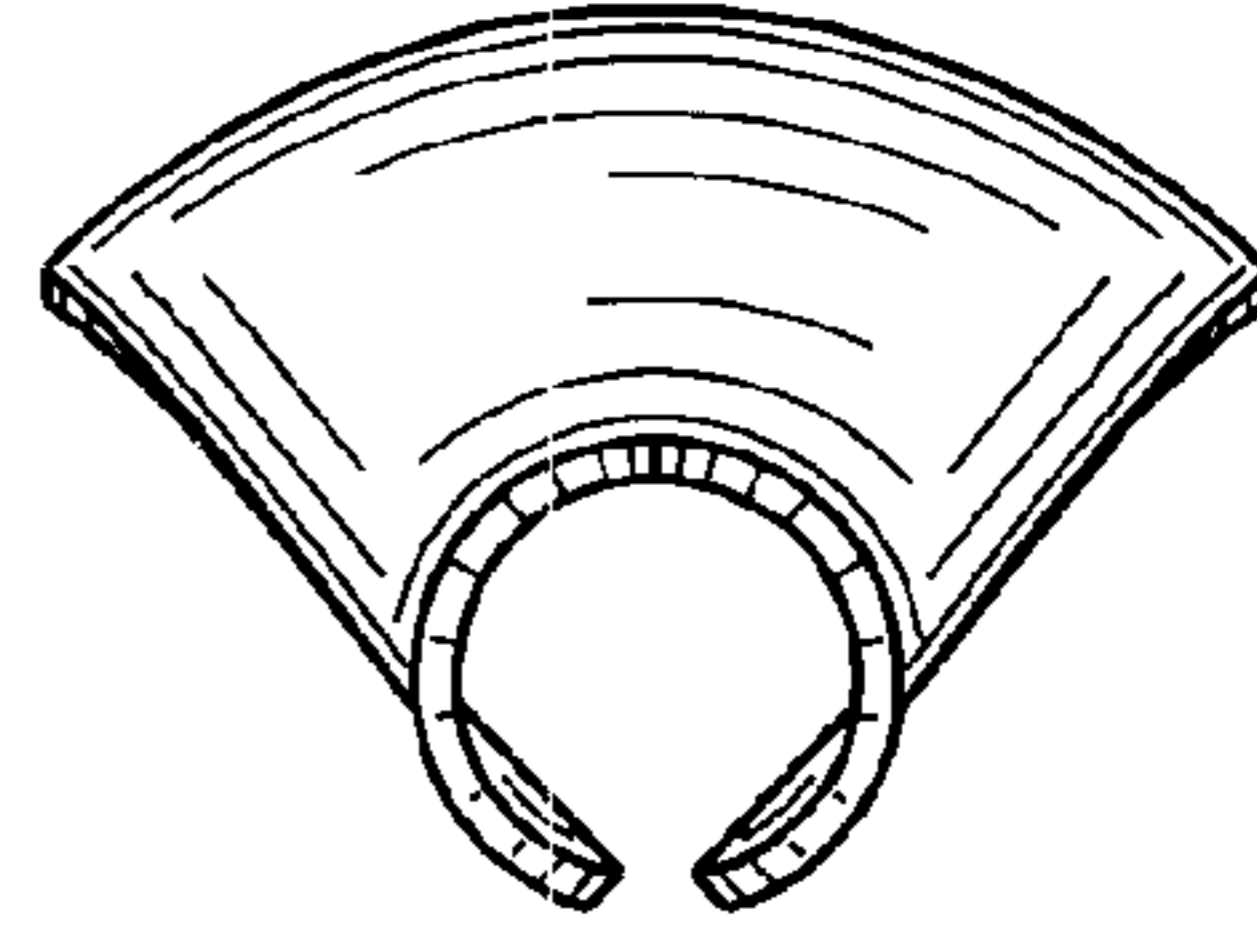

FIG. 11

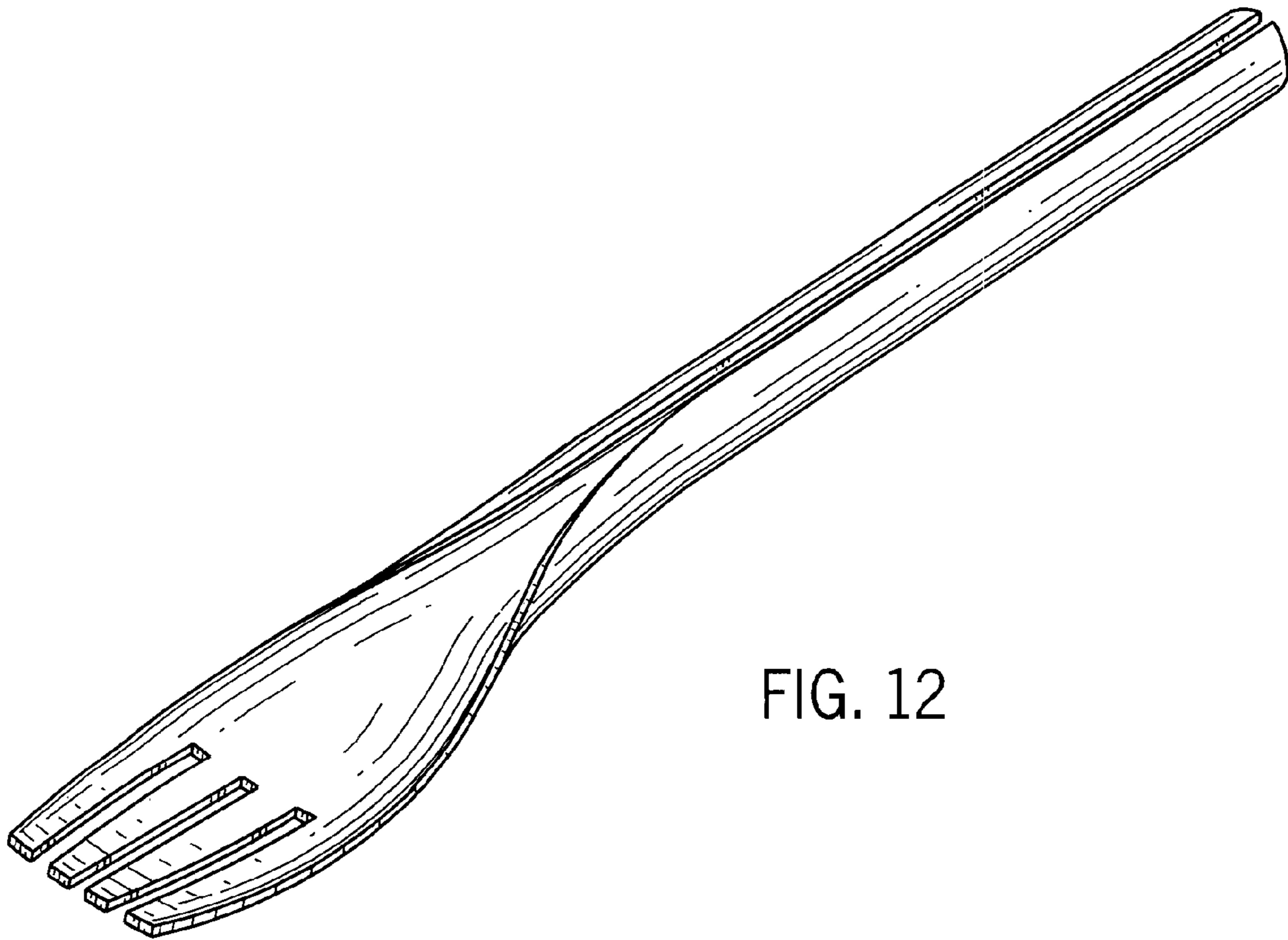

FIG. 12

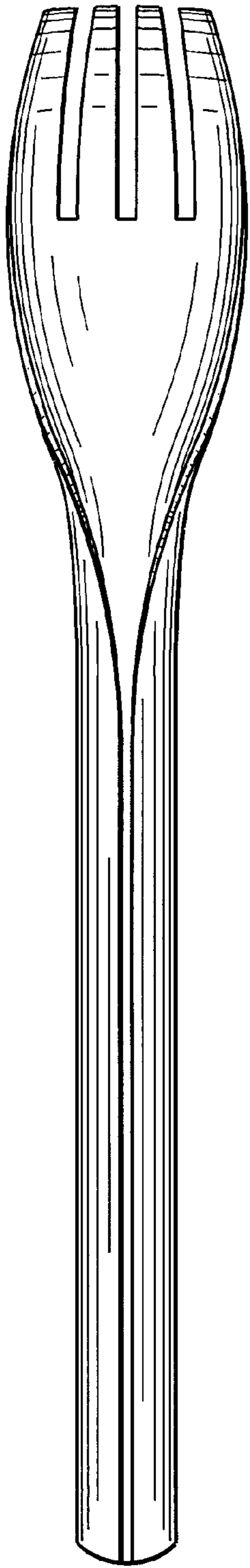

FIG. 13

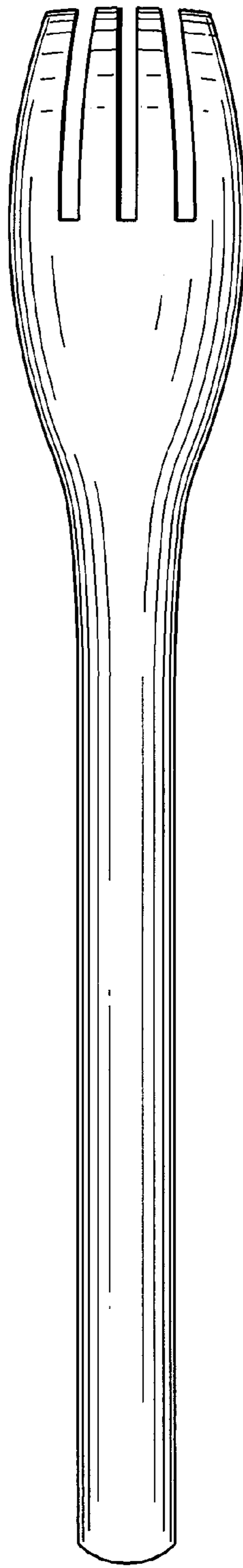

FIG. 14

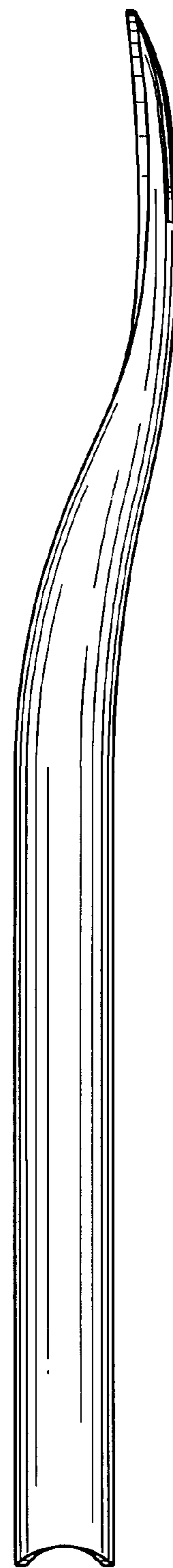

FIG. 15

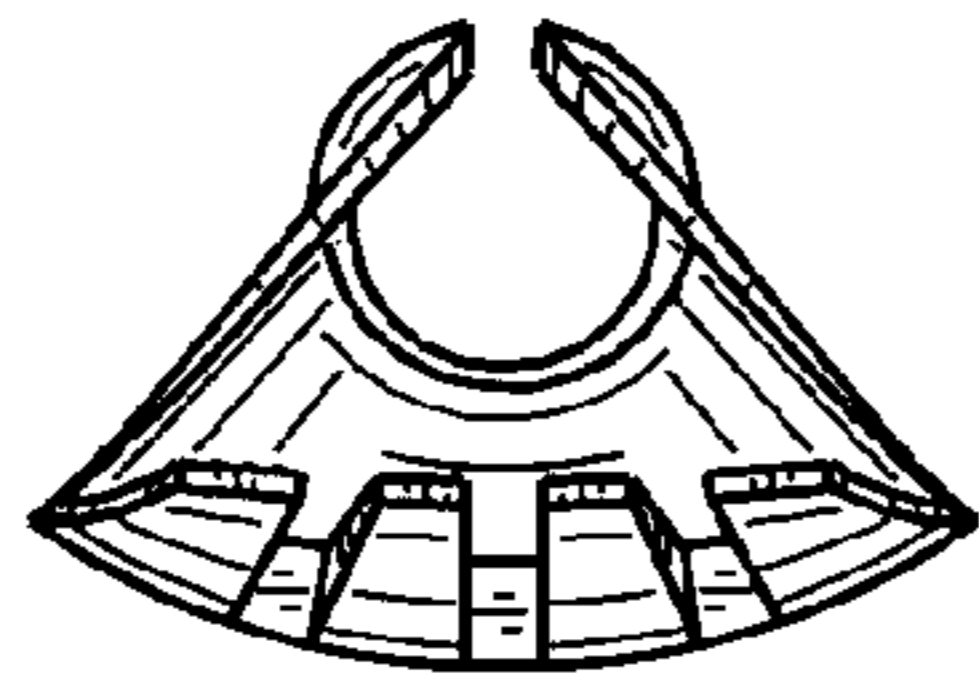

FIG. 16

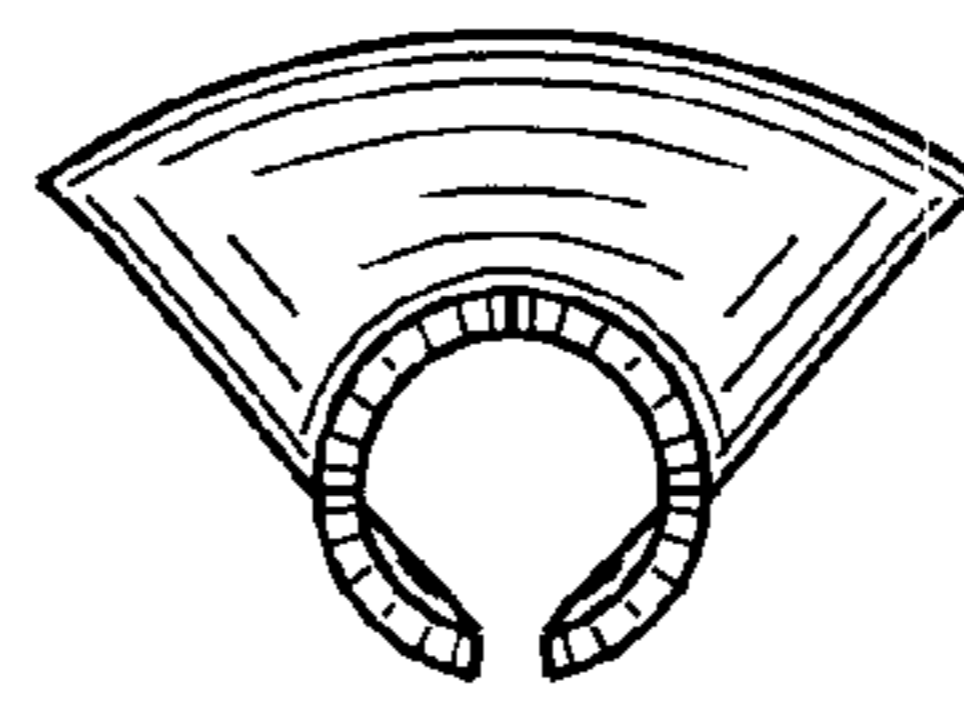

FIG. 17

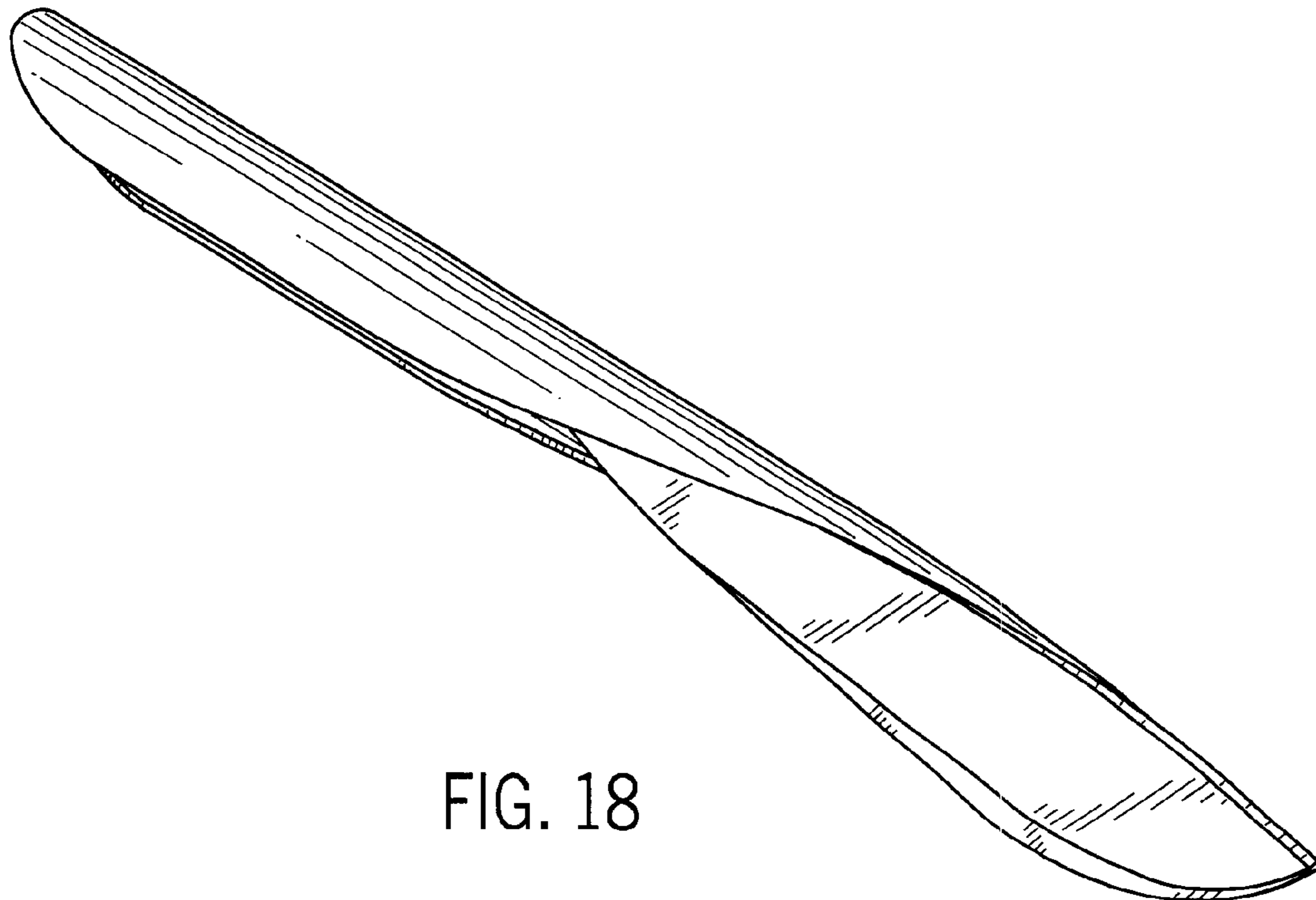

FIG. 18



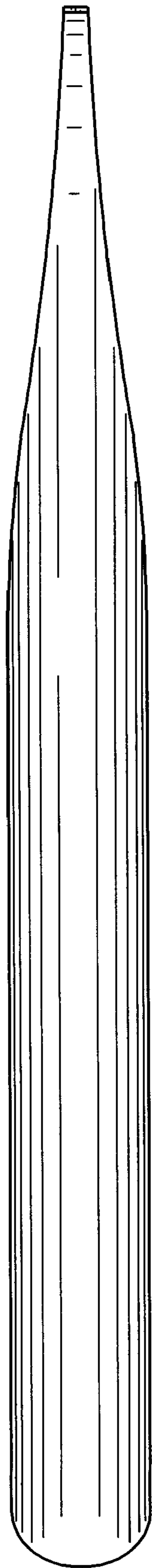

FIG. 19

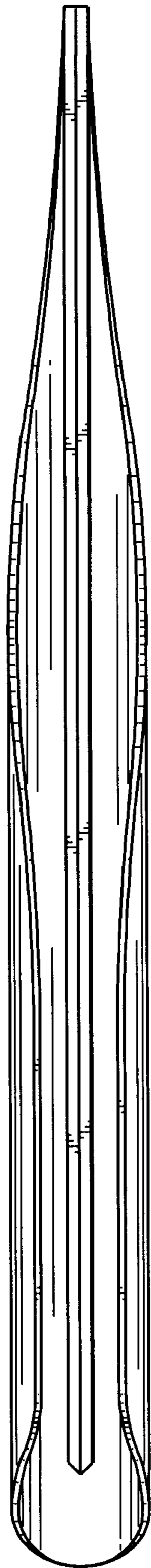

FIG. 20

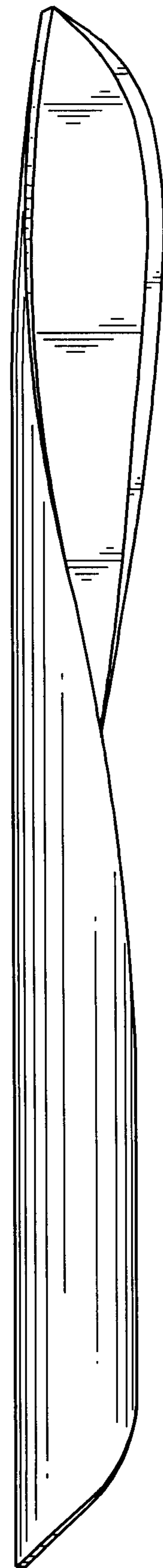

FIG. 21