



US00D530981S

(12) **United States Design Patent** (10) **Patent No.:** **US D530,981 S**  
**Bin** (45) **Date of Patent:** **\*\* Oct. 31, 2006**

(54) **MUG**  
(76) **Inventor:** **Jin Xue Bin**, Flat F, 5/F, Hop Hing Industrial Building, 704 Castle Peak Road, Cheung Sha Wan, Kowloon (HK)  
(\*\*) **Term:** **14 Years**  
(21) **Appl. No.:** **29/219,348**  
(22) **Filed:** **Dec. 15, 2004**

D467,124 S \* 12/2002 Janky ..... D7/533  
D472,425 S \* 4/2003 Hurlbut et al. .... D7/510  
D479,096 S \* 9/2003 Webb ..... D7/531  
D480,918 S \* 10/2003 Belton et al. .... D7/533  
D486,997 S \* 2/2004 Janky ..... D7/531  
D493,068 S \* 7/2004 Slater et al. .... D7/510  
D494,011 S \* 8/2004 Janky et al. .... D7/533  
D497,080 S \* 10/2004 Greenspon ..... D7/510  
D502,057 S \* 2/2005 Norris et al. .... D7/532  
D507,152 S \* 7/2005 Trombly ..... D7/536  
D511,653 S \* 11/2005 Oas ..... D7/507  
D512,269 S \* 12/2005 Trombly ..... D7/510

(30) **Foreign Application Priority Data**

Jul. 14, 2004 (HK) ..... 0411538

(51) **LOC (8) Cl.** ..... **07-01**  
(52) **U.S. Cl.** ..... **D7/510; D7/511; D7/536**  
(58) **Field of Classification Search** ..... D7/509, D7/510, 511, 529, 532, 523, 536, 533; D9/552, D9/553, 502, 503, 565, 551, 564, 443, 504, D9/500; 220/574, 575, 4.26, 606, 605, 23.89, 220/674, 703, 713, 719, 592.16, 592.17; 215/383, 387, 395, 388, 12.1; 229/400; D34/1; 206/217

See application file for complete search history.

(56) **References Cited**

**U.S. PATENT DOCUMENTS**

5,531,353 A \* 7/1996 Ward et al. .... 220/729  
D417,365 S \* 12/1999 Huang ..... D7/511  
D427,853 S \* 7/2000 Kohlhase ..... D7/510  
D428,306 S \* 7/2000 Lee ..... D7/510  
D433,877 S \* 11/2000 Bickert et al. .... D7/536

\* cited by examiner

*Primary Examiner*—M. N. Pandozzi

(74) *Attorney, Agent, or Firm*—Law Office of Sergei Orel, LLC

(57) **CLAIM**

The ornamental design for a mug, as shown and described.

**DESCRIPTION**

FIG. 1 is a front elevational view of a mug showing my new design;  
FIG. 2 is a rear elevational view thereof;  
FIG. 3 is a left side elevational view thereof;  
FIG. 4 is a top plan view thereof;  
FIG. 5 is a bottom plan view thereof;  
FIG. 6 is a right side elevational view thereof;  
FIG. 7 is a top perspective view thereof; and,  
FIG. 8 is an exploded perspective view thereof.

**1 Claim, 5 Drawing Sheets**

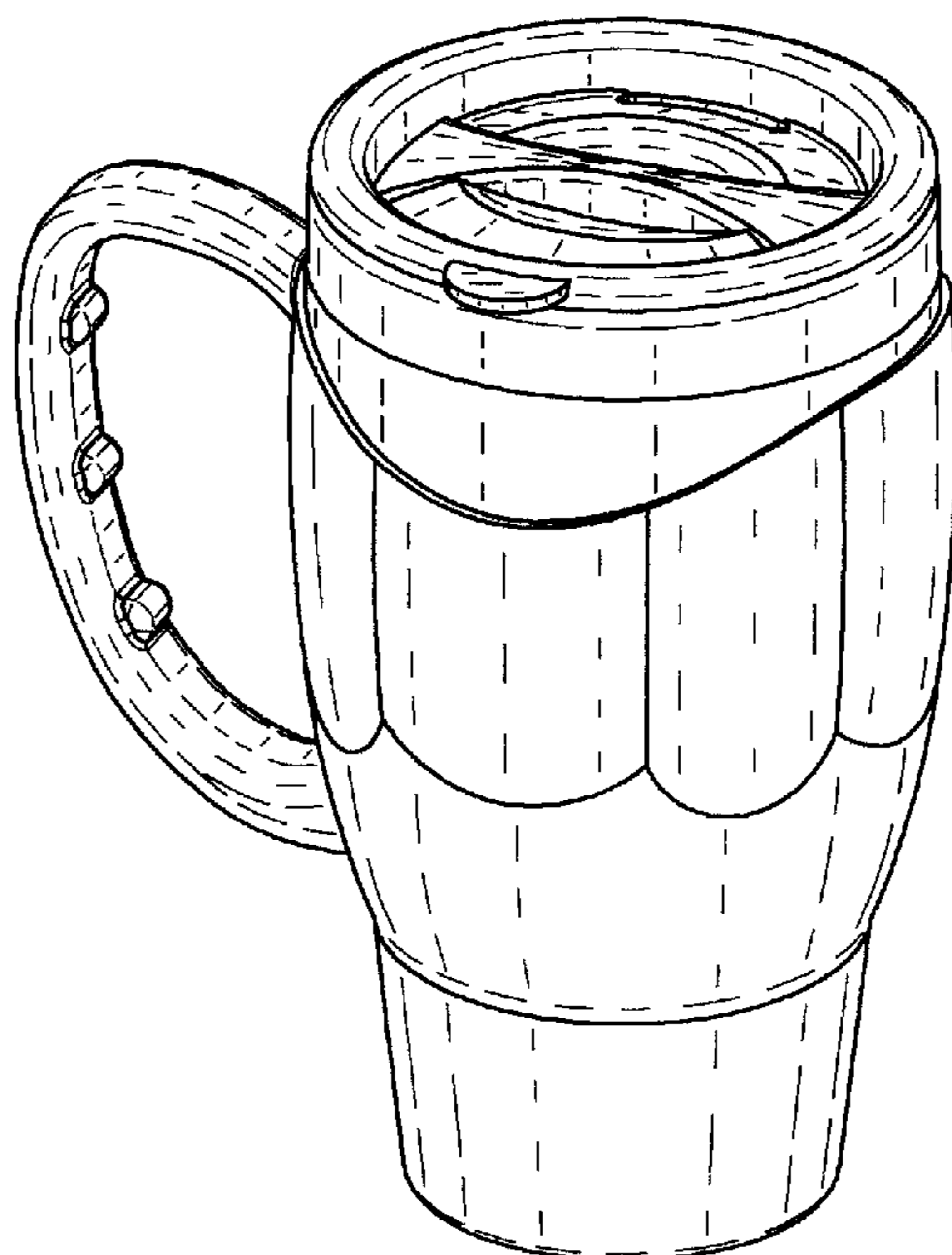

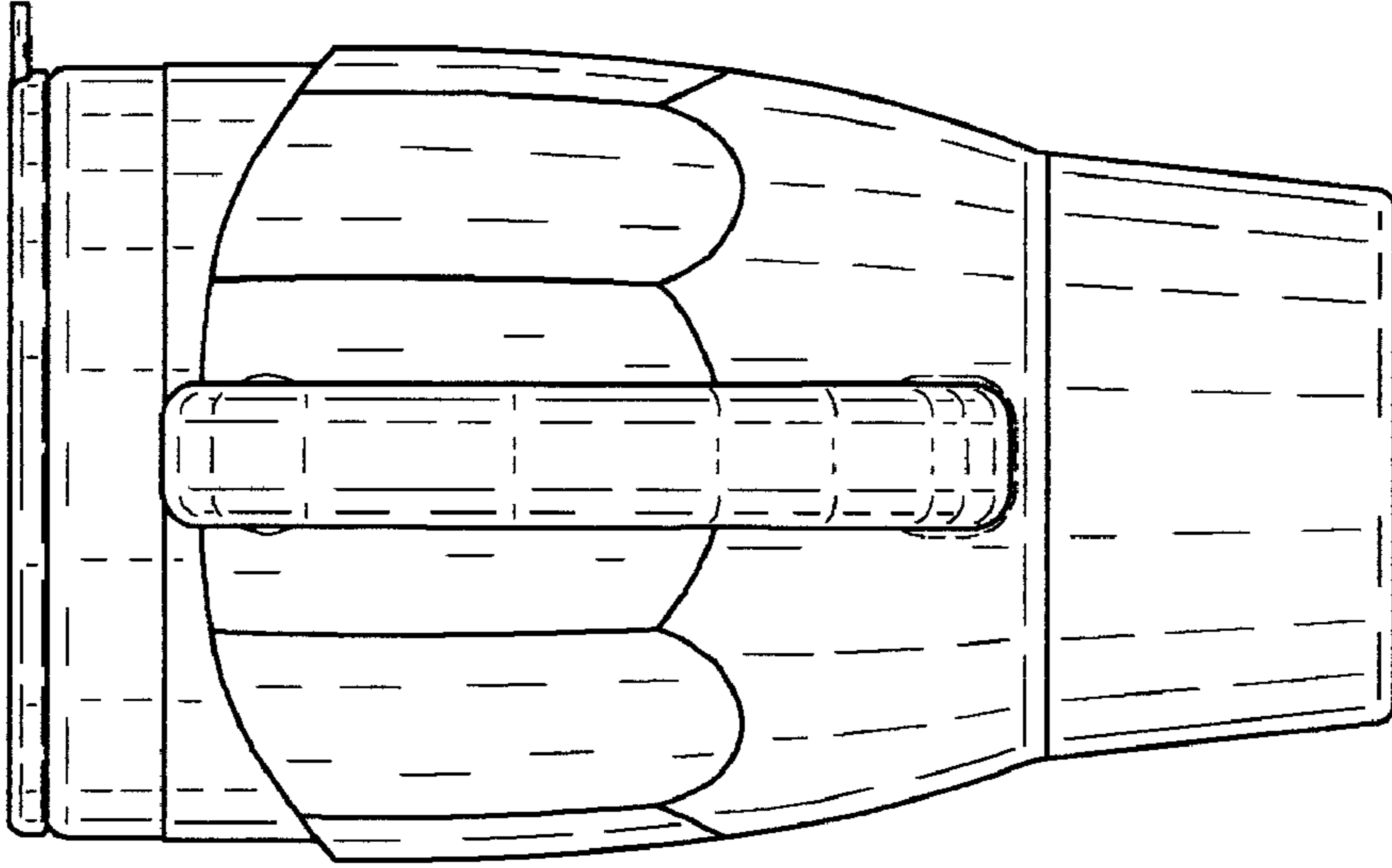

Fig. 2

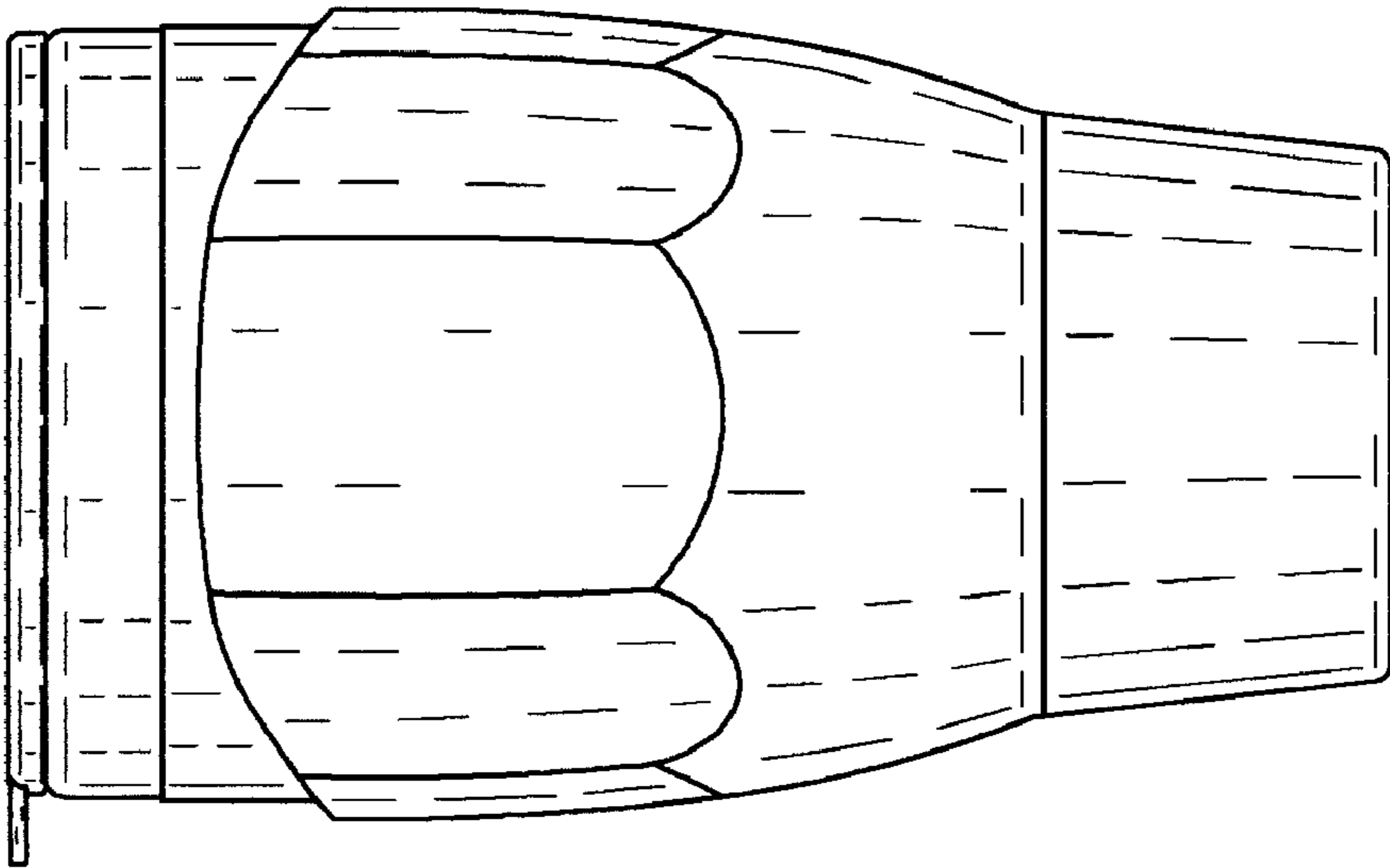

Fig. 1

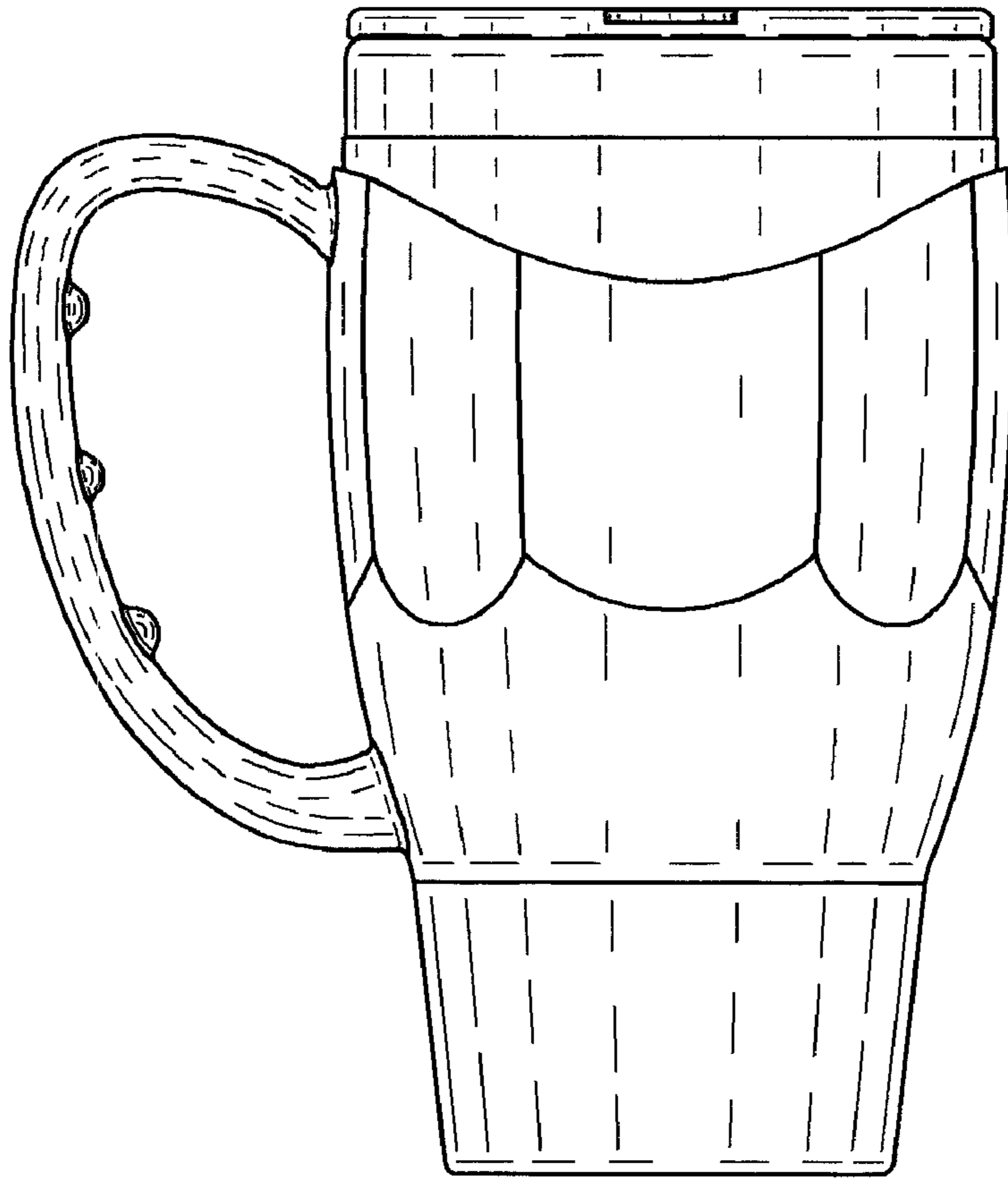

Fig.3

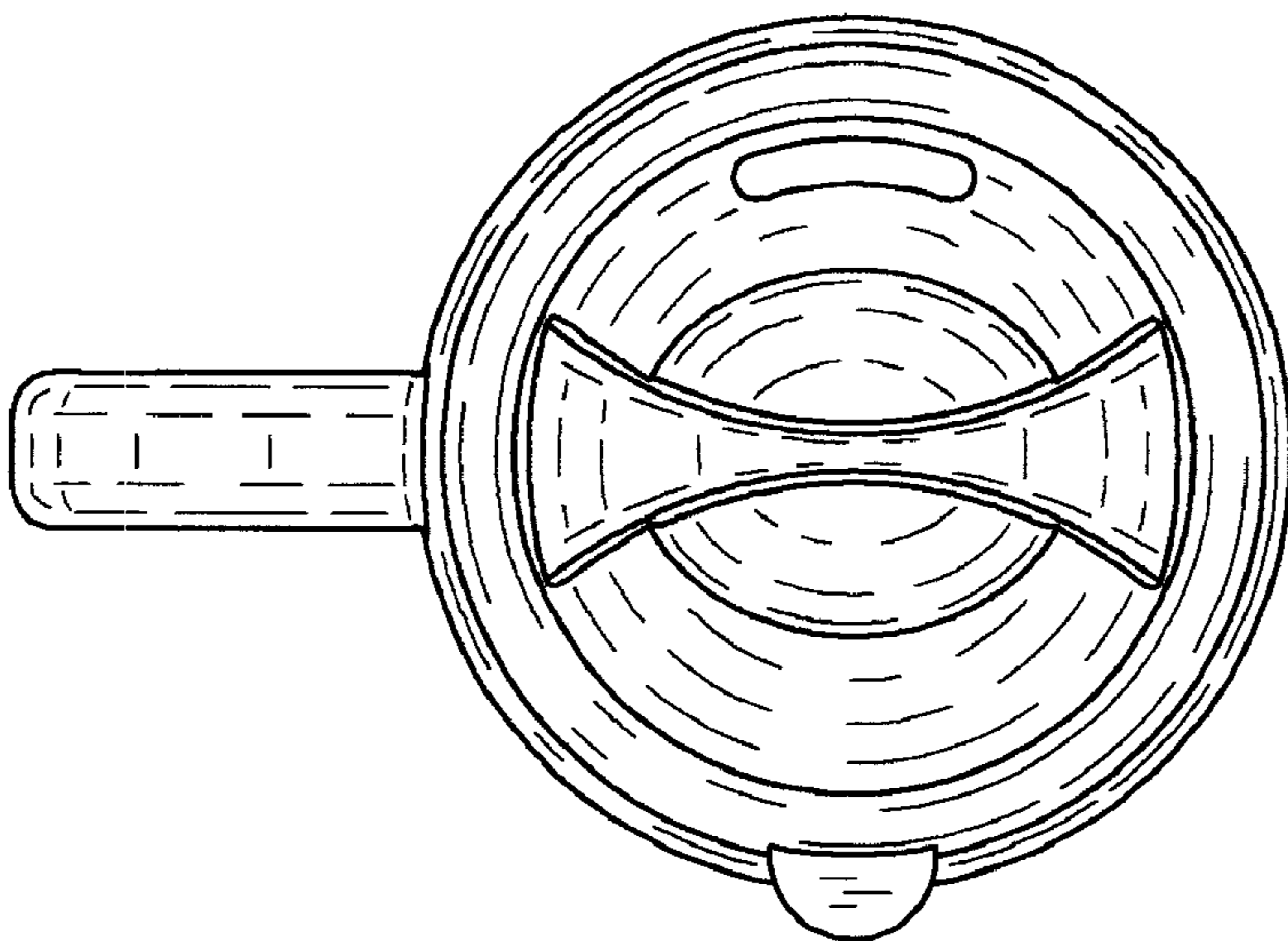

Fig.4

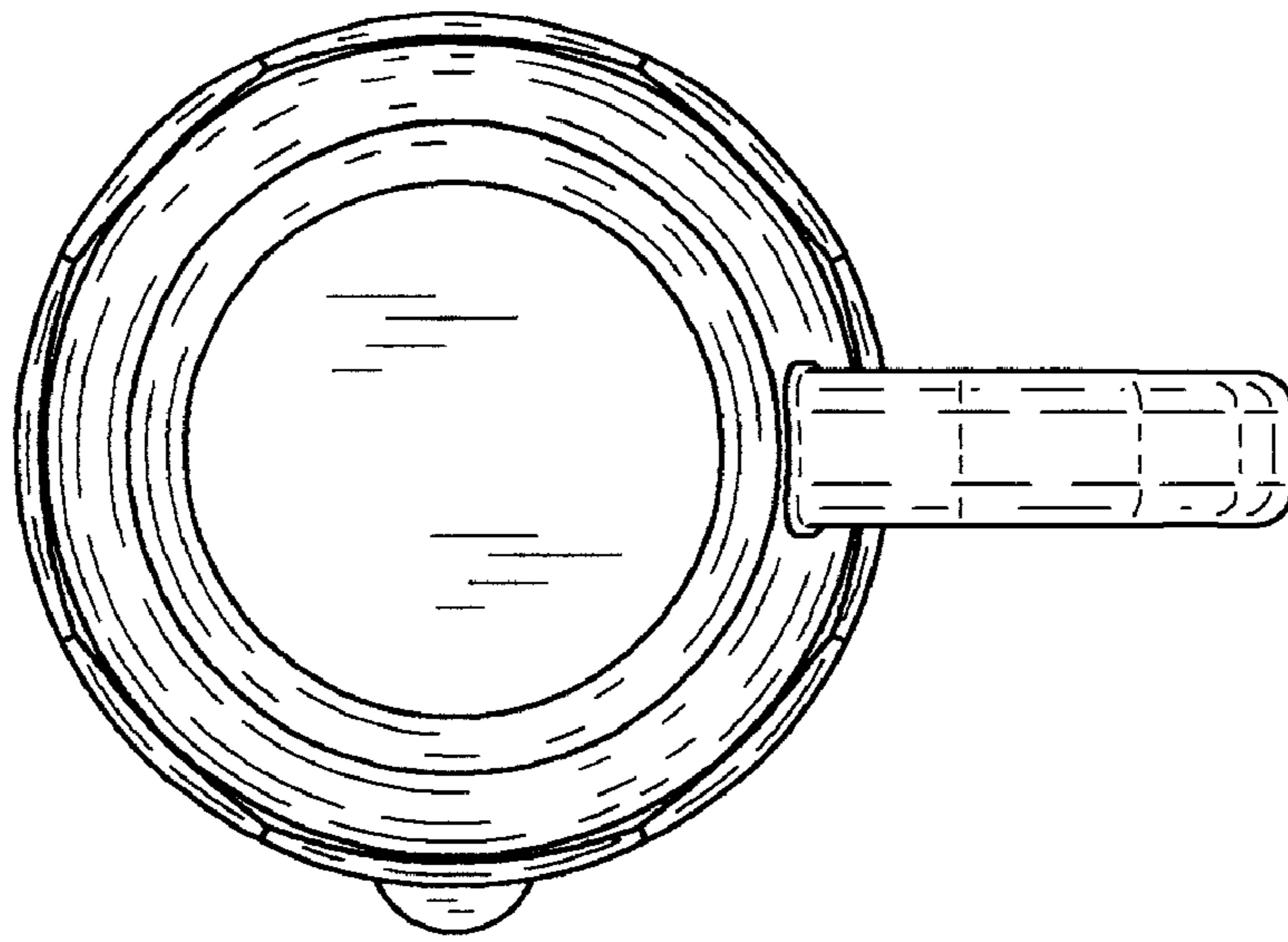

Fig.5

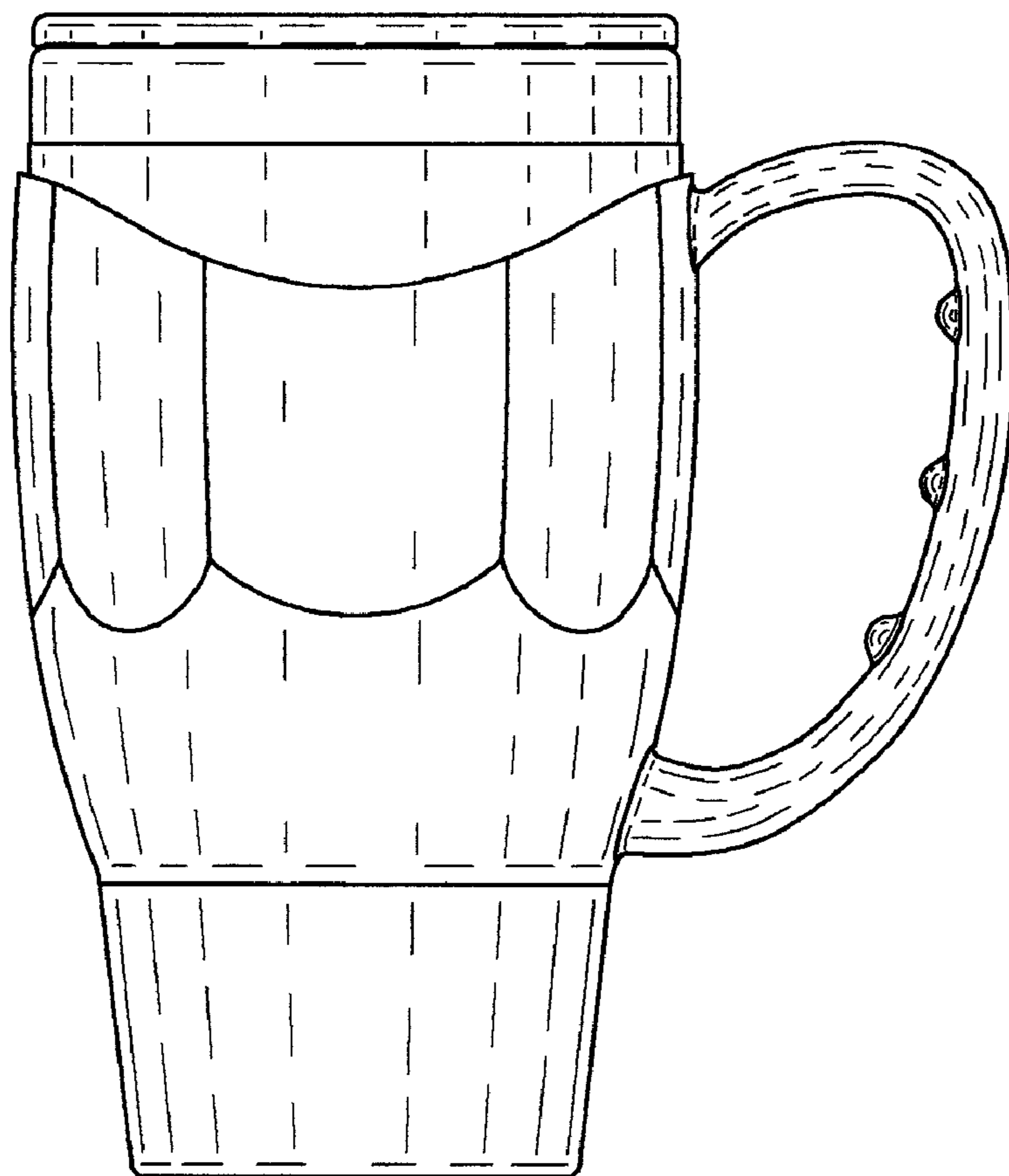

Fig.6

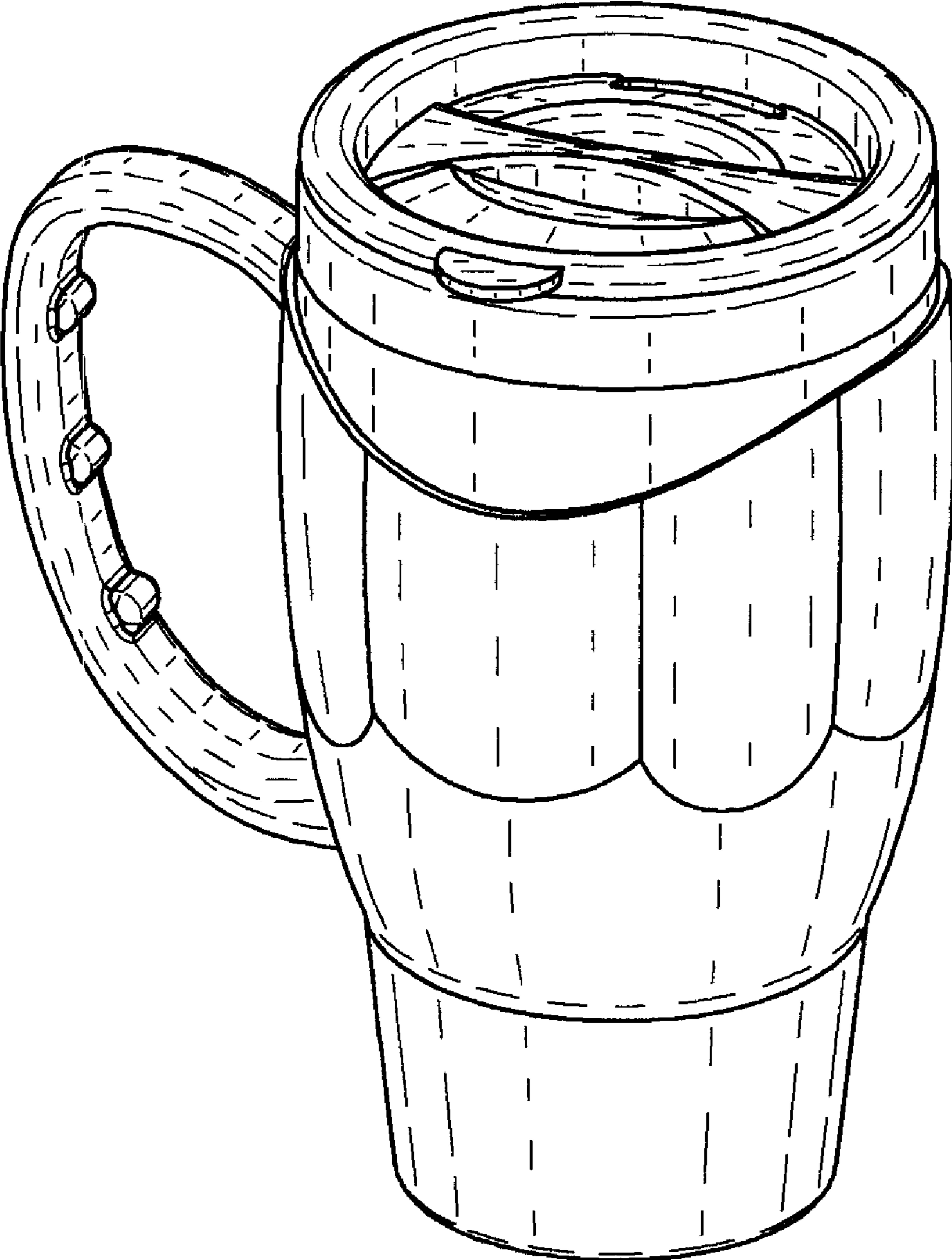

Fig.7

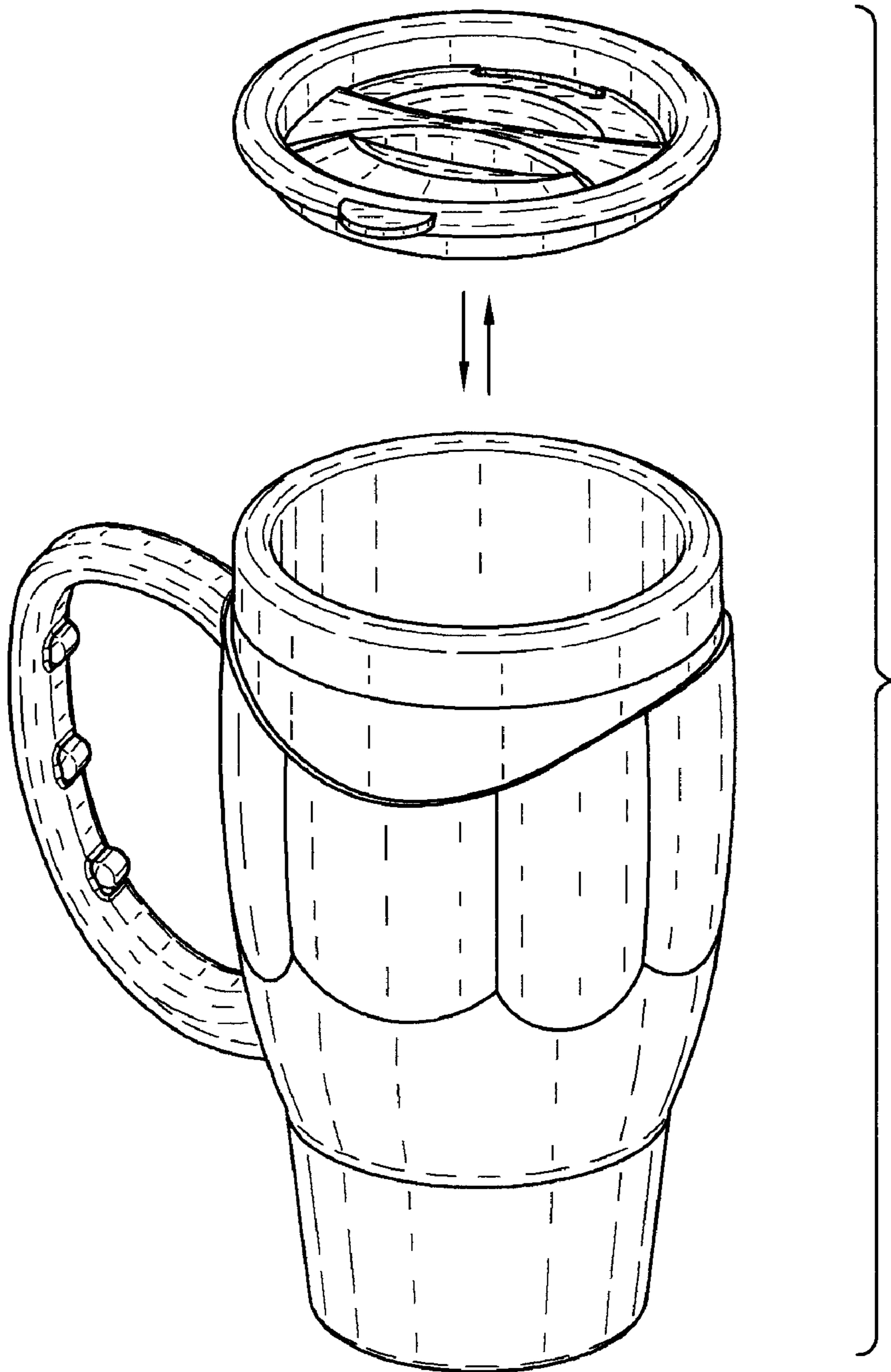

Fig.8