



US00D530930S

(12) **United States Design Patent**  
**Foy**

(10) **Patent No.:** **US D530,930 S**  
(45) **Date of Patent:** **\*\* Oct. 31, 2006**

(54) **STOOL**

(75) Inventor: **Hunter Thornell Foy**, 39 SW. 10<sup>th</sup>  
Ave., Boca Raton, FL (US) 33486

(73) Assignee: **Hunter Thornell Foy**, Boca Raton, FL  
(US)

(\*\*) Term: **14 Years**

(21) Appl. No.: **29/239,346**

(22) Filed: **Sep. 29, 2005**

(51) **LOC (8) Cl.** ..... **06-01**

(52) **U.S. Cl.** ..... **D6/349; D6/485**

(58) **Field of Classification Search** ..... D6/332,  
D6/335-337, 340, 349, 355, 352-353, 369-370,  
D6/381, 495, 499-502, 480, 484, 485; 5/12.1;  
108/118, 119, 137; 297/16.1-16.2, 451.9,  
297/452.11, 452.63, 217.1, 31, 175, 423.1,  
297/423.16, 461, 232

See application file for complete search history.

(56) **References Cited**

**U.S. PATENT DOCUMENTS**

- D161,217 S \* 12/1950 Silverman ..... D6/485
- D200,413 S \* 2/1965 Pearsall ..... D6/495
- D239,678 S \* 4/1976 Blake ..... D6/466

- D240,871 S \* 8/1976 Herman ..... D6/352
- 4,109,588 A \* 8/1978 Powers ..... 108/12
- D254,994 S \* 5/1980 Mioreanu et al. .... D30/106
- D286,345 S \* 10/1986 Stanislawski et al. .... D6/349
- D418,696 S \* 1/2000 Tomar ..... D6/484
- D424,123 S \* 5/2000 Henriksen ..... D21/671
- D456,644 S \* 5/2002 Weaver ..... D6/484
- D480,885 S \* 10/2003 Martin ..... D6/349

\* cited by examiner

*Primary Examiner*—Sandra S. Snapp

(57) **CLAIM**

The ornamental design for a stool, as shown and described.

**DESCRIPTION**

FIG. 1 is a top left perspective view of the stool showing the new design;  
 FIG. 2 is a front elevational view thereof on a reduced scale;  
 FIG. 3 is a right side elevational view thereof on a reduced scale;  
 FIG. 4 is a rear elevational view thereof on a reduced scale;  
 FIG. 5 is a left side elevational view thereof on a reduced scale;  
 FIG. 6 is a top plan view thereof on a reduced scale; and,  
 FIG. 7 is a bottom plan view thereof on a reduced scale.

**1 Claim, 7 Drawing Sheets**

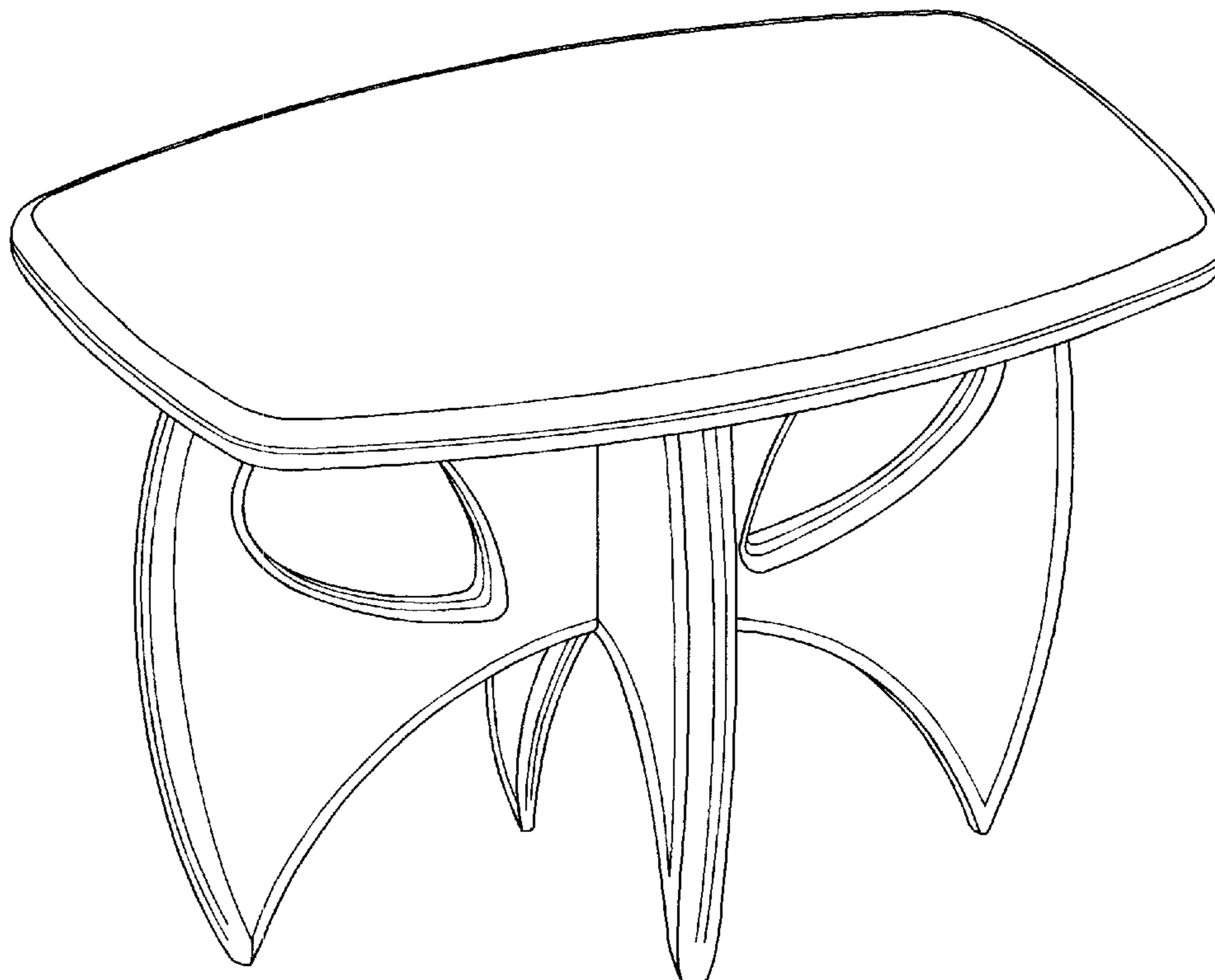

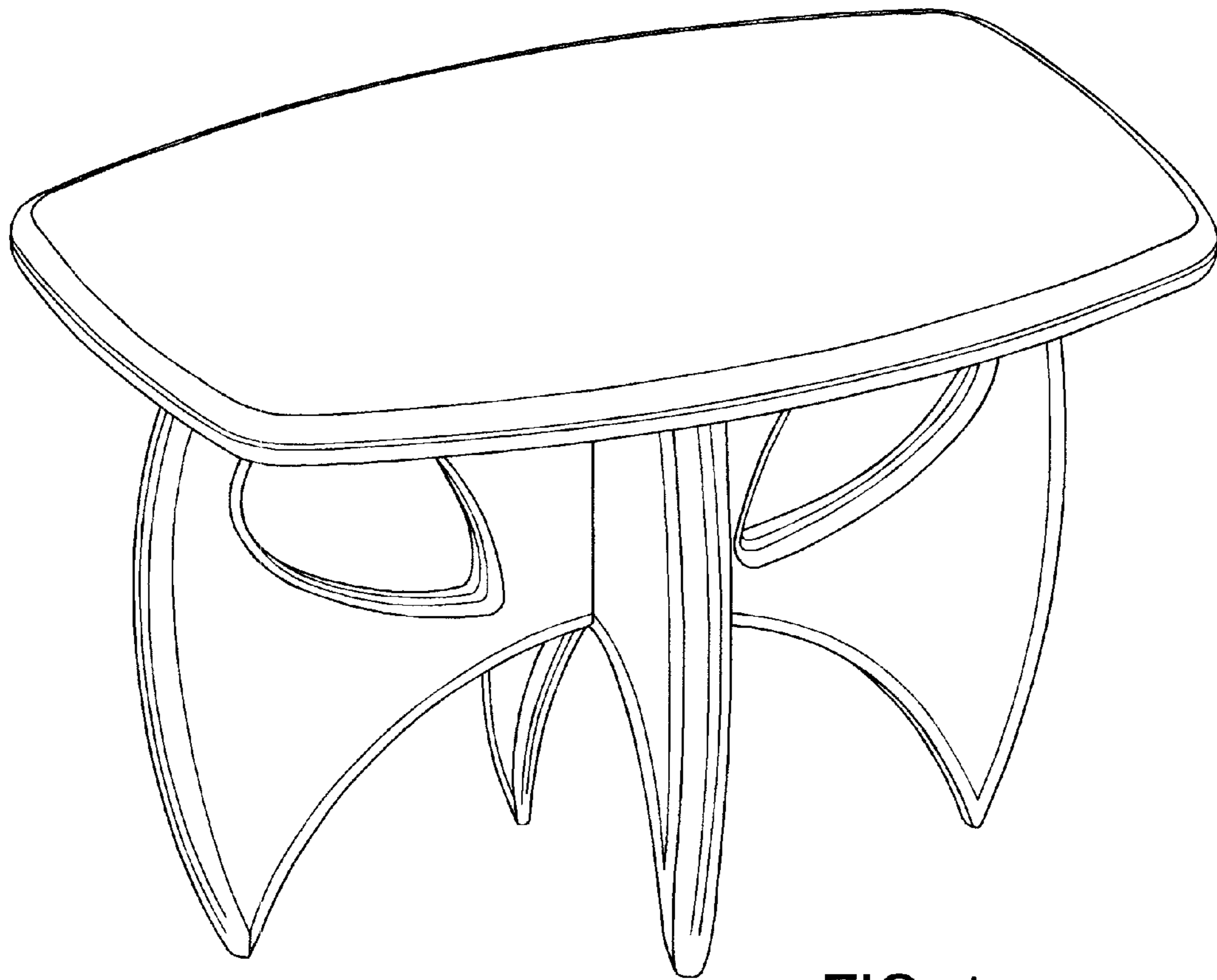

FIG. 1

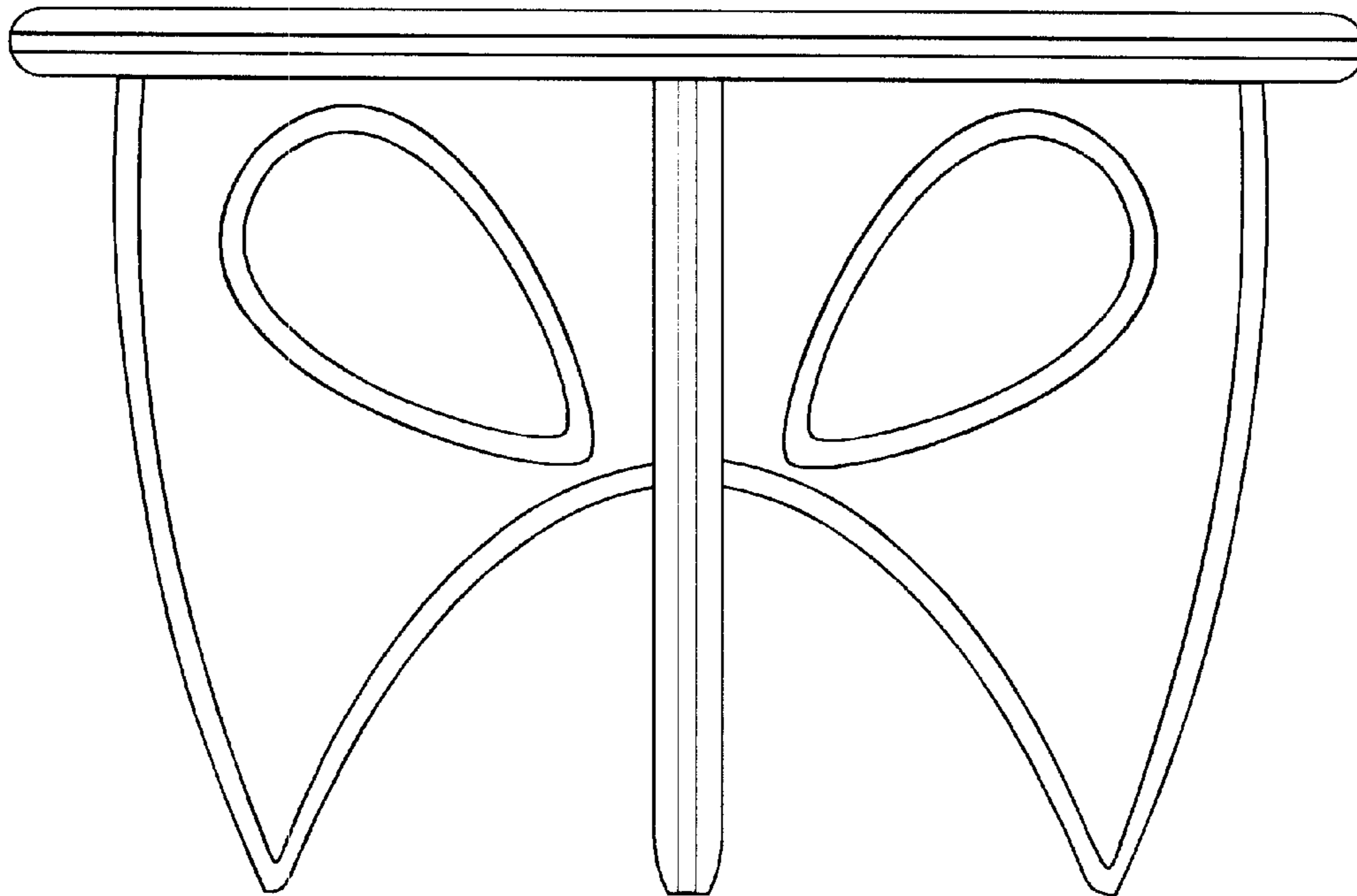

FIG. 2

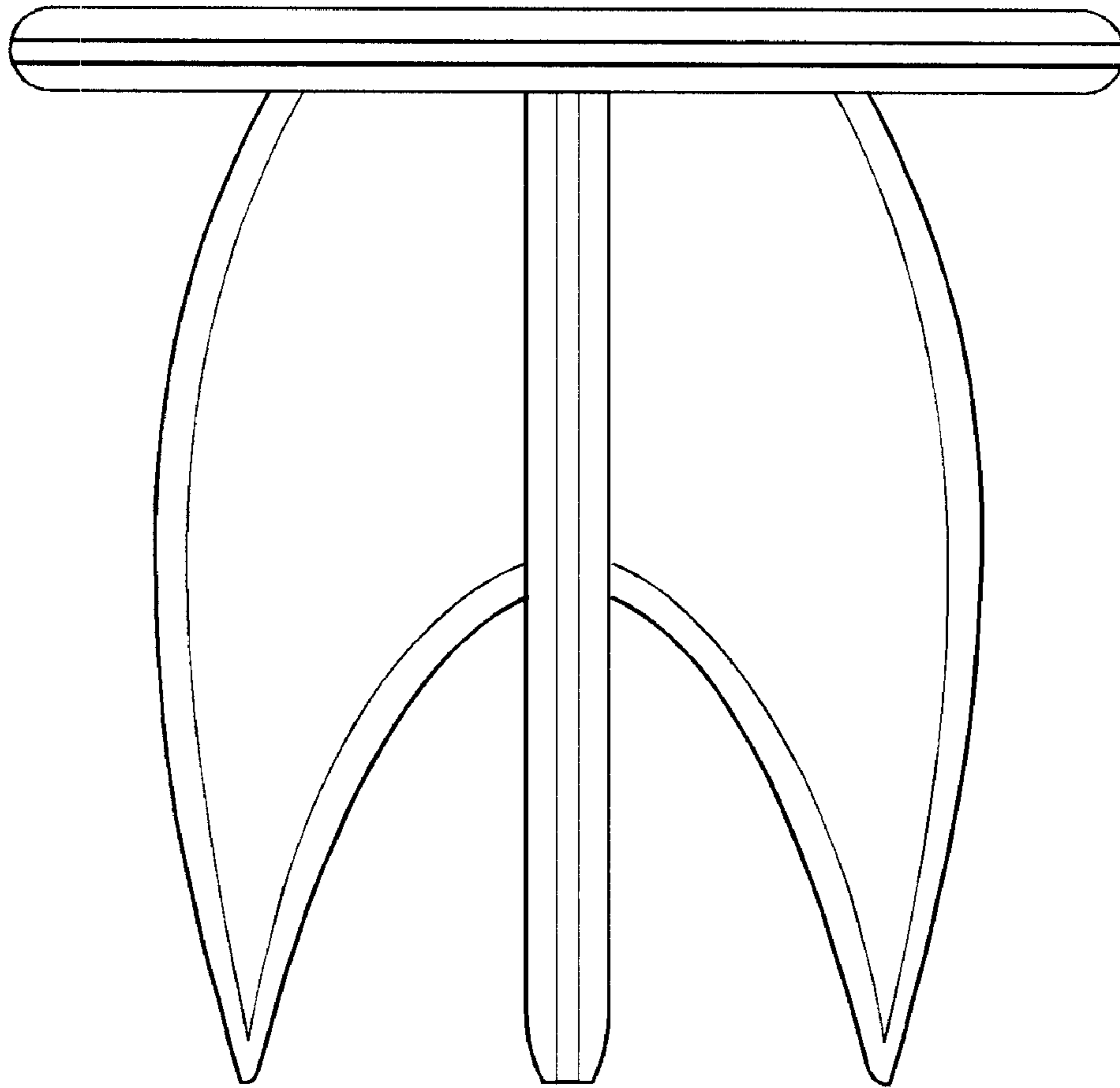

FIG. 3

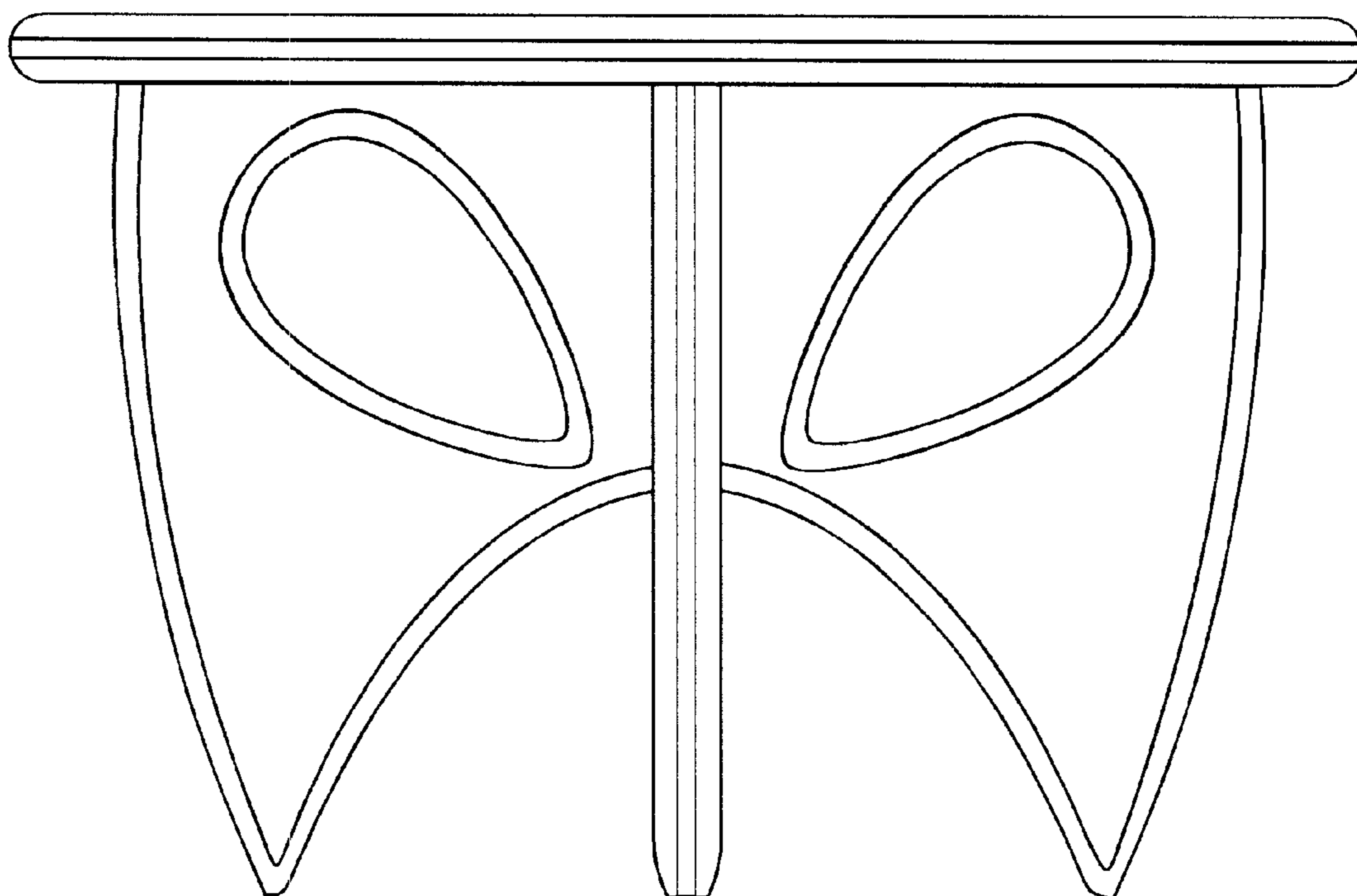

FIG. 4

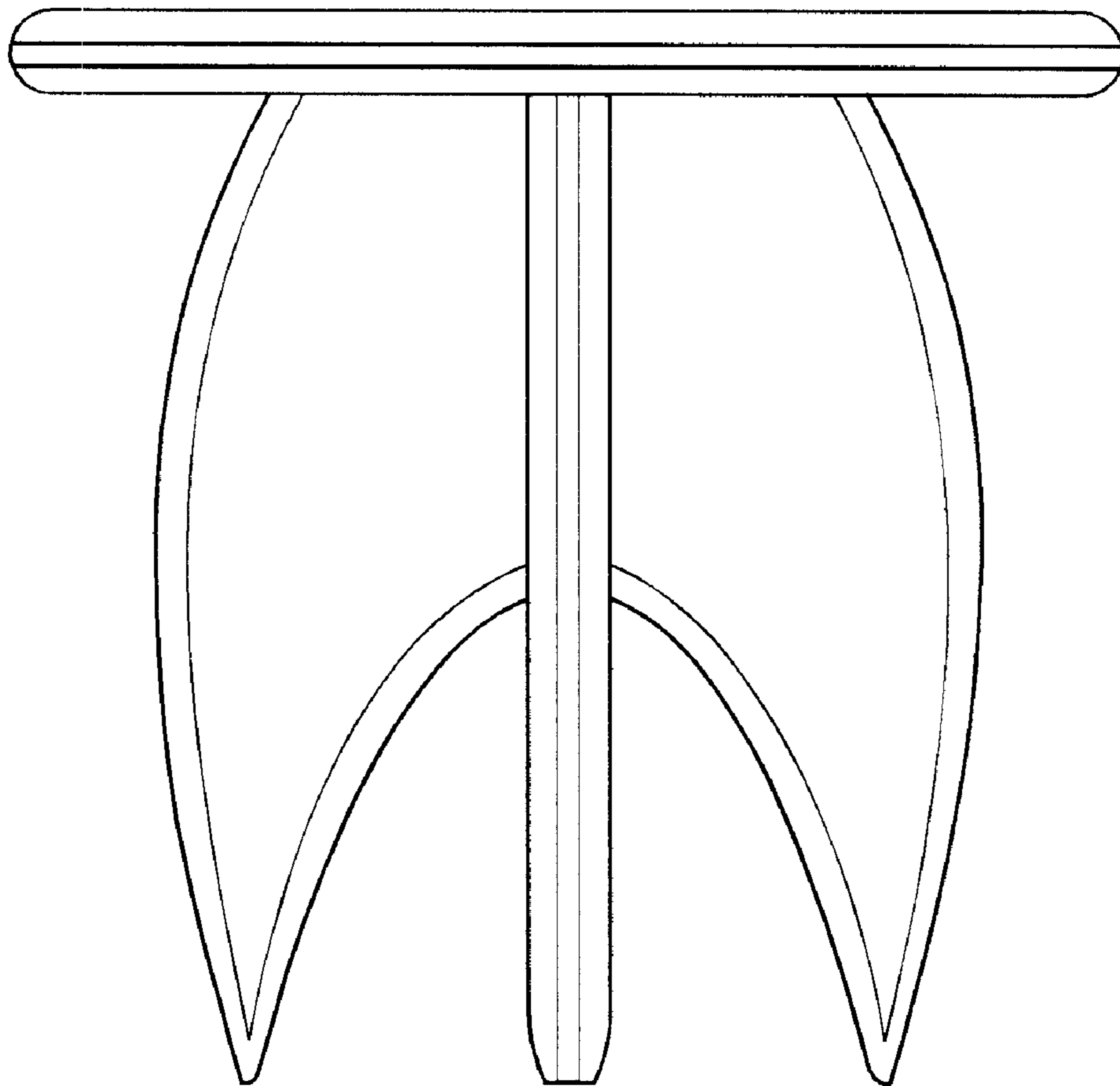

FIG. 5

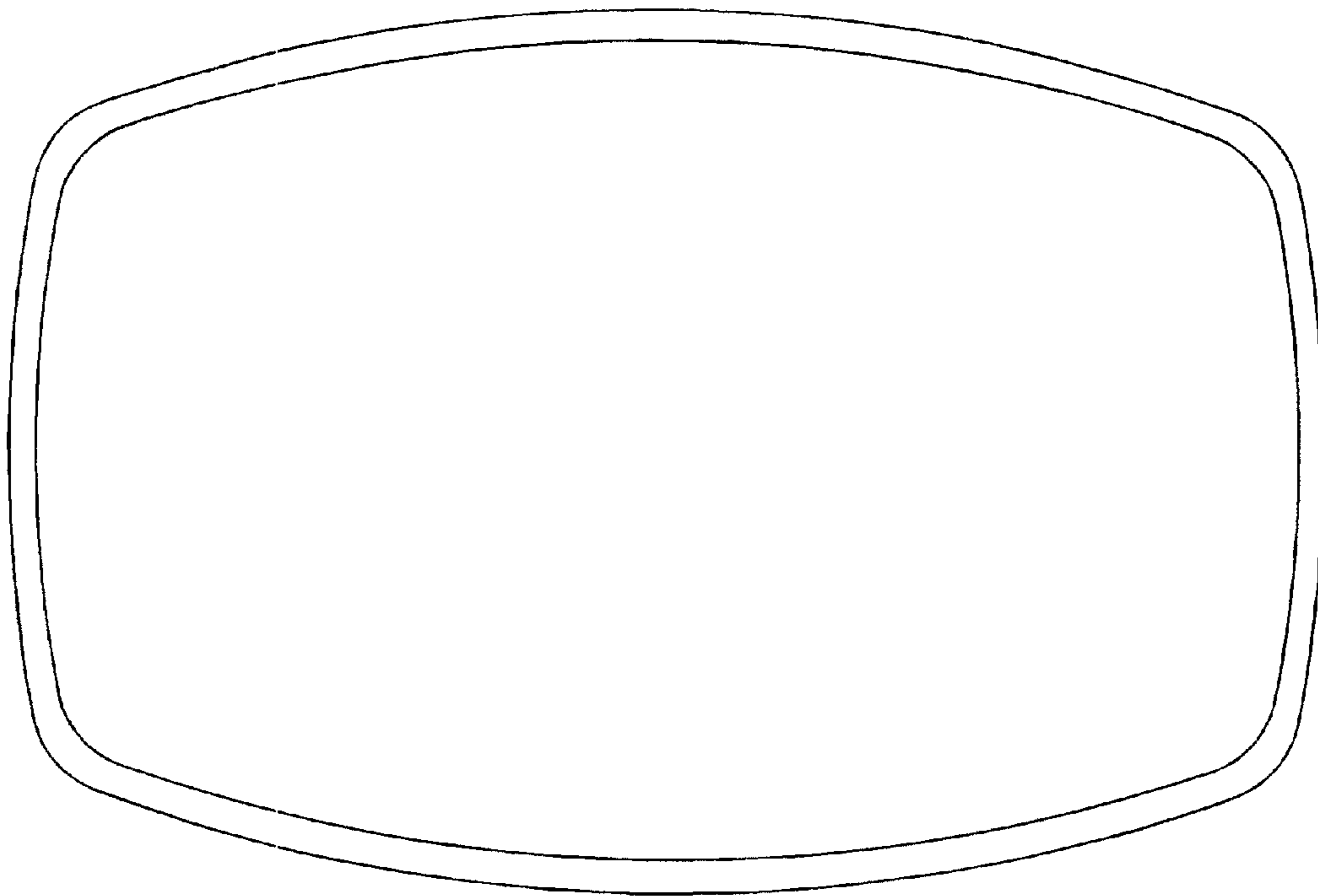

FIG. 6

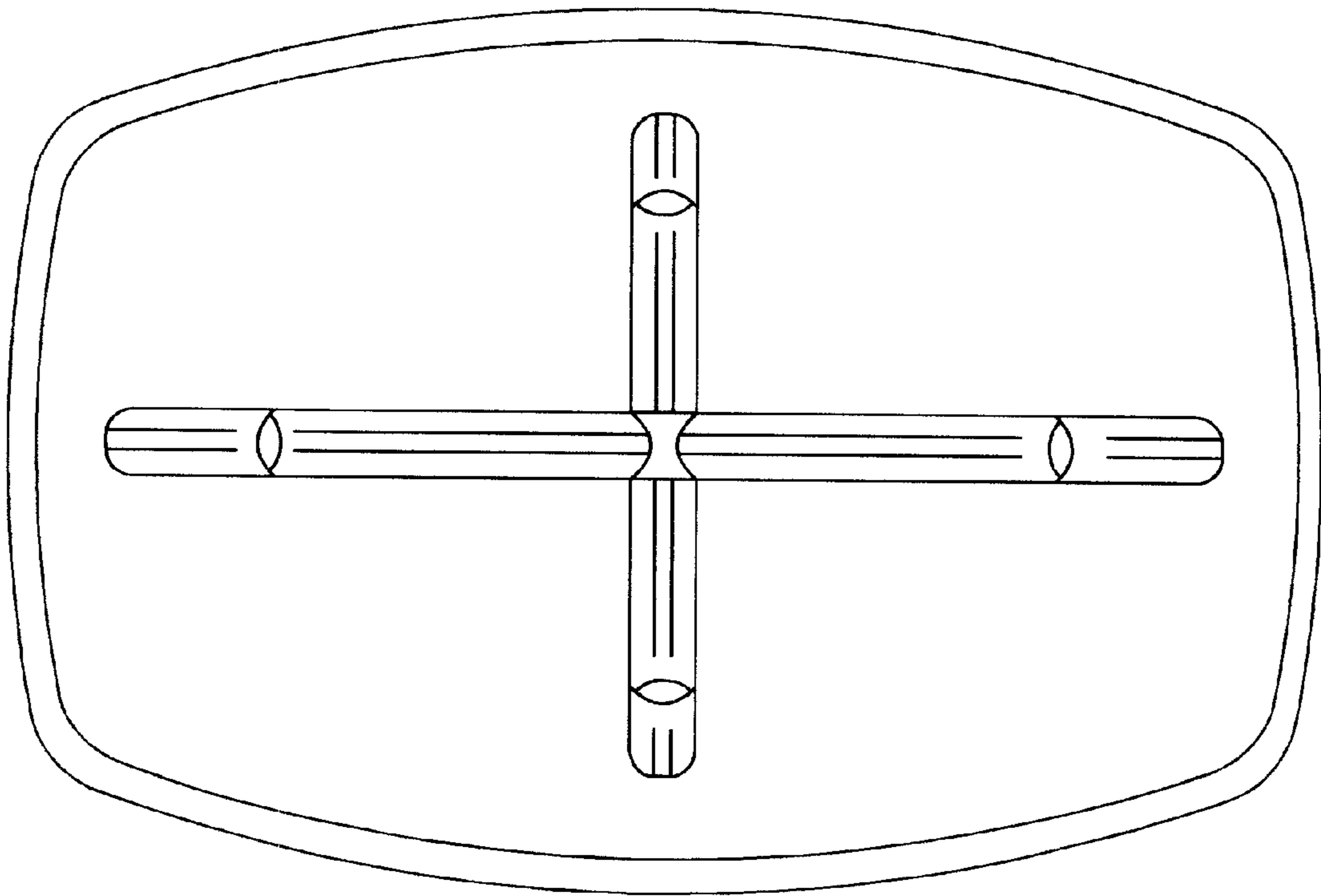

FIG. 7