



US00D530874S

(12) **United States Design Patent**
Lin

(10) **Patent No.:** **US D530,874 S**

(45) **Date of Patent:** **** Oct. 24, 2006**

(54) **GARBAGE CAN**

D518,266 S * 3/2006 Yang et al. D34/9
D520,208 S * 5/2006 Lin D34/9

(76) Inventor: **Tsong-Yow Lin**, No. 57-1, Yung Ho Street, Yung Ho Village, Ta Tu Hsiang, Taichung Hsien (TW)

* cited by examiner

(**) Term: **14 Years**

Primary Examiner—Cynthia E. Ramirez
(74) *Attorney, Agent, or Firm*—Alan D. Kamrath; Nikolai & Mersereau, P.A.

(21) Appl. No.: **29/217,807**

(57) **CLAIM**

(22) Filed: **Nov. 22, 2004**

The ornamental design for garbage can, as shown and described.

(51) **LOC (8) Cl.** **09-09**

(52) **U.S. Cl.** **D34/9**

(58) **Field of Classification Search** D34/1,
D34/5, 6, 7, 8, 9, 10, 11; 220/908–911, 262–264
See application file for complete search history.

DESCRIPTION

FIG. 1 is a perspective view of a garbage can showing my new design;
FIG. 2 is a front view thereof;
FIG. 3 is a rear view thereof;
FIG. 4 is a left view thereof;
FIG. 5 is a right view thereof;
FIG. 6 is a top view thereof; and,
FIG. 7 is a bottom view thereof.

(56) **References Cited**

U.S. PATENT DOCUMENTS

D480,193 S * 9/2003 Wang D34/9
D489,503 S * 5/2004 Lin D34/9
D503,502 S * 3/2005 Lai D34/9
D517,766 S * 3/2006 Lin D34/9

1 Claim, 3 Drawing Sheets

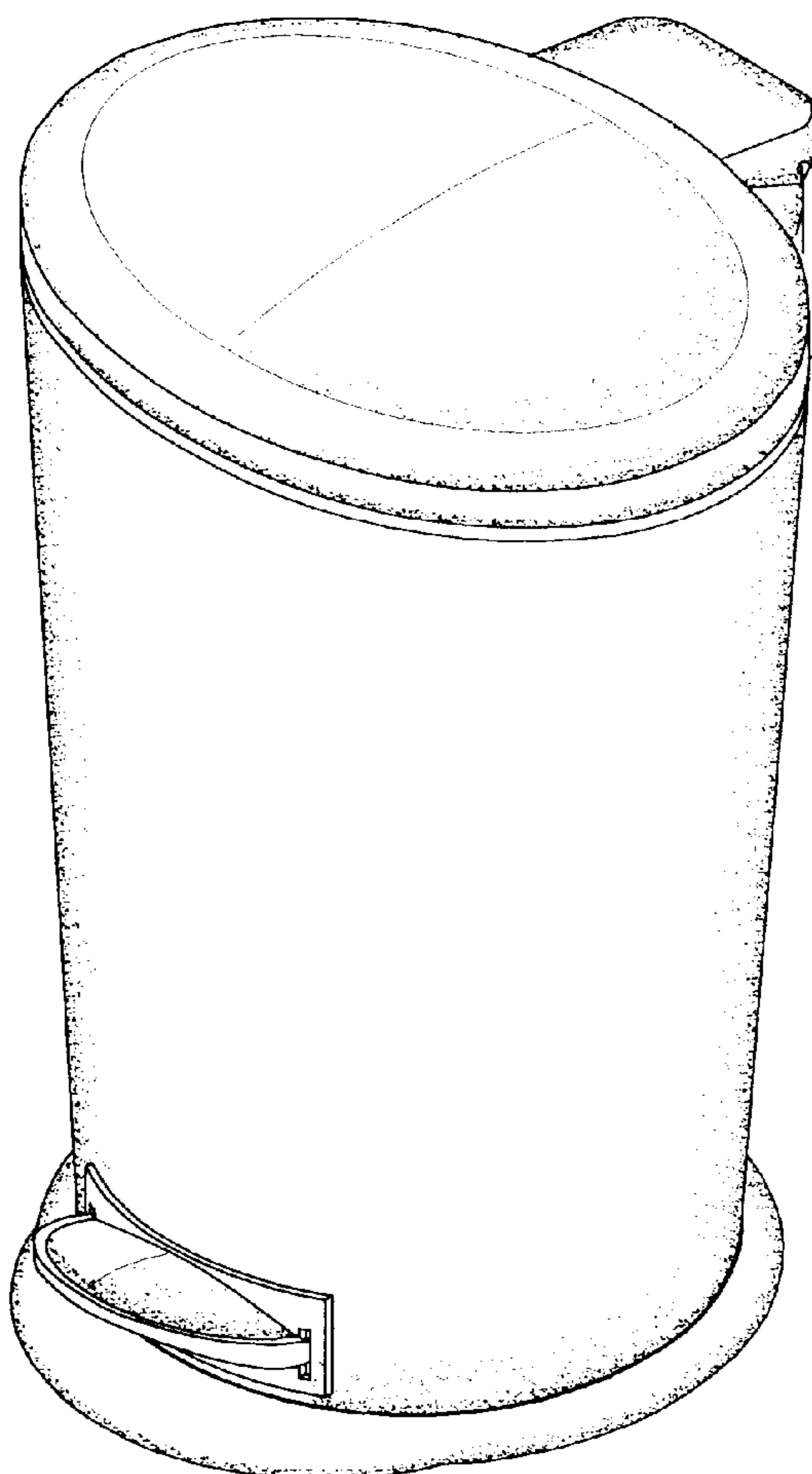

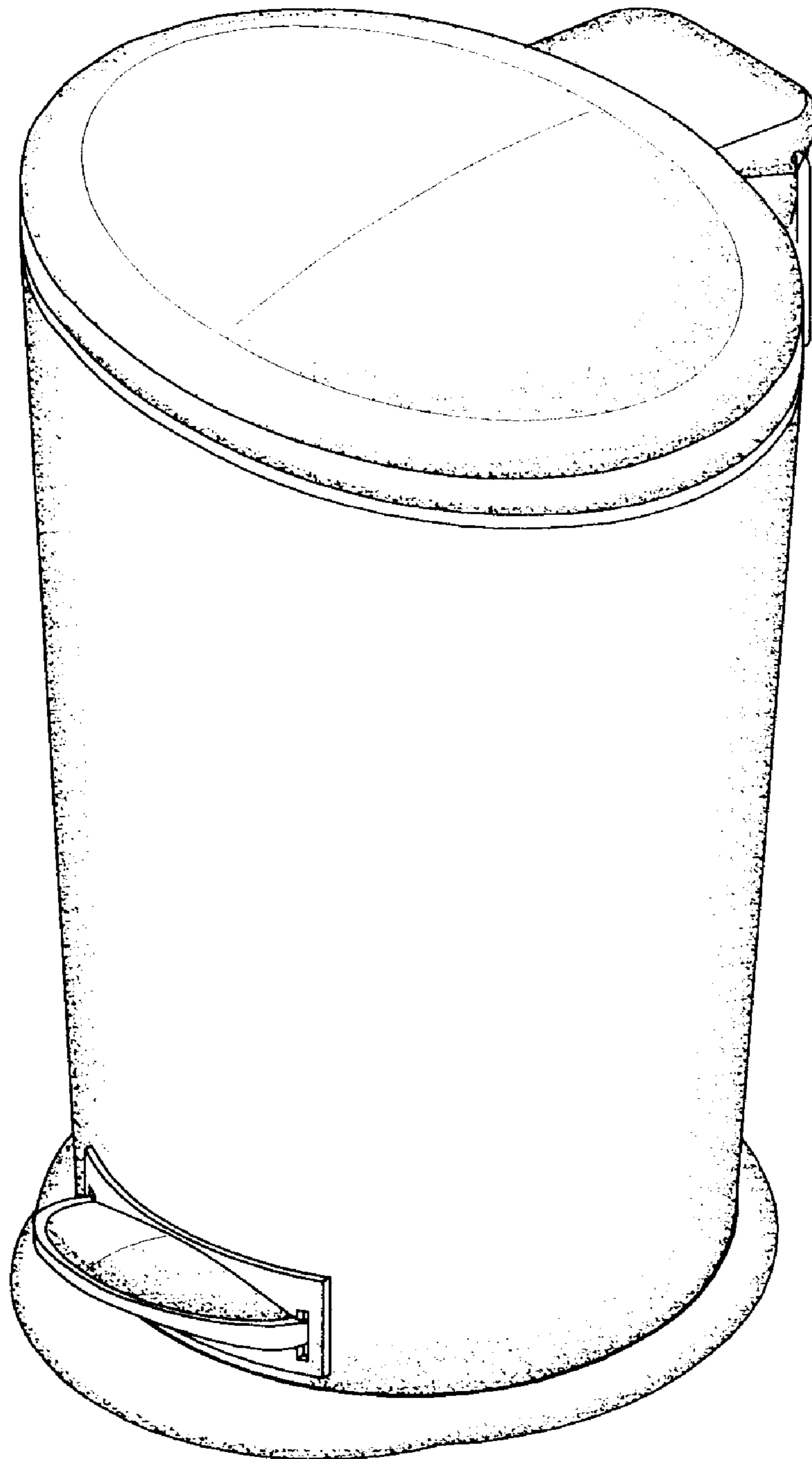

Fig. 1

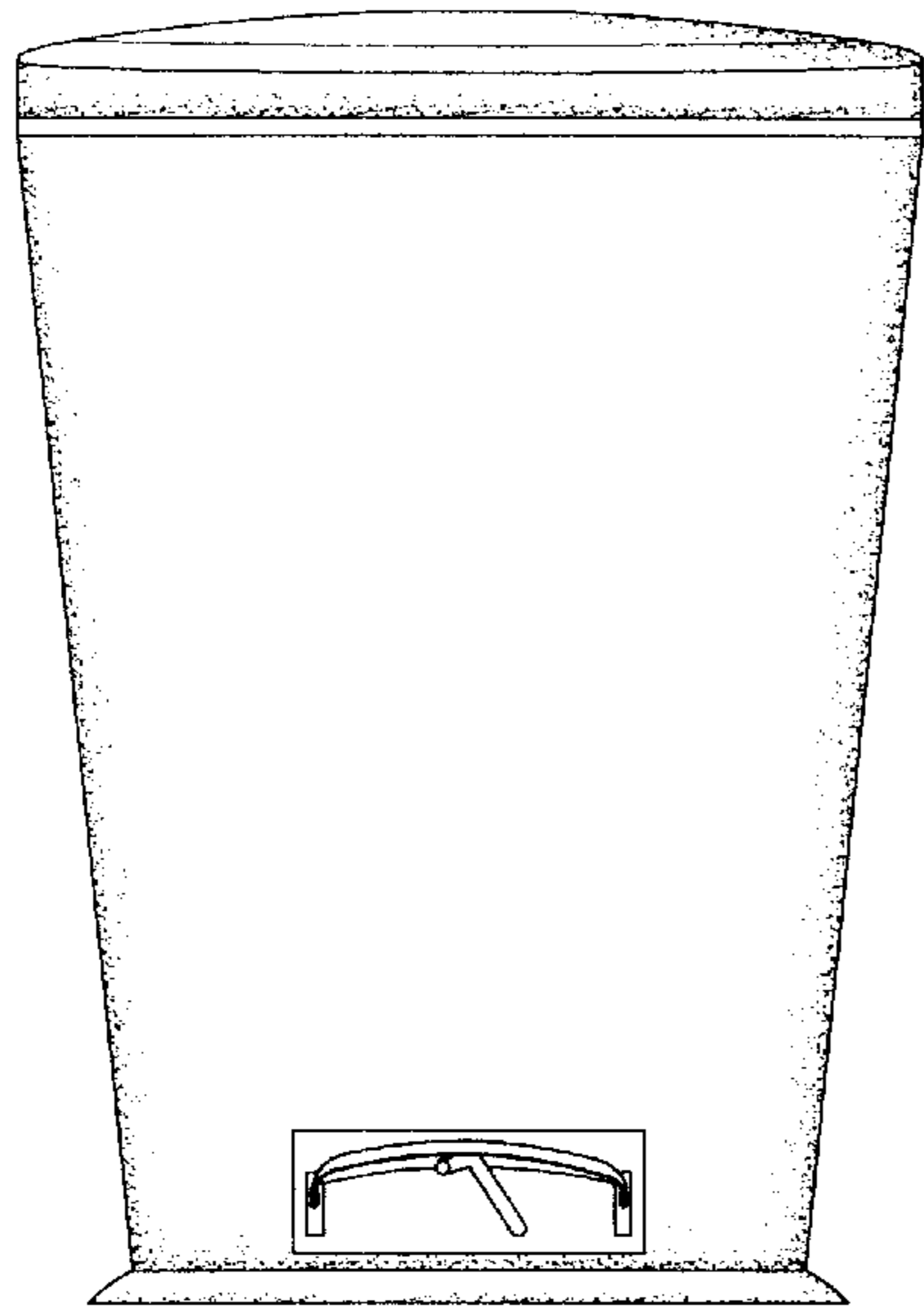

Fig. 2

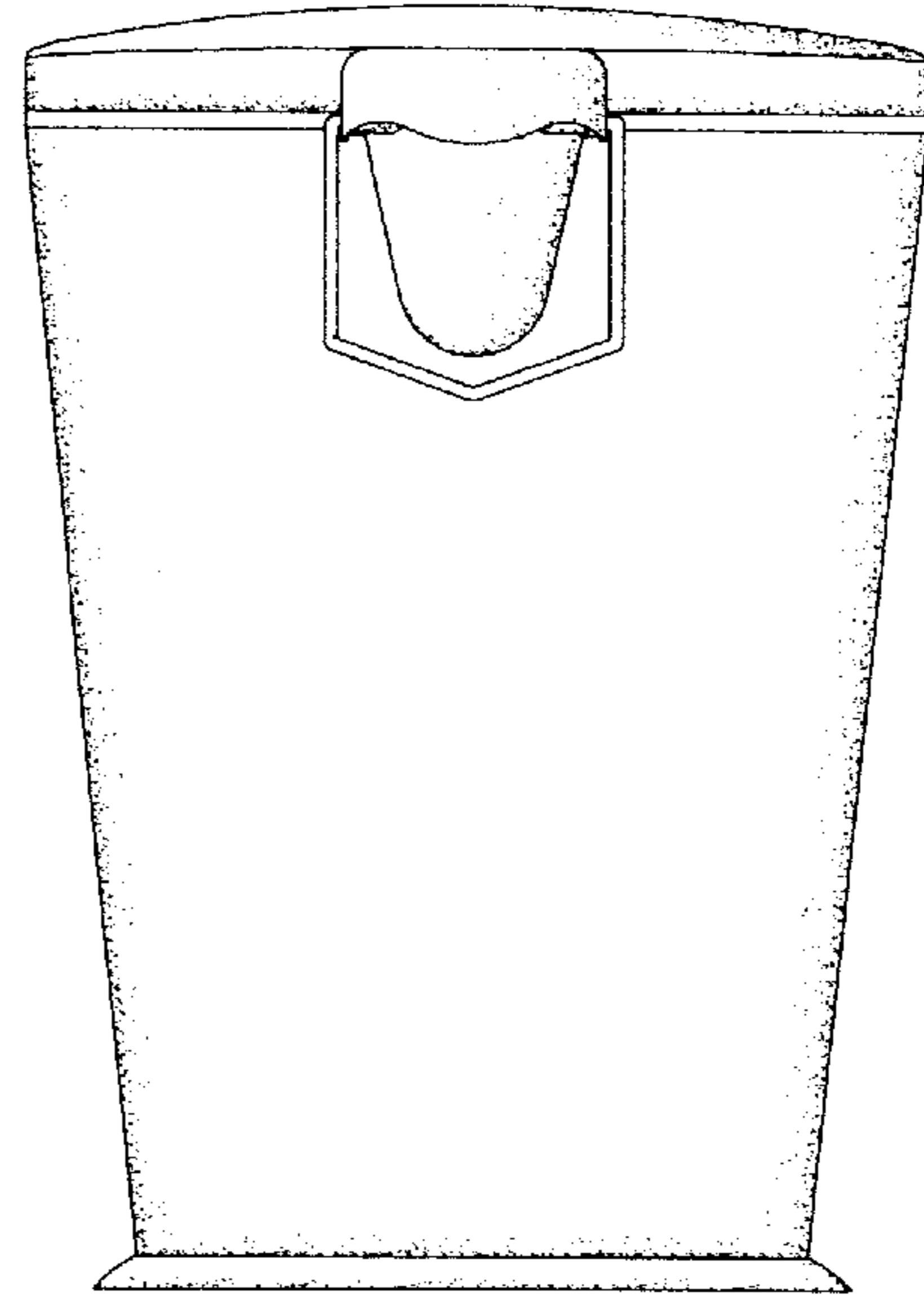

Fig. 3

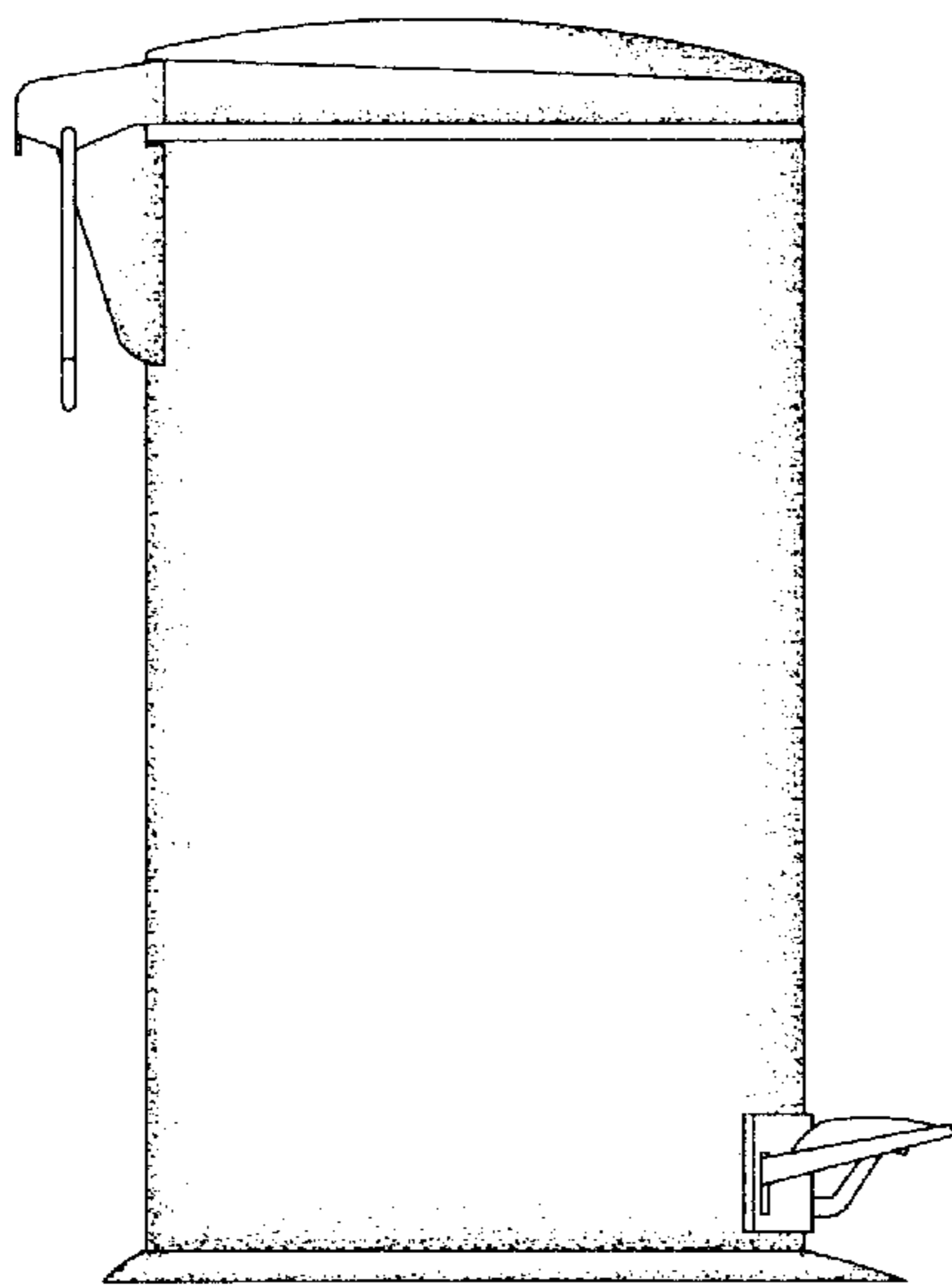

Fig. 4

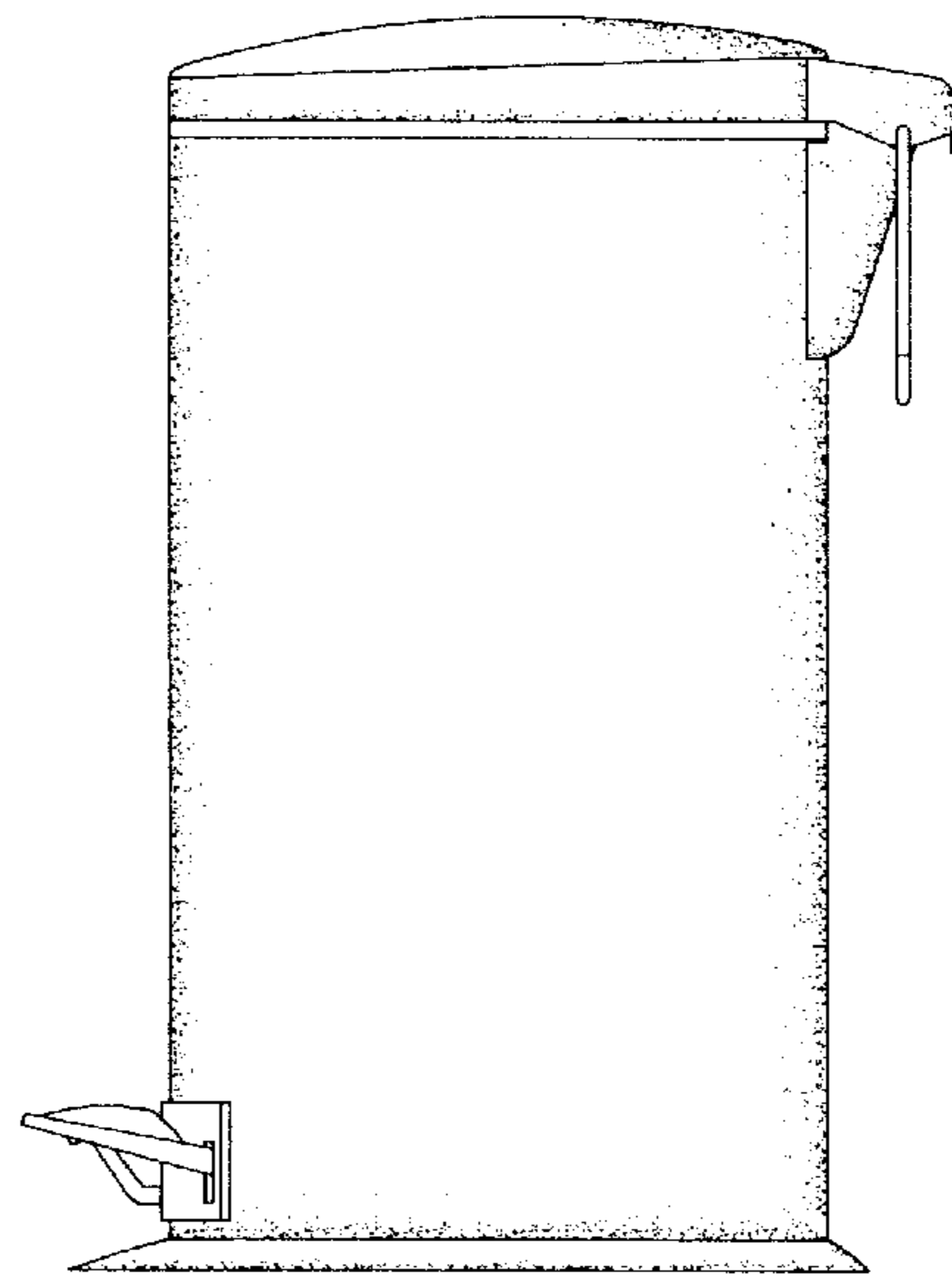

Fig. 5

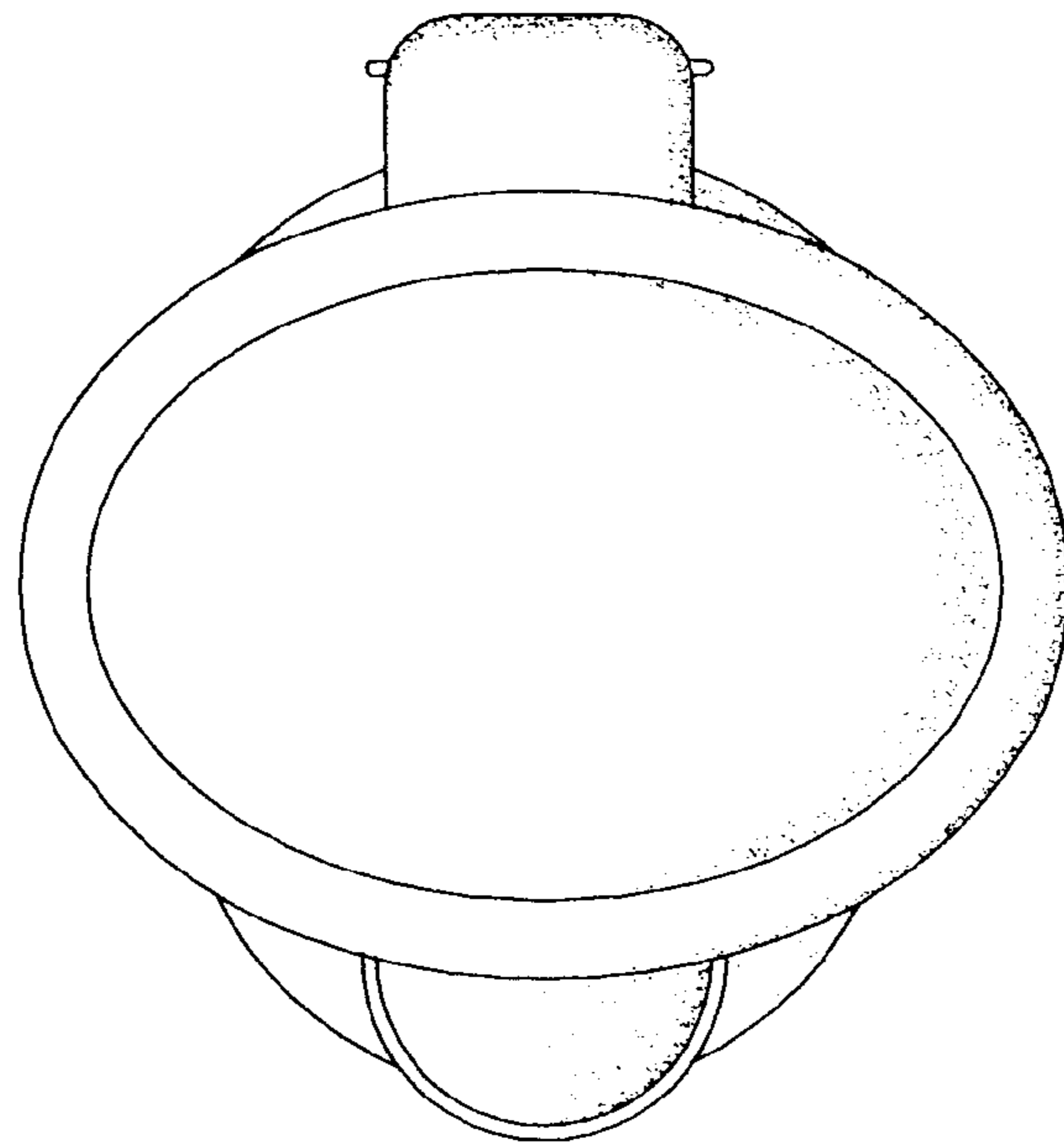

Fig. 6

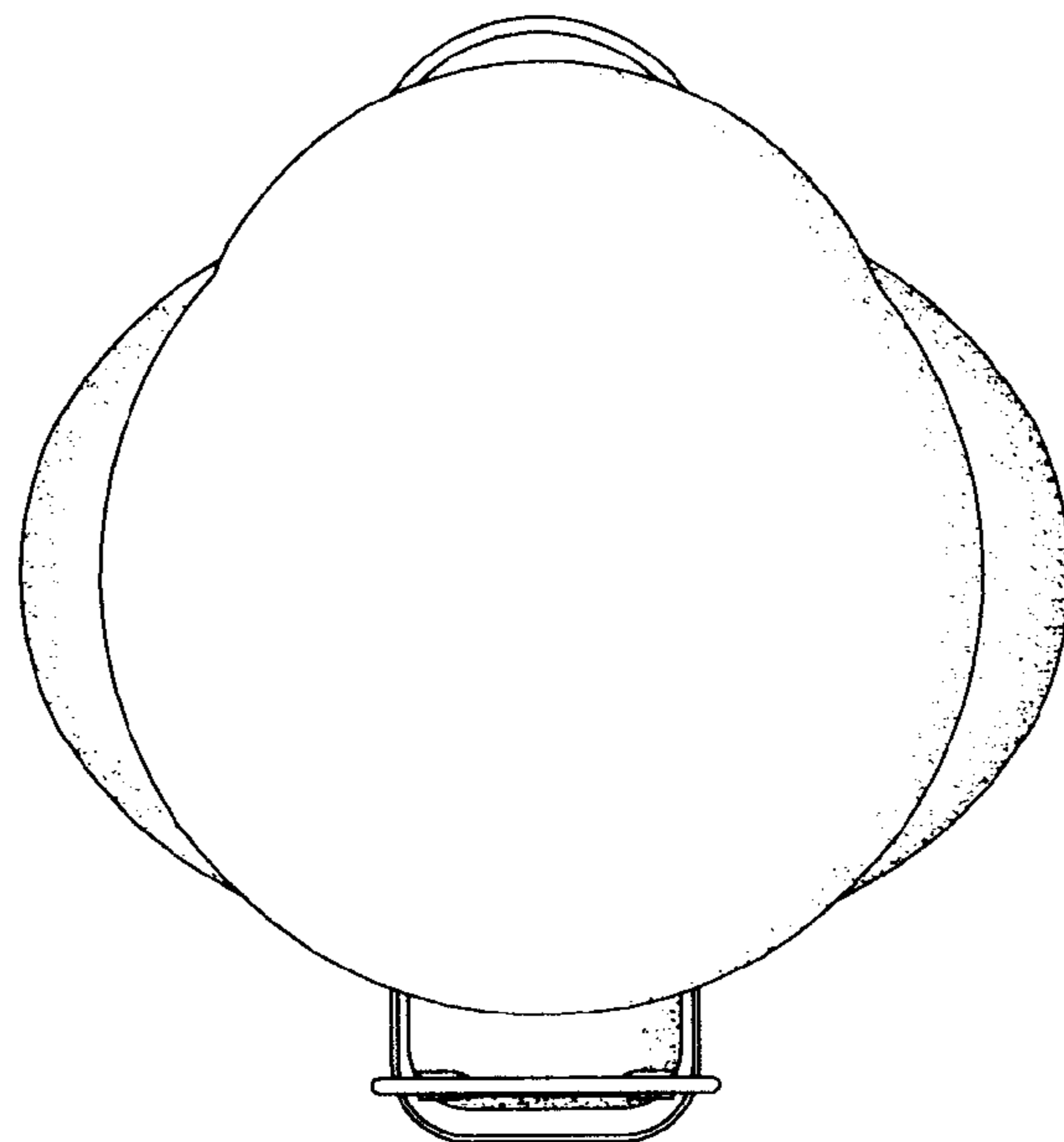

Fig. 7