



US00D530864S

(12) **United States Design Patent**
Huh

(10) **Patent No.:** **US D530,864 S**
(45) **Date of Patent:** **** Oct. 24, 2006**

(54) **WELDING MASK**
(75) Inventor: **Moon Young Huh**, Seoul (KR)
(73) Assignee: **Otos Tech Co., Ltd.**, Seoul (KR)
(**) Term: **14 Years**

D478,111 S 8/2003 Huh
D481,832 S 11/2003 Huh
D482,502 S 11/2003 Huh
D482,503 S 11/2003 Huh
D489,492 S * 5/2004 Wu D29/110

(21) Appl. No.: **29/223,100**
(22) Filed: **Feb. 9, 2005**

FOREIGN PATENT DOCUMENTS

KR 94-12068 6/1994
KR 0320527 7/2003

(51) **LOC (8) Cl.** **29-02**
(52) **U.S. Cl.** **D29/110**
(58) **Field of Classification Search** D29/102-110,
D29/122; 2/7-8, 15, 410, 424, 427, 429,
2/9, 431-433, 441; 219/147; 359/361; 434/234;
D24/110.2, 110.3; 128/206.21
See application file for complete search history.

OTHER PUBLICATIONS

U.S. Appl. No. 10/062,510, filed Feb. 5, 2002, Huh.

* cited by examiner

Primary Examiner—Ruth McInroy
(74) *Attorney, Agent, or Firm*—Roth & Goldman, P.A.

(56) **References Cited**

(57) **CLAIM**

The ornamental design for a welding mask, as shown.

U.S. PATENT DOCUMENTS

DESCRIPTION

3,517,393 A 6/1970 Beauchef
5,657,106 A 8/1997 Herald, Jr. et al.
D393,933 S 4/1998 Huh
D394,732 S * 5/1998 Huh D29/110
5,771,499 A 6/1998 Monaco et al.
D398,421 S * 9/1998 Crafoord et al. D29/110
6,038,707 A 3/2000 Ryden et al.
6,138,285 A 10/2000 Robrahn et al.
D446,887 S 8/2001 Young
6,450,639 B1 9/2002 Abraham

FIG. 1 is a perspective view showing my new design;
FIG. 2 is a front elevation view;
FIG. 3 is a rear elevation view;
FIG. 4 is a top plan view;
FIG. 5 is a bottom plan view; and,
FIG. 6 is a left side elevation view, the right side elevation
view being a mirror image thereof.

1 Claim, 6 Drawing Sheets

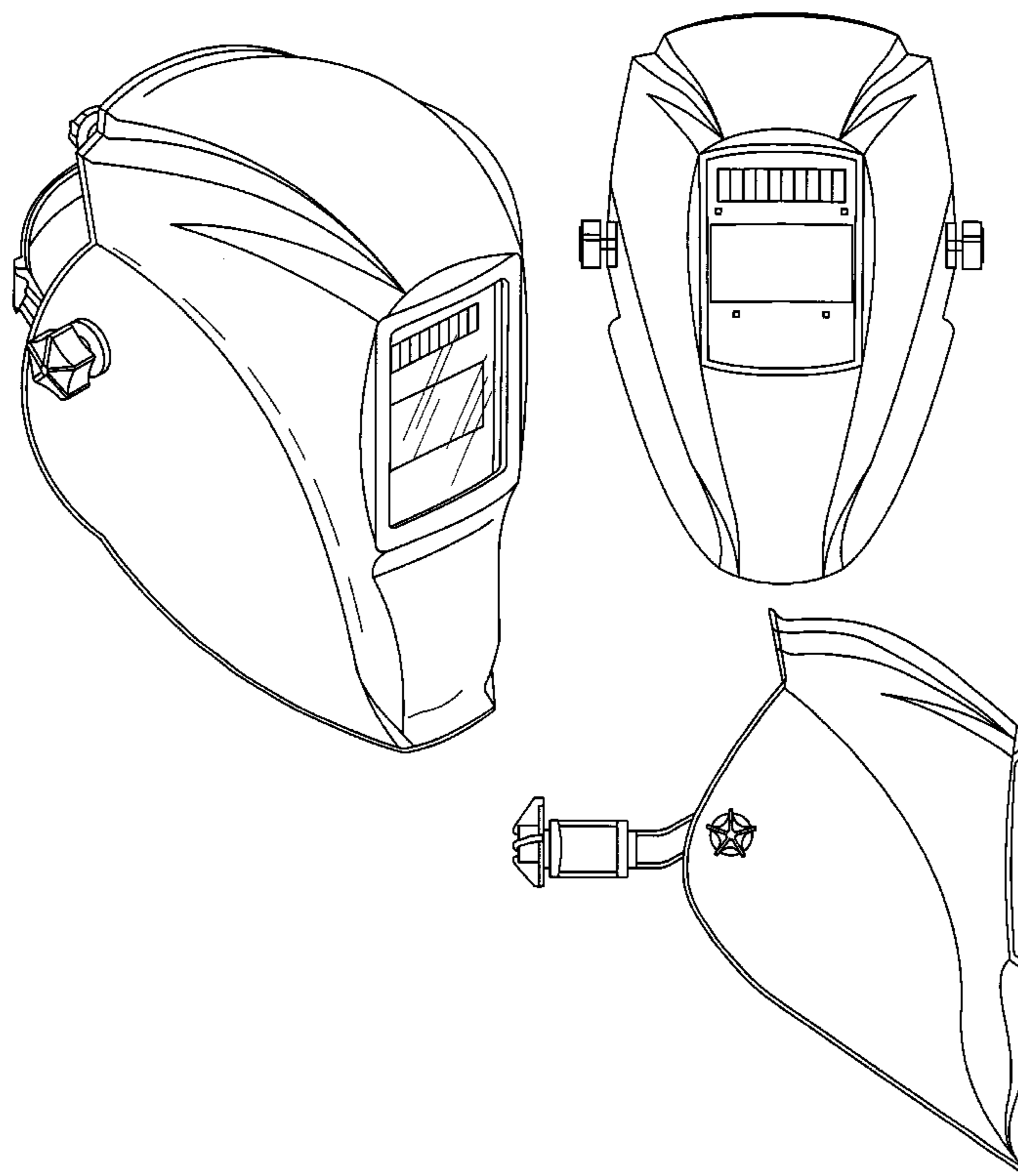

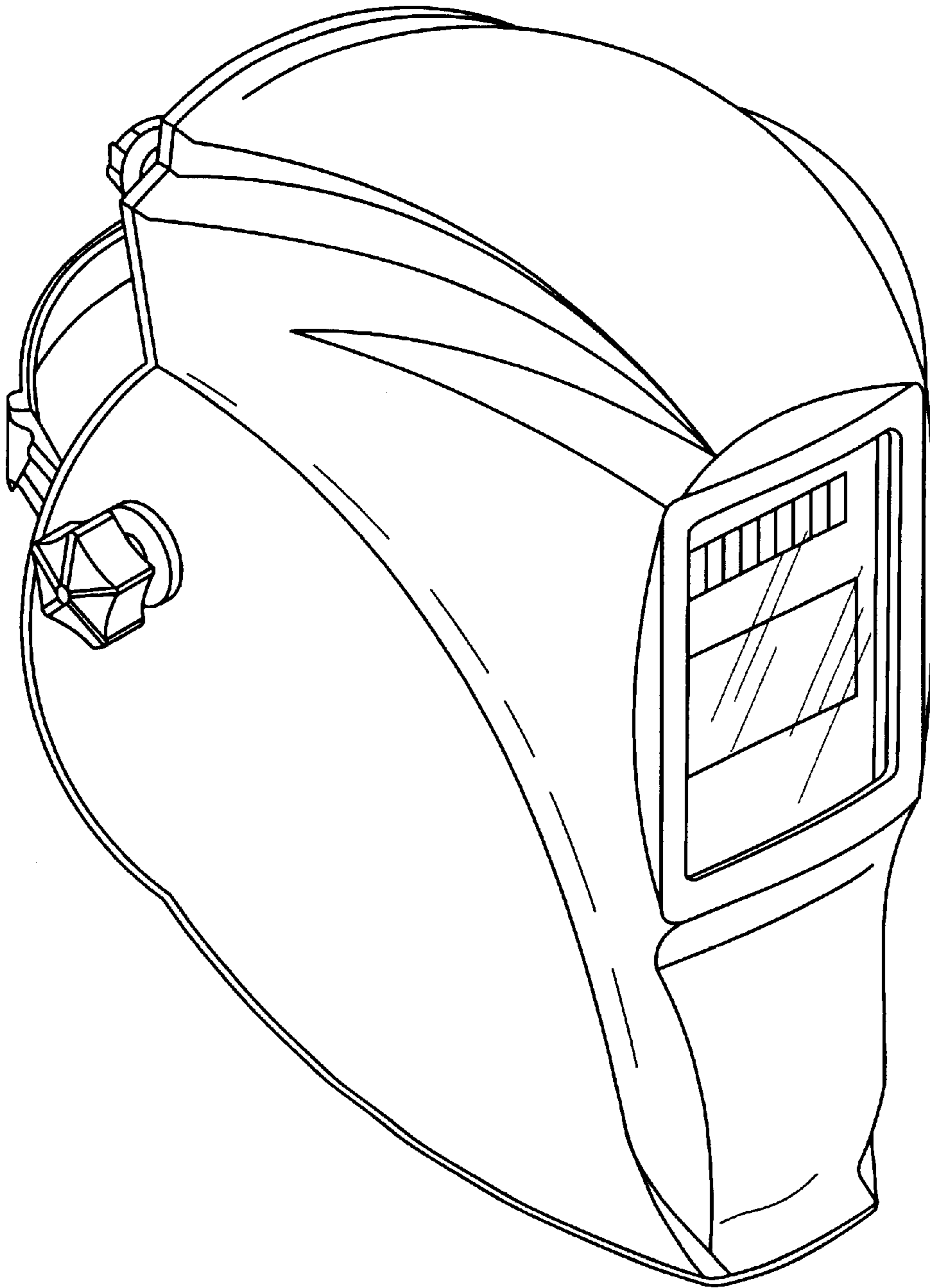

FIG. 1

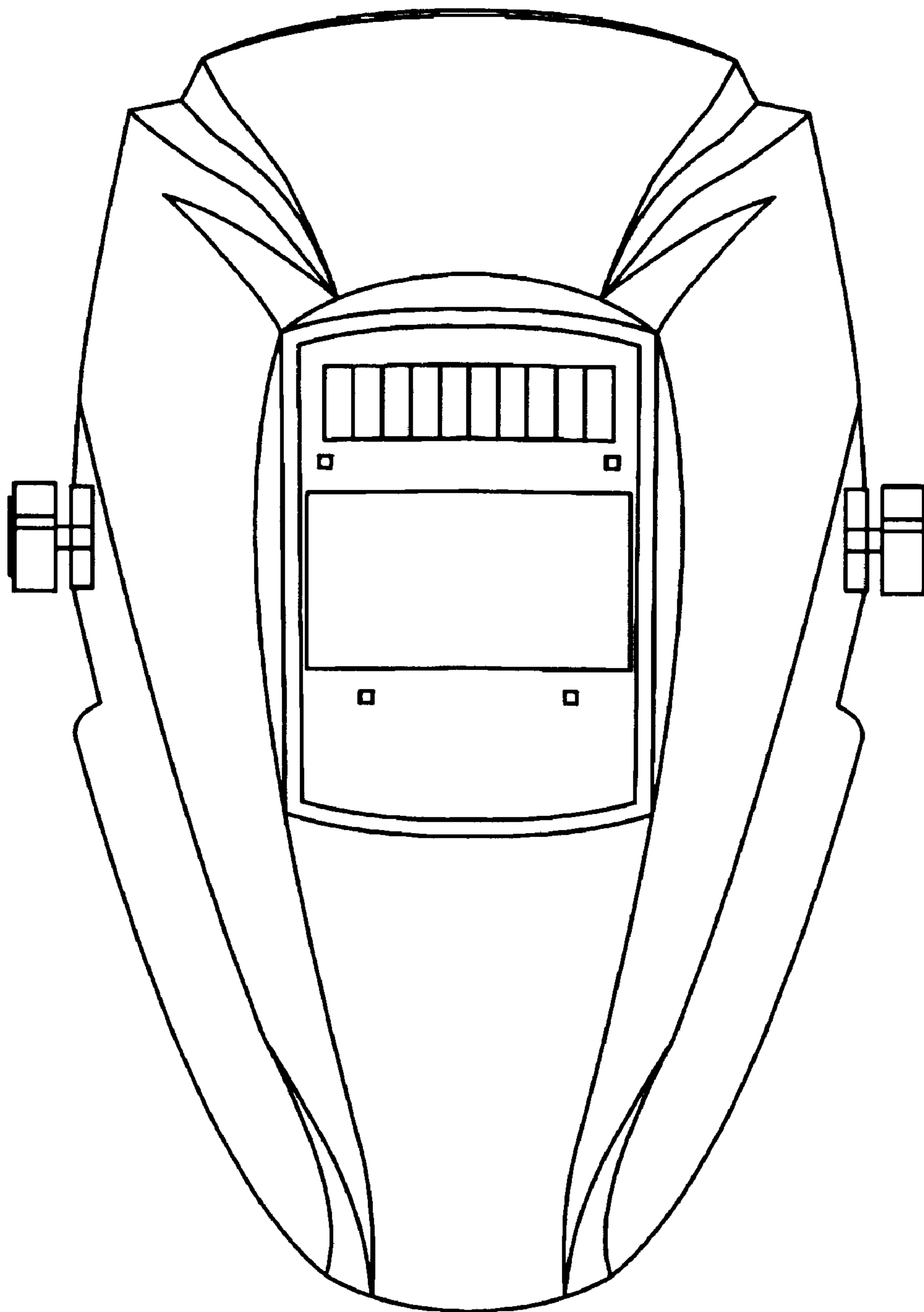

FIG. 2

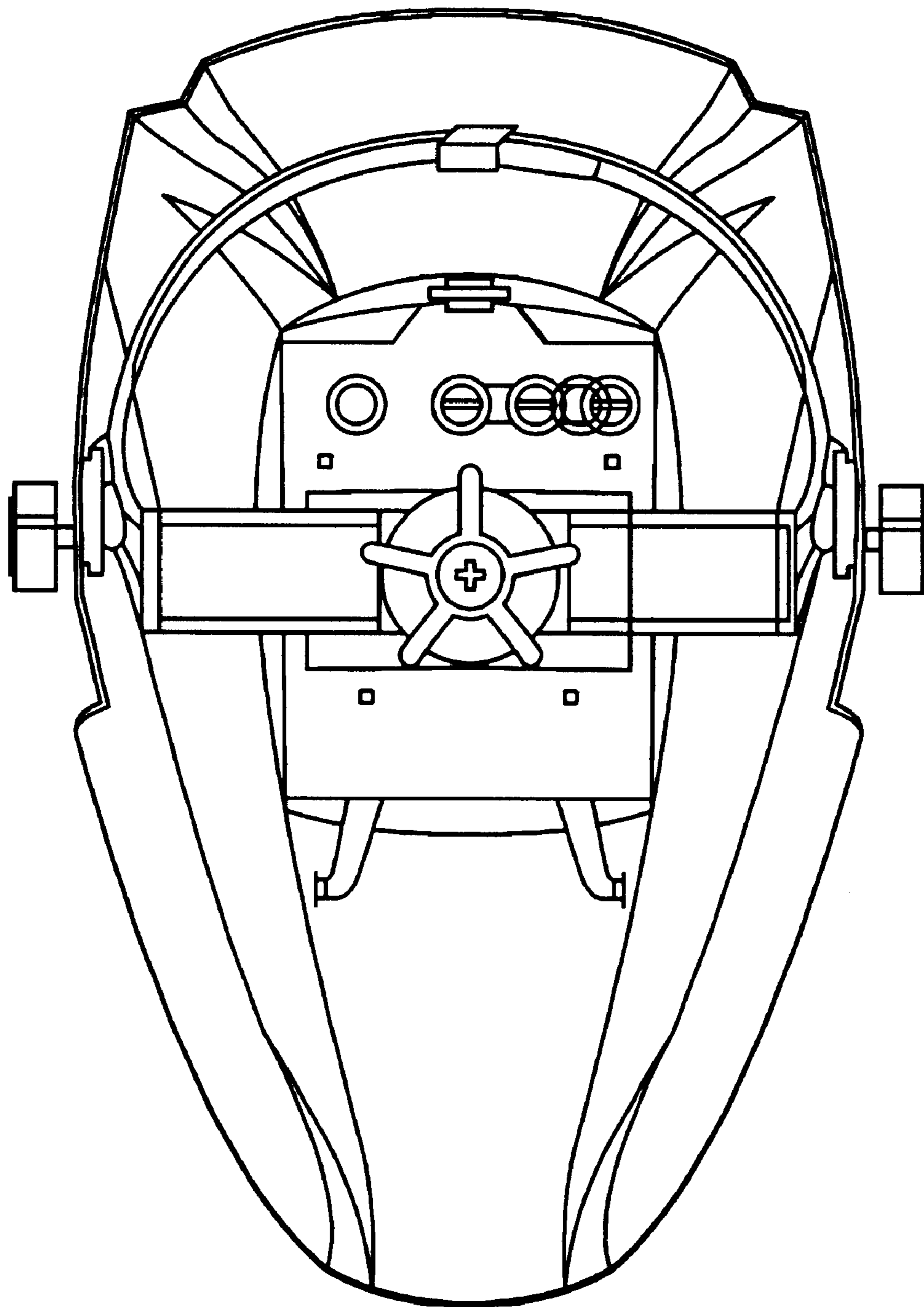

FIG. 3

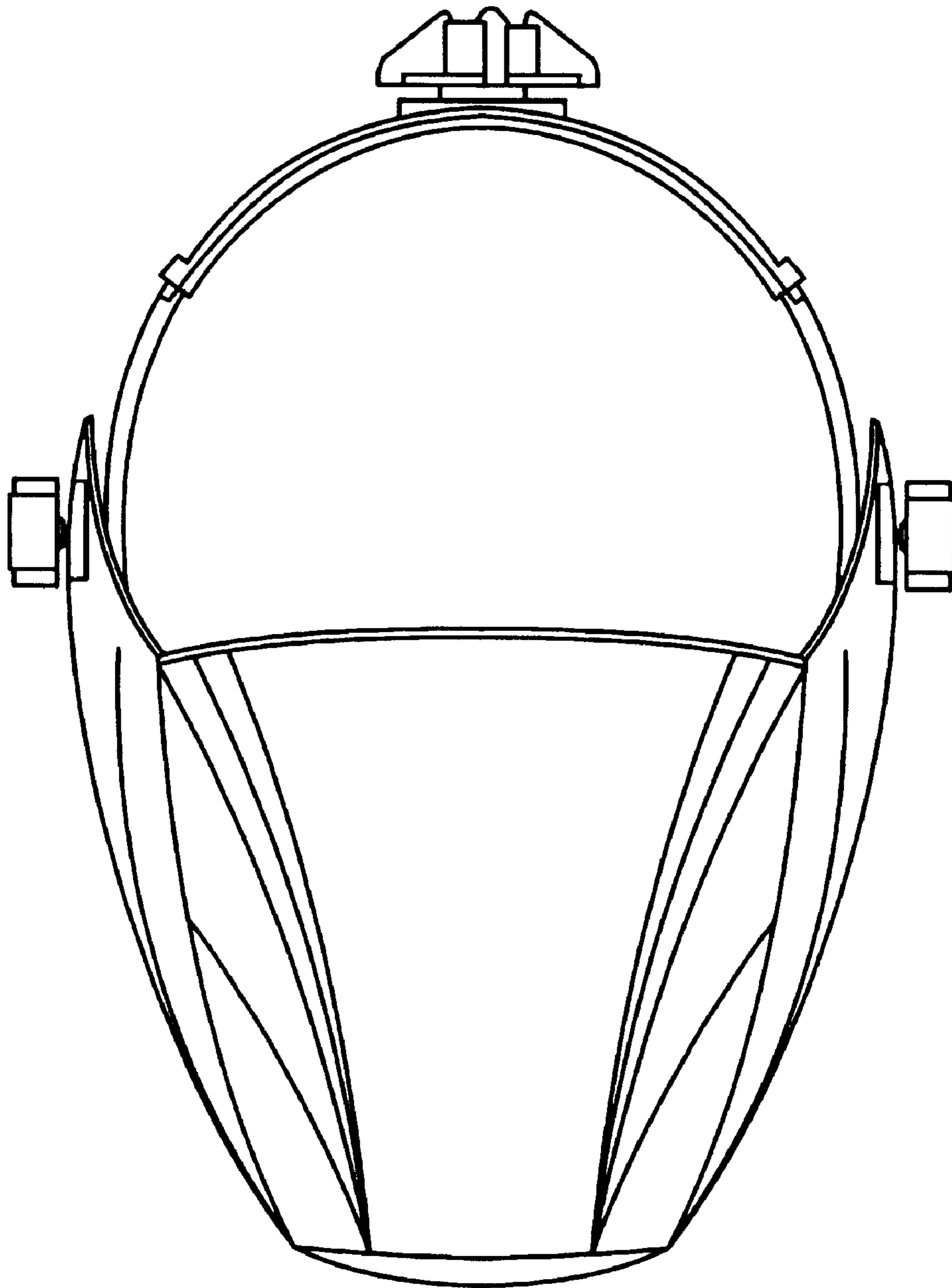

FIG. 4

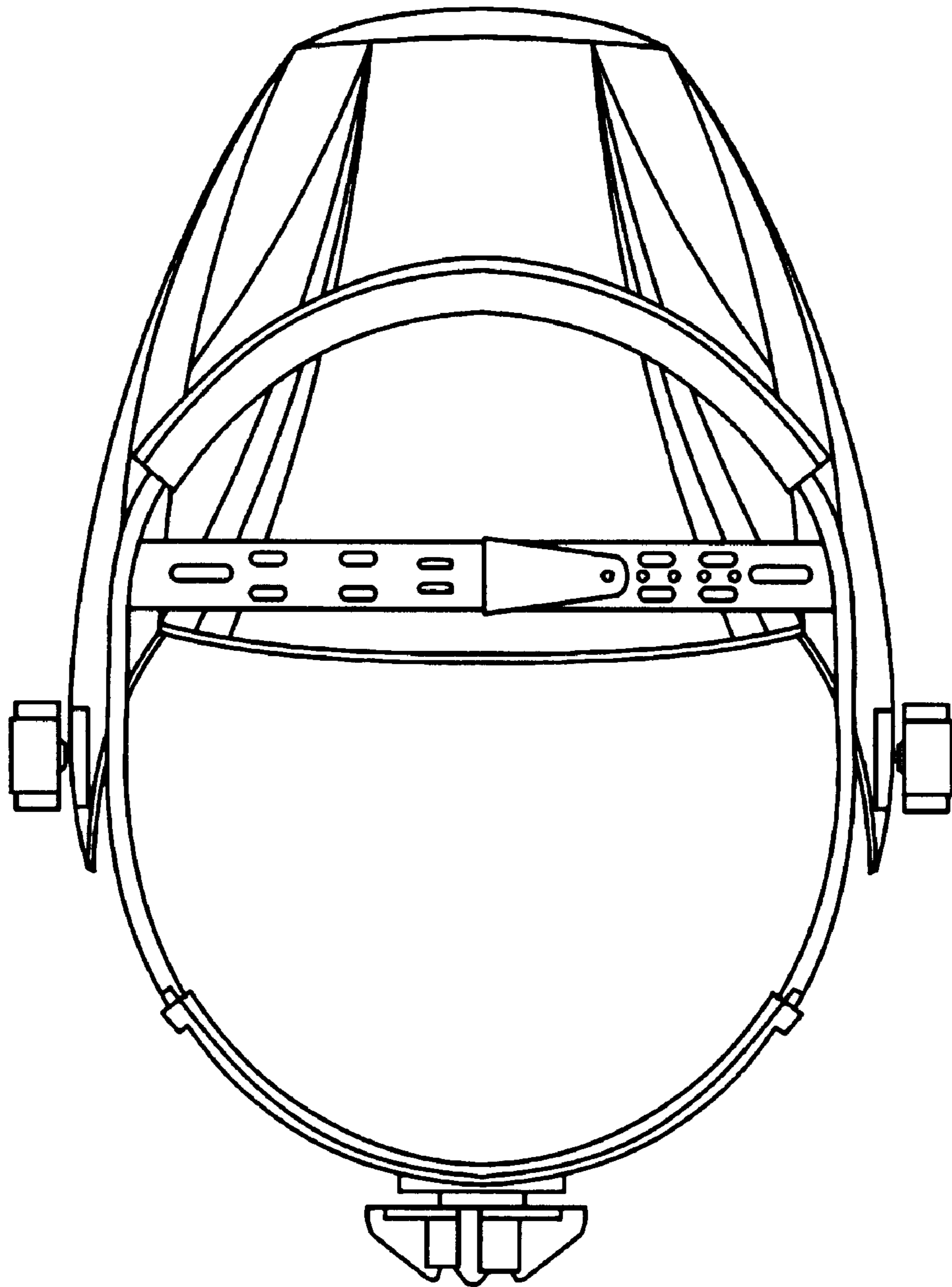

FIG. 5

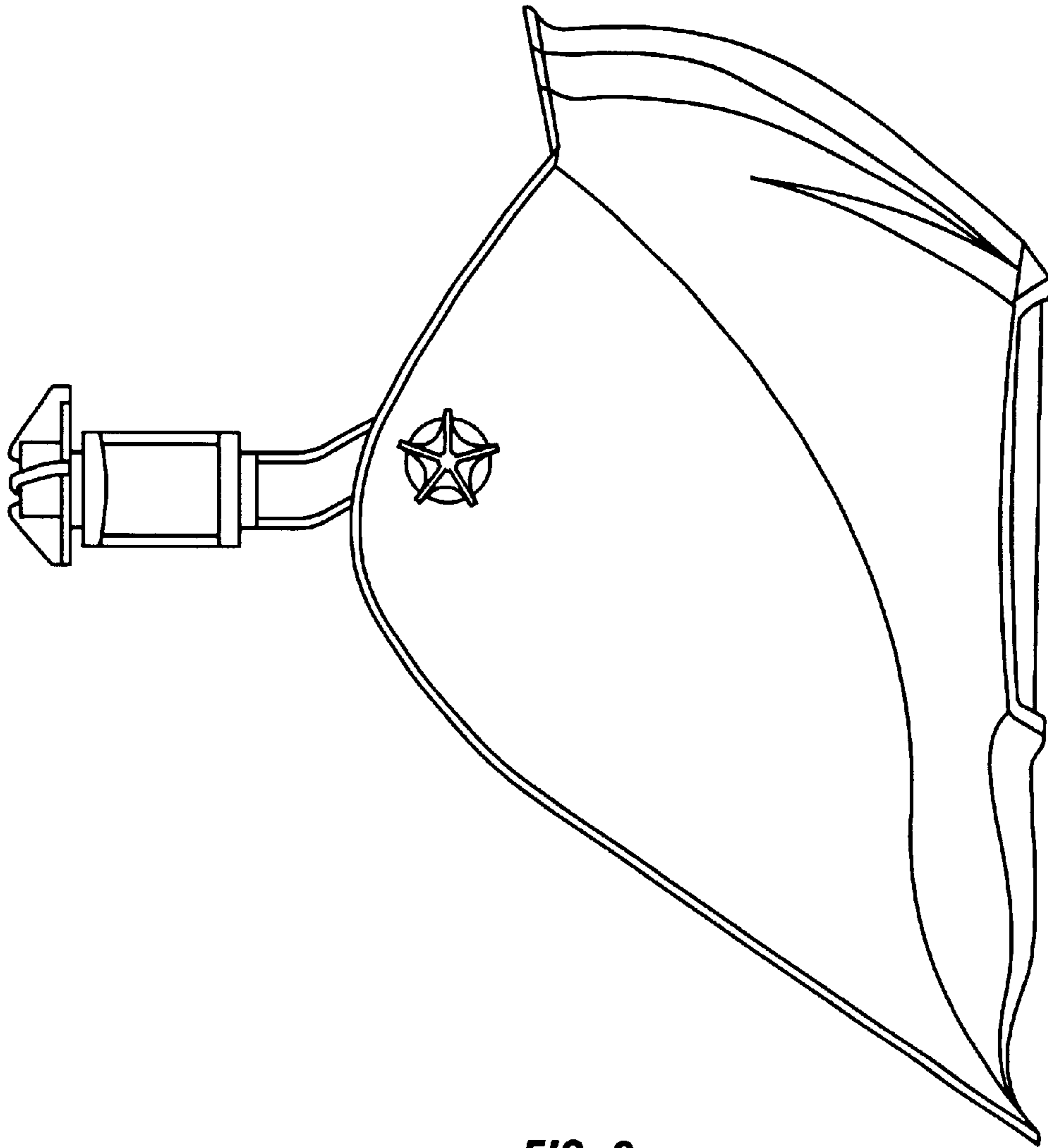

FIG. 6