



US00D530771S

(12) **United States Design Patent**  
**Peterson**

(10) **Patent No.:** **US D530,771 S**

(45) **Date of Patent:** **\*\* \*Oct. 24, 2006**

- (54) **INFLATABLE CANOPY LOUNGE**
- (75) Inventor: **Leroy L. Peterson**, Omaha, NE (US)
- (73) Assignee: **Sportsstuff, Inc.**, Omaha, NE (US)
- (\*) Notice: This patent is subject to a terminal disclaimer.
- (\*\*) Term: **14 Years**
- (21) Appl. No.: **29/227,818**
- (22) Filed: **Apr. 15, 2005**
- (51) **LOC (8) Cl.** ..... **21-02**
- (52) **U.S. Cl.** ..... **D21/809; D21/803**
- (58) **Field of Classification Search** ..... D21/769-770,  
D21/801, 803, 809; D6/392, 596, 601, 604;  
472/128-129; D12/5, 6, 316; 114/253, 345-346;  
441/35, 66, 40-42, 129-132  
See application file for complete search history.

- 5,766,052 A \* 6/1998 Metro et al. .... 441/130
- 5,769,022 A \* 6/1998 Luxford ..... 114/361
- D428,090 S \* 7/2000 Peterson ..... D21/803
- D435,824 S \* 1/2001 Peterson ..... D12/316
- D435,826 S \* 1/2001 Peterson ..... D12/316
- D492,380 S \* 6/2004 Zheng ..... D21/809

**FOREIGN PATENT DOCUMENTS**

DE 3106689 A1 \* 9/1982

**OTHER PUBLICATIONS**

The Sharper Image, Jun. 1997, p. 13, 'Azure Cabana Float' located on the lower right area of the page.\*

\* cited by examiner

*Primary Examiner*—Caron D. Veynar  
*Assistant Examiner*—Zenia I. Bennett  
(74) *Attorney, Agent, or Firm*—Sturm & Fix LLP

(57) **CLAIM**

The ornamental design for an inflatable canopy lounge, as shown and described.

**DESCRIPTION**

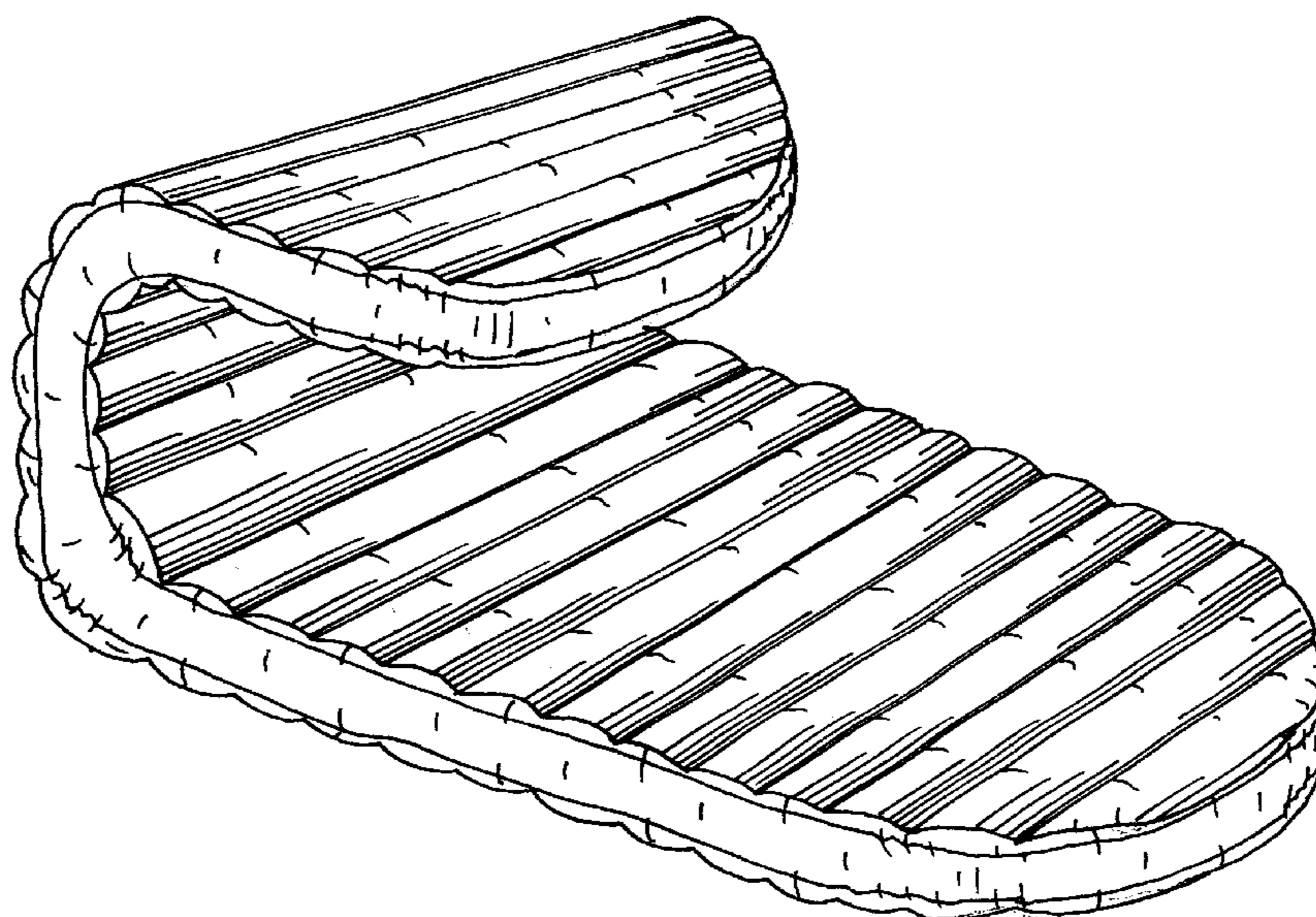
FIG. 1 is a perspective view of the inflatable canopy lounge showing my new design;  
FIG. 2 is a left side elevational view thereof, the right side elevational view being a mirror image of FIG. 2;  
FIG. 3 is a top plan view thereof;  
FIG. 4 is a front elevational view thereof;  
FIG. 5 is a rear elevational view thereof; and,  
FIG. 6 is a bottom plan view thereof.

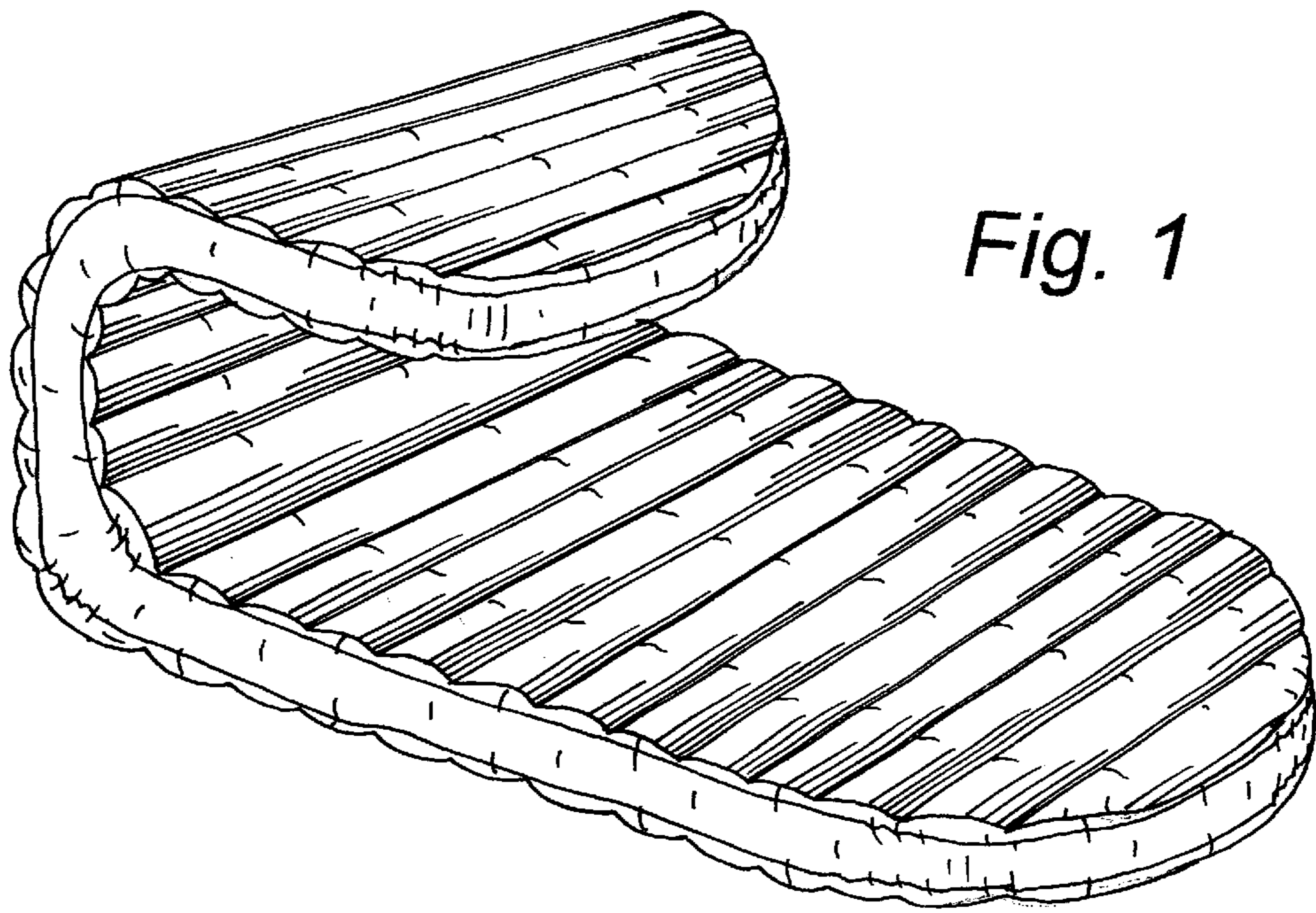
**1 Claim, 2 Drawing Sheets**

(56) **References Cited**

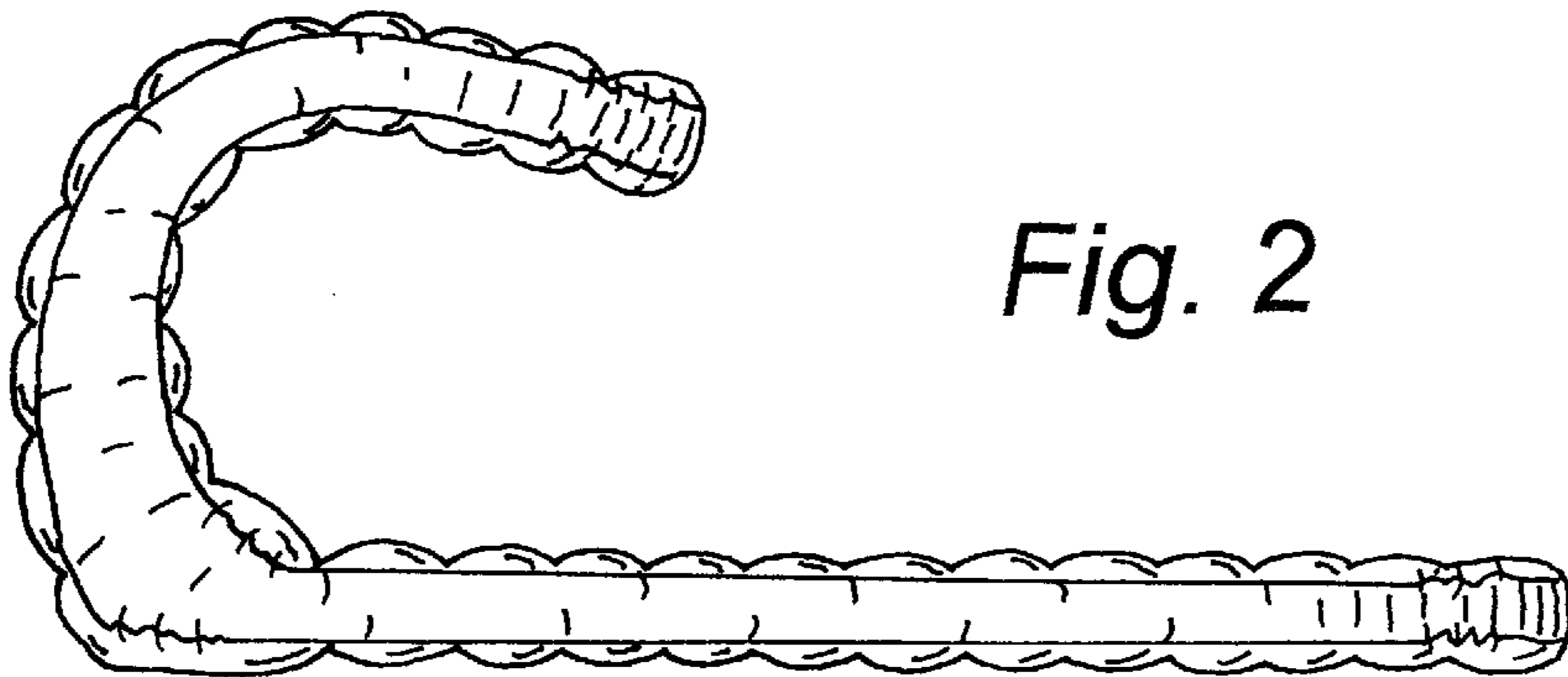
**U.S. PATENT DOCUMENTS**

- 2,036,548 A \* 4/1936 Silvernail ..... 441/66
- 3,030,640 A \* 4/1962 Gosman ..... 441/40
- D206,335 S \* 11/1966 Solipasso ..... D12/11
- D220,953 S \* 6/1971 Des Pres ..... D6/361
- D315,187 S \* 3/1991 Thomas ..... D21/809
- D351,009 S \* 9/1994 Wolfe ..... D21/809
- D353,967 S \* 1/1995 Moore ..... D6/604
- 5,458,517 A \* 10/1995 Ellis ..... 441/129
- D366,084 S \* 1/1996 Wolfe ..... D21/809
- D375,989 S \* 11/1996 Jacobs ..... D21/809
- D393,683 S \* 4/1998 Song et al. .... D21/803

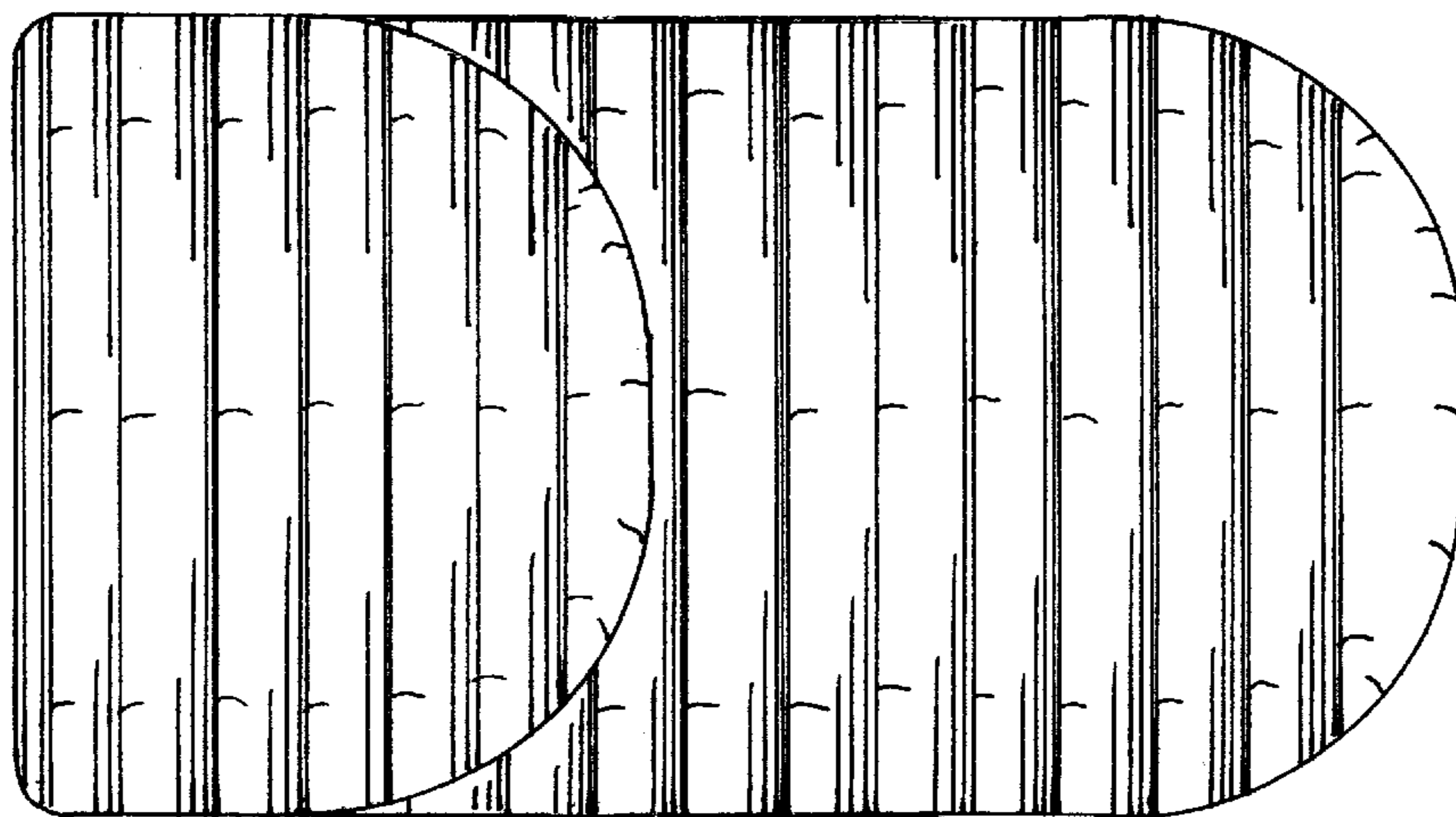




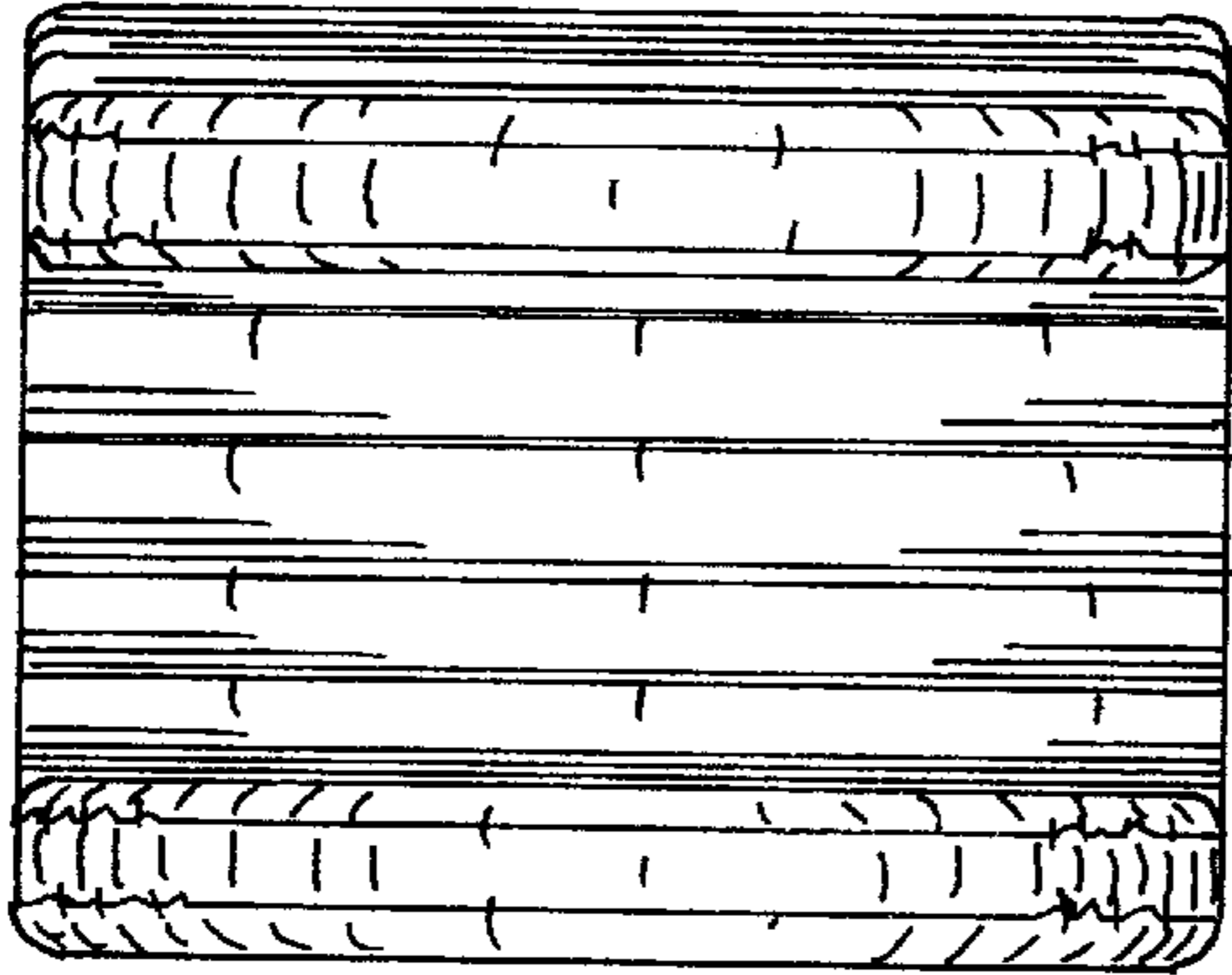
*Fig. 1*



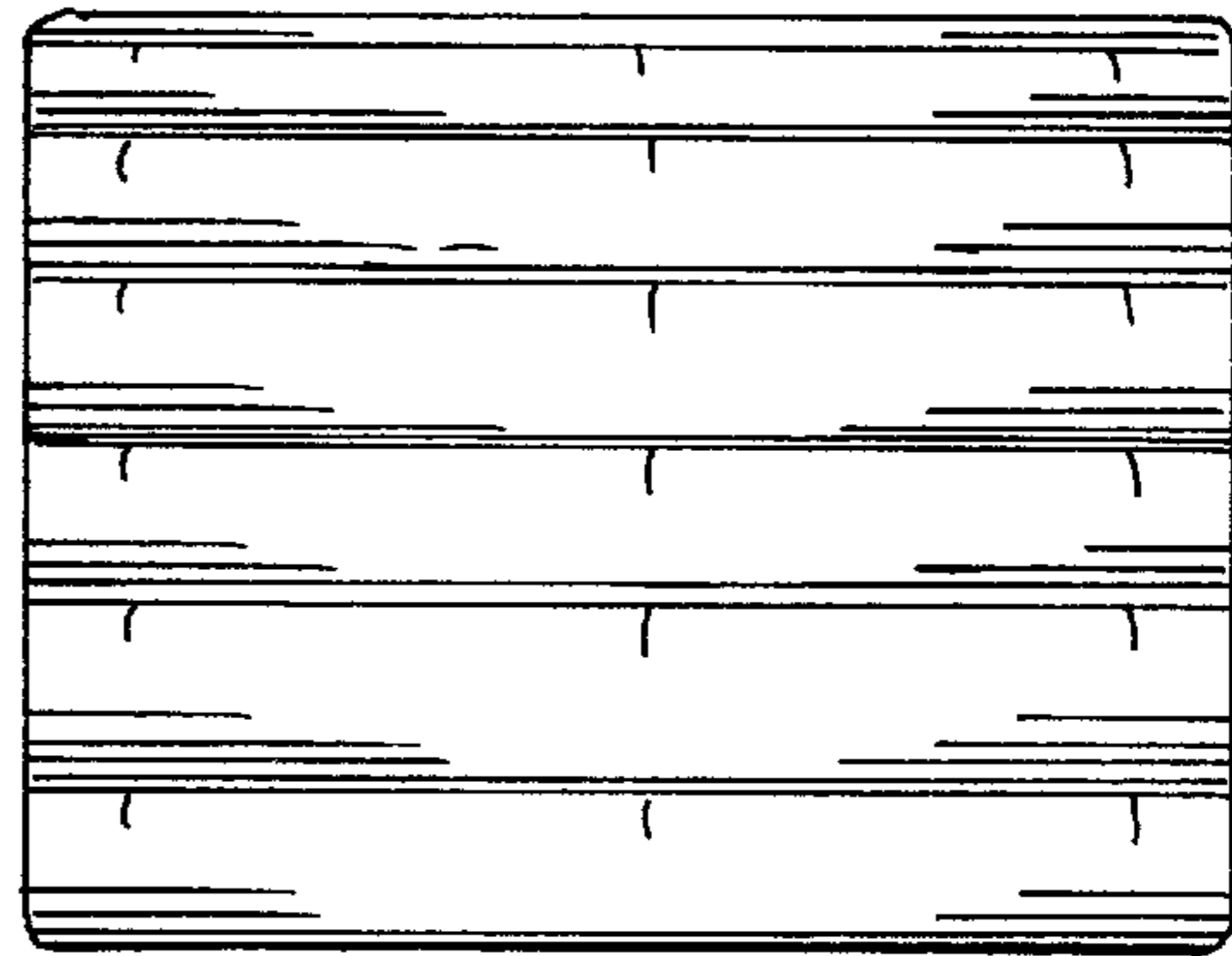
*Fig. 2*



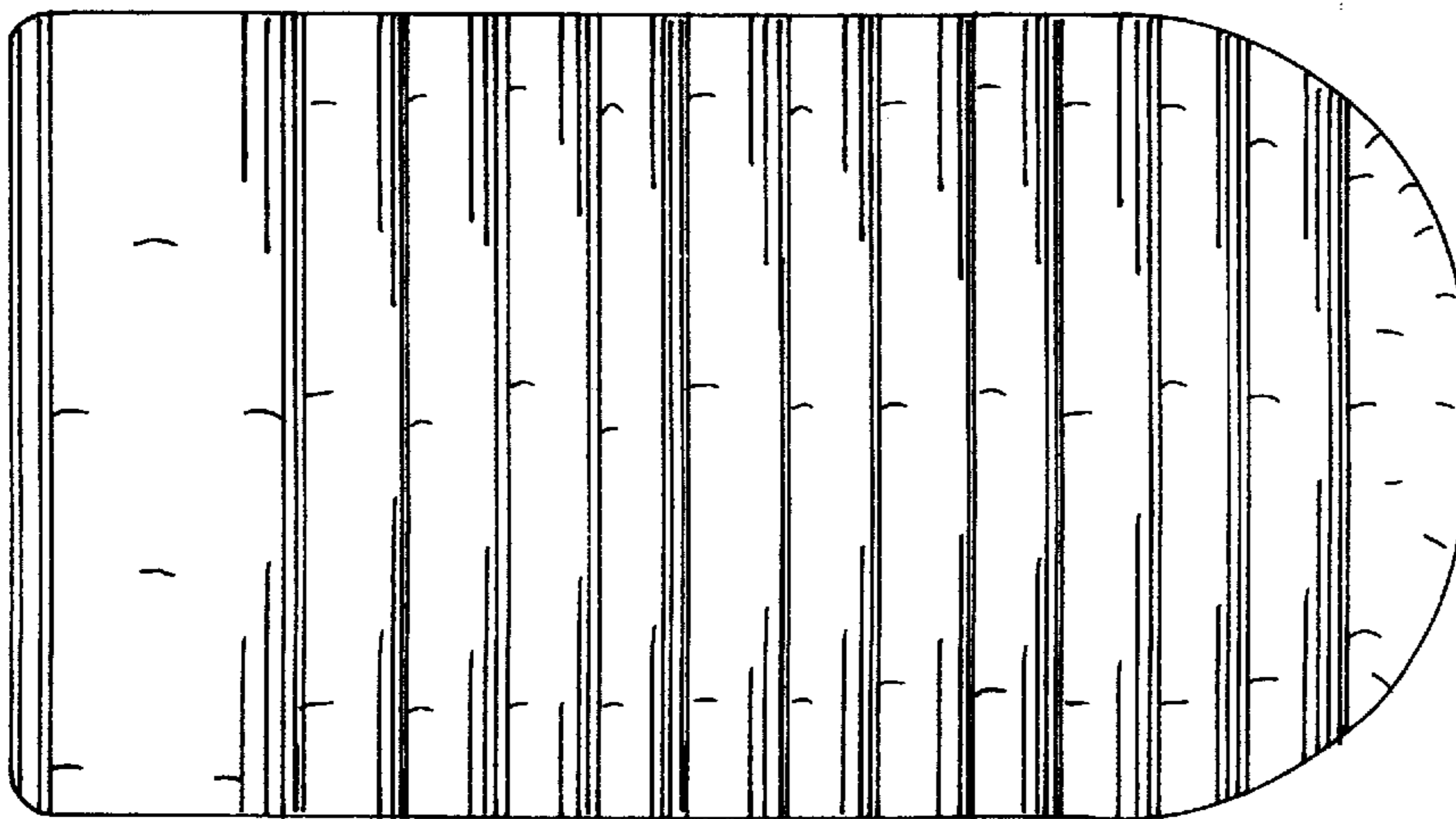
*Fig. 3*



*Fig. 4*



*Fig. 5*



*Fig. 6*