



US00D530760S

(12) **United States Design Patent**  
**Schweigert et al.**

(10) **Patent No.:** **US D530,760 S**  
(45) **Date of Patent:** **\*\* Oct. 24, 2006**

(54) **GOLF IRON HEAD**

D502,975 S 3/2005 Schweigert  
D508,099 S \* 8/2005 Schweigert et al. .... D21/749

(75) Inventors: **Bradley D. Schweigert**, Anthem, AZ (US); **Michael R. Nicolette**, Scottsdale, AZ (US); **Marty R. Jertson**, Phoenix, AZ (US); **John A. Solheim**, Phoenix, AZ (US); **Eric V. Cole**, Phoenix, AZ (US)

\* cited by examiner

*Primary Examiner*—Mitchell Siegel  
(74) *Attorney, Agent, or Firm*—Darrell F. Marquette

(73) Assignee: **Karsten Manufacturing Corporation**, Phoenix, AZ (US)

(57) **CLAIM**

The ornamental design for a golf iron head, as shown and described.

(\*\*) Term: **14 Years**

**DESCRIPTION**

(21) Appl. No.: **29/230,838**

(22) Filed: **May 25, 2005**

(51) **LOC (8) Cl.** ..... **21-02**

(52) **U.S. Cl.** ..... **D21/749**

(58) **Field of Classification Search** ..... D21/747–751;  
473/324–331, 350

See application file for complete search history.

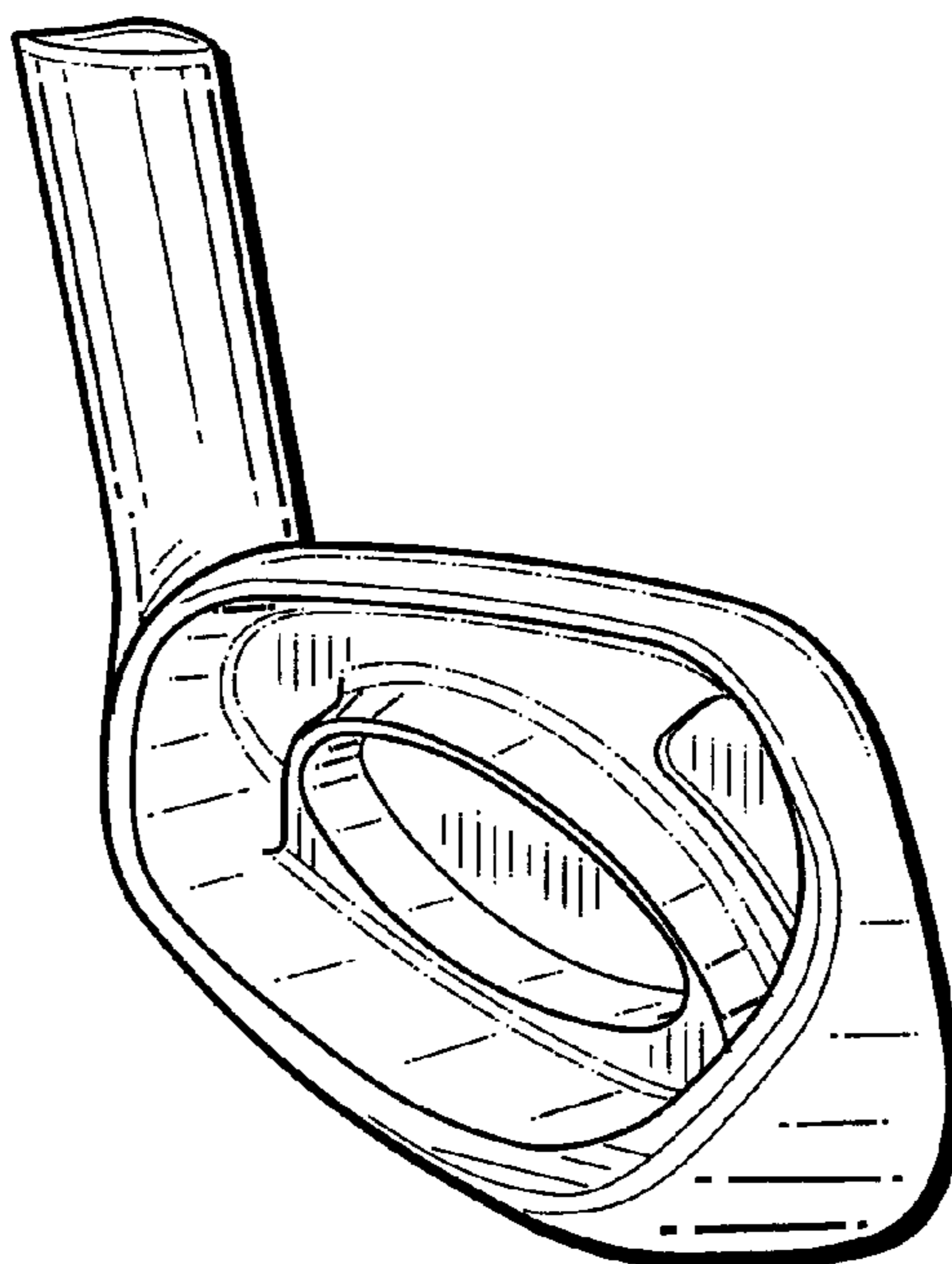
FIG. 1 is a perspective view of a golf iron head with a low loft angle such as a 2-iron showing our new design; FIG. 2 is a toe end view of the golf iron head of FIG. 1; FIG. 3 is a heel end view of the golf iron head of FIG. 1; FIG. 4 is a top view of the golf iron head of FIG. 1; FIG. 5 is a bottom view of the golf iron head of FIG. 1; FIG. 6 is a front elevational view of the golf iron head of FIG. 1; FIG. 7 is a rear elevational view of the golf iron head of FIG. 1; FIG. 8 is a perspective view of a golf iron head with a medium loft angle such as a 5-iron showing our new design; FIG. 9 is a toe end view of the golf iron head of FIG. 8; FIG. 10 is a heel end view of the golf iron head of FIG. 8; FIG. 11 is a top view of the golf iron head of FIG. 8; FIG. 12 is a bottom view of the golf iron head of FIG. 8; FIG. 13 is a front elevational view of the golf iron head of FIG. 8; and, FIG. 14 is a rear elevational view of the golf iron head of FIG. 8.

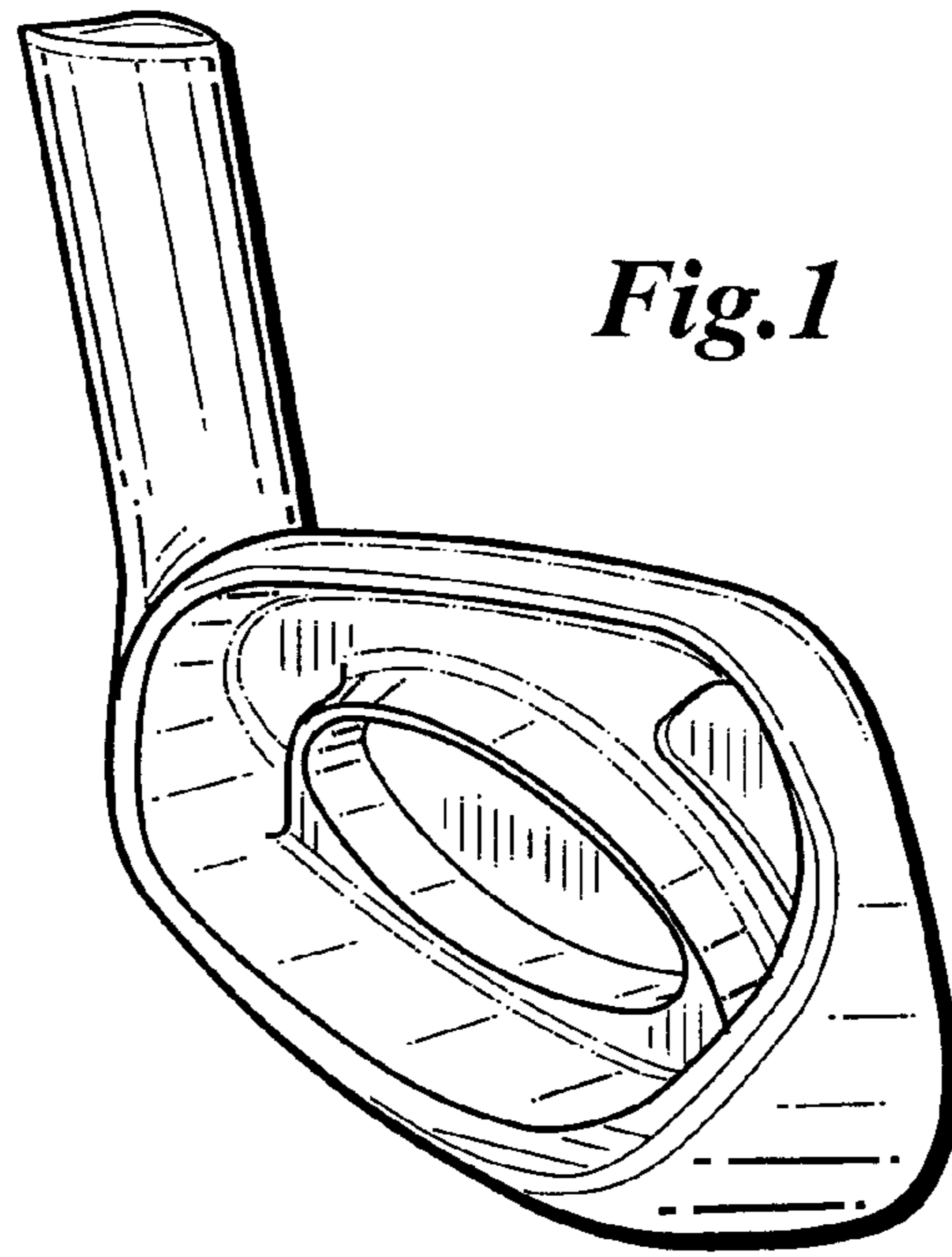
(56) **References Cited**

**U.S. PATENT DOCUMENTS**

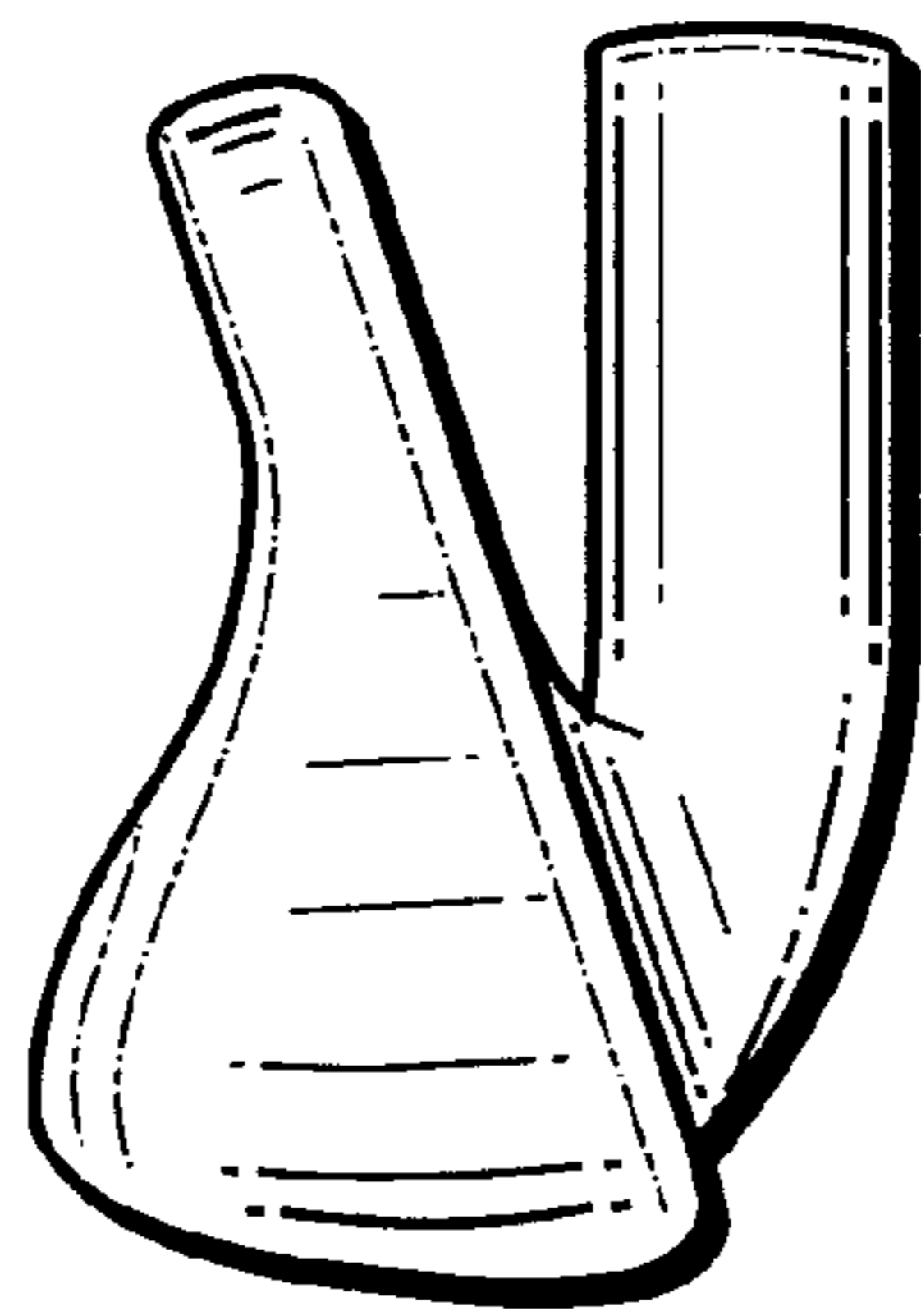
D256,264 S	8/1980	Solheim	
D379,393 S	5/1997	Kubica	
D422,043 S	3/2000	Kubica	
D429,299 S	8/2000	Kubica	
D442,659 S	5/2001	Kubica	
D443,008 S	5/2001	Kubica	
D470,554 S	* 2/2003	Truesdale	..... D21/747
D494,648 S	8/2004	Schweigert	
D500,350 S	12/2004	Schweigert	
D502,237 S	2/2005	Schweigert	

**1 Claim, 4 Drawing Sheets**

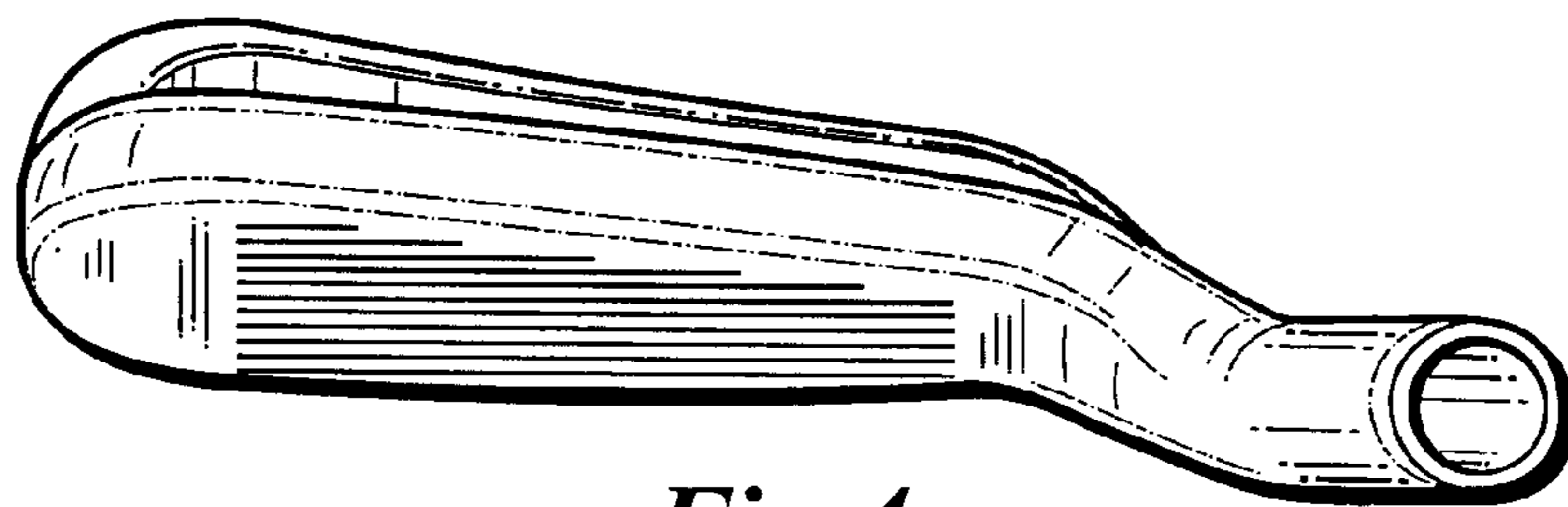
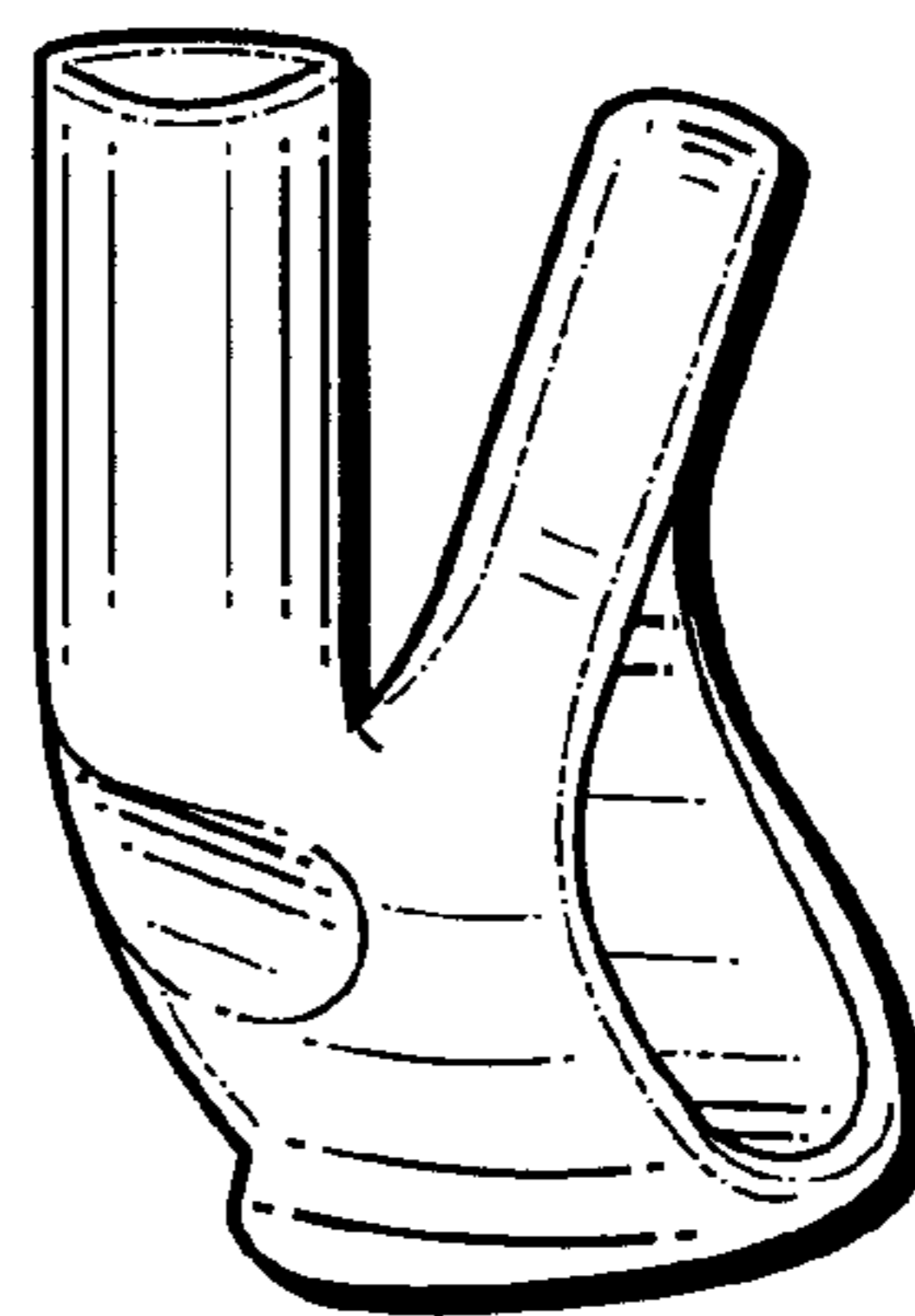




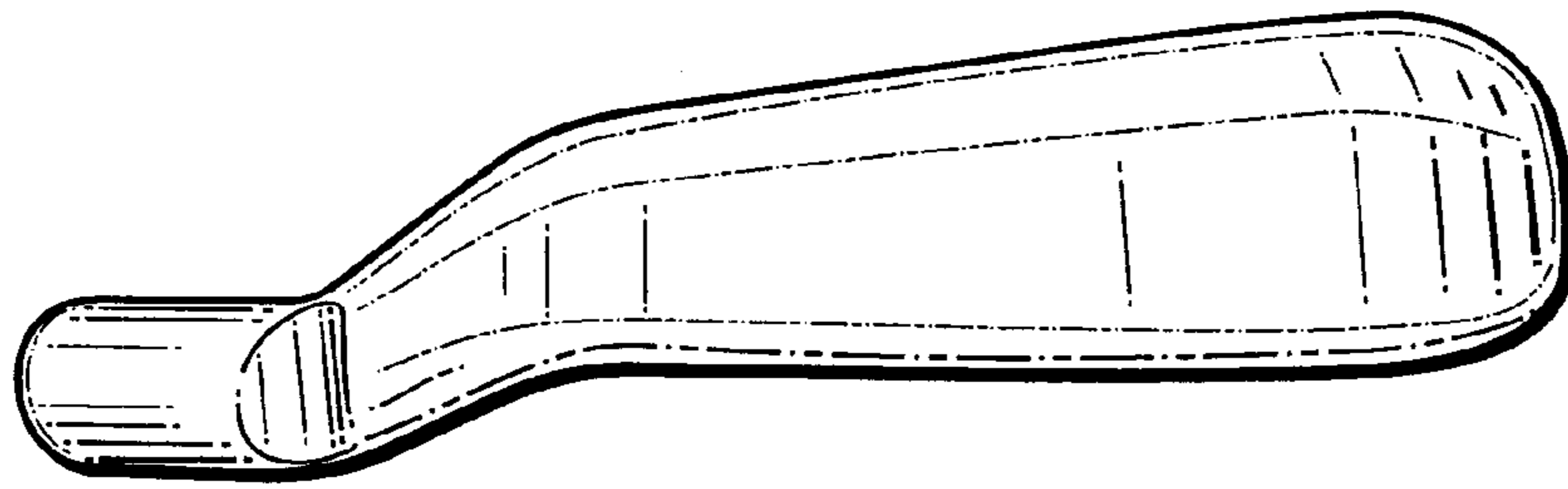
*Fig. 2*



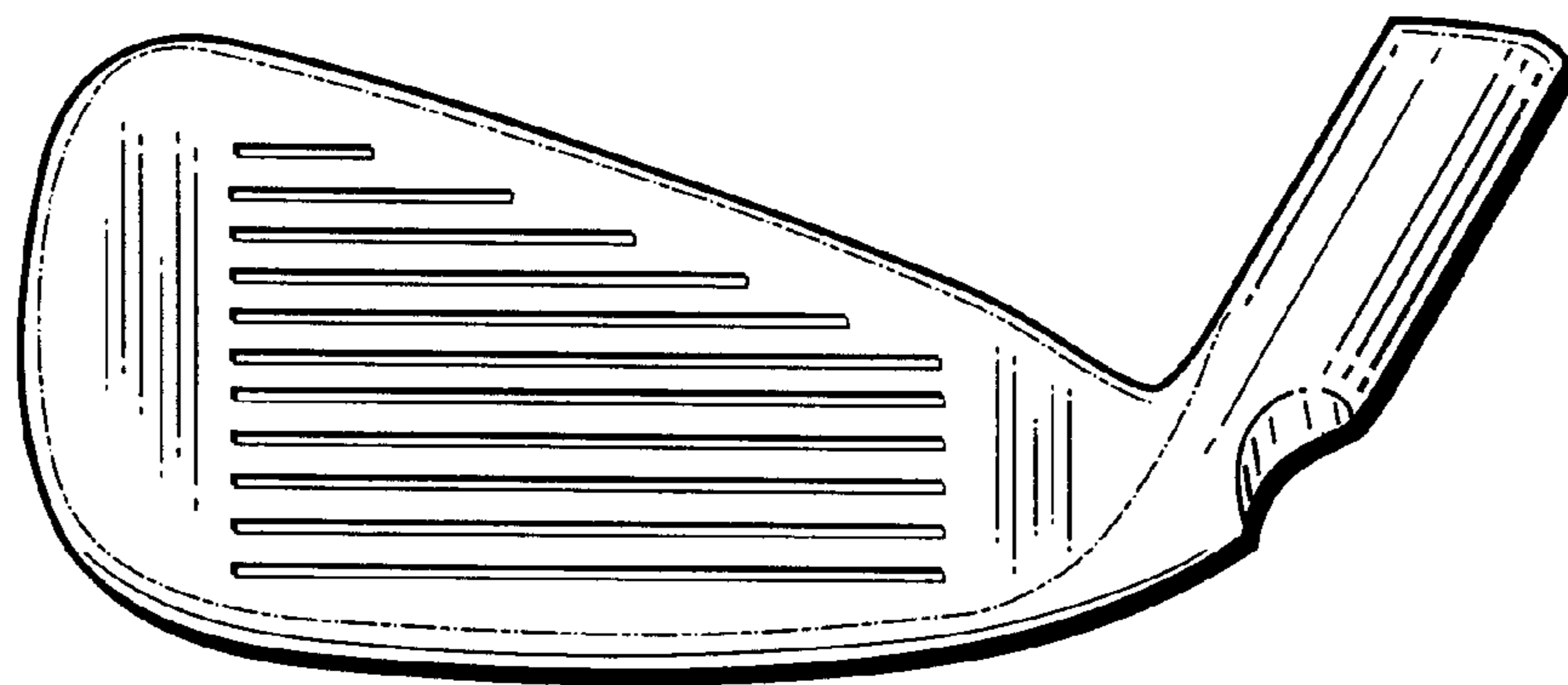
*Fig. 3*



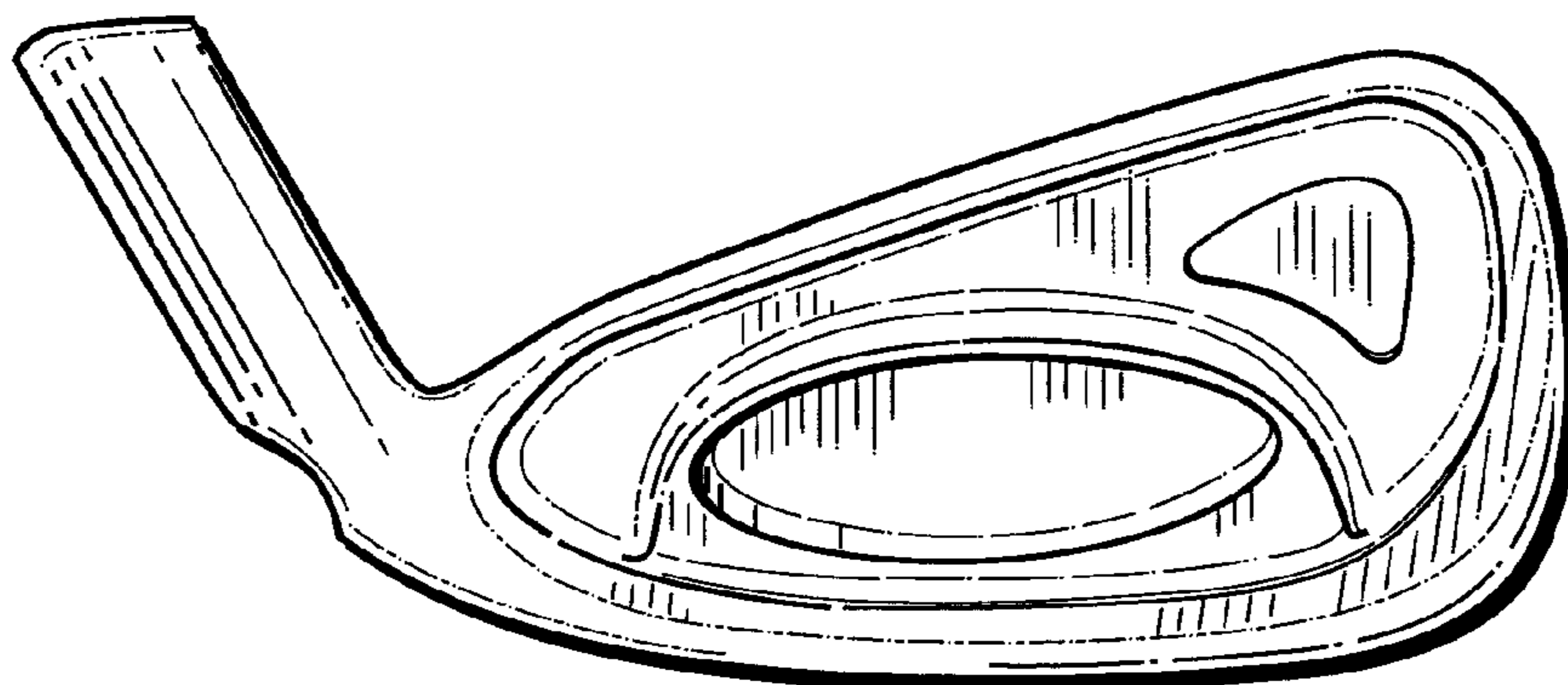
*Fig. 4*



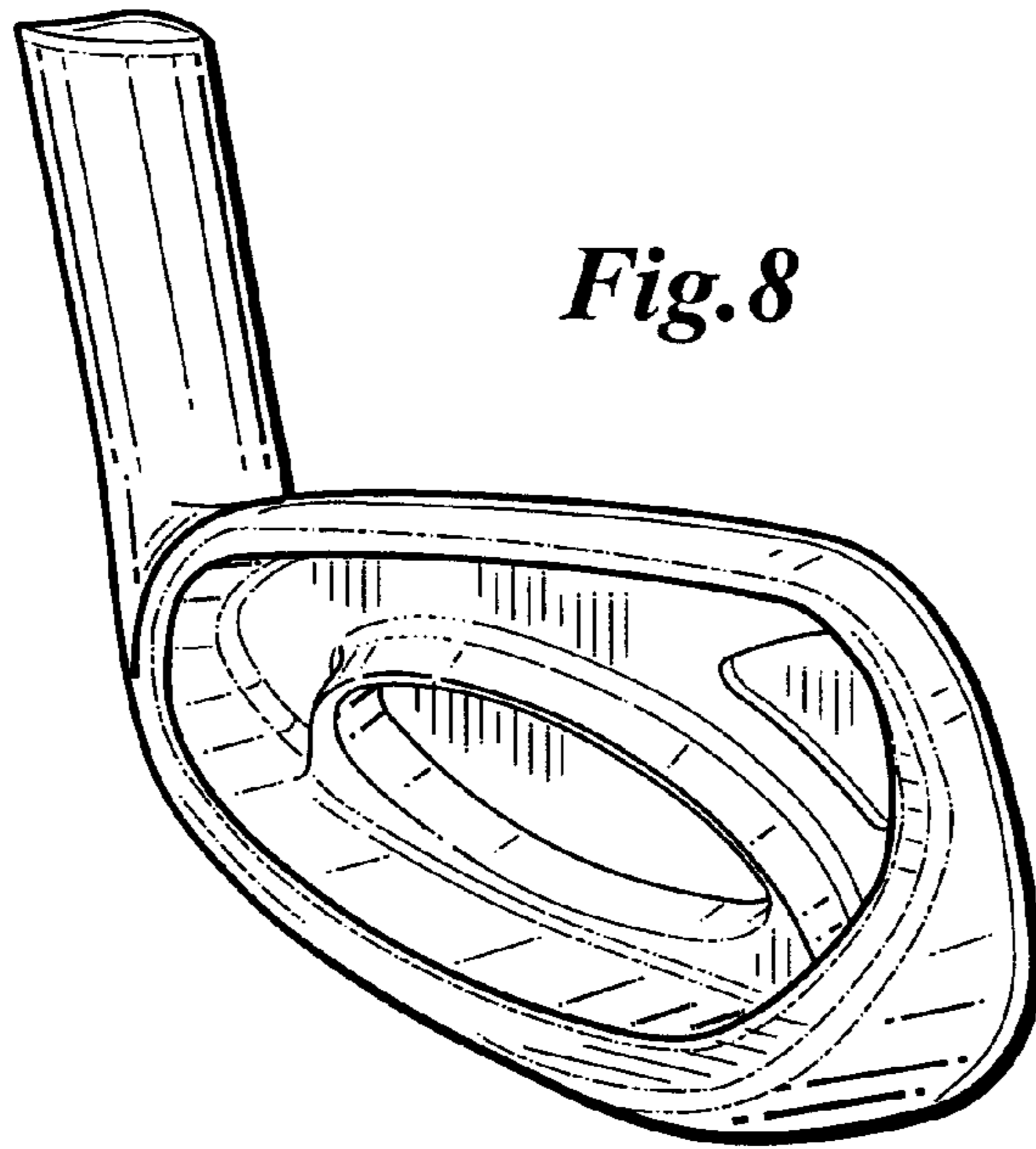
*Fig. 5*



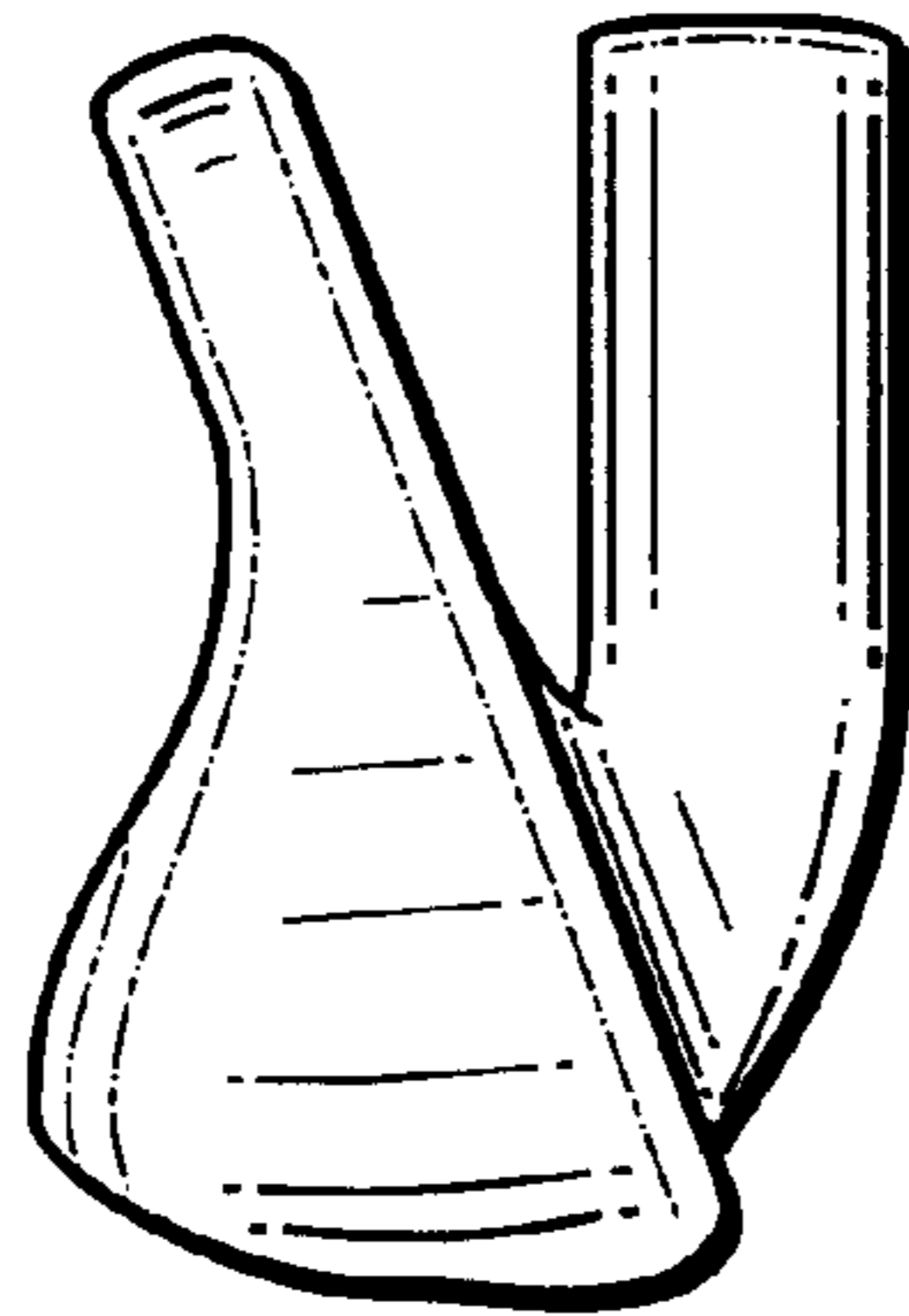
*Fig. 6*



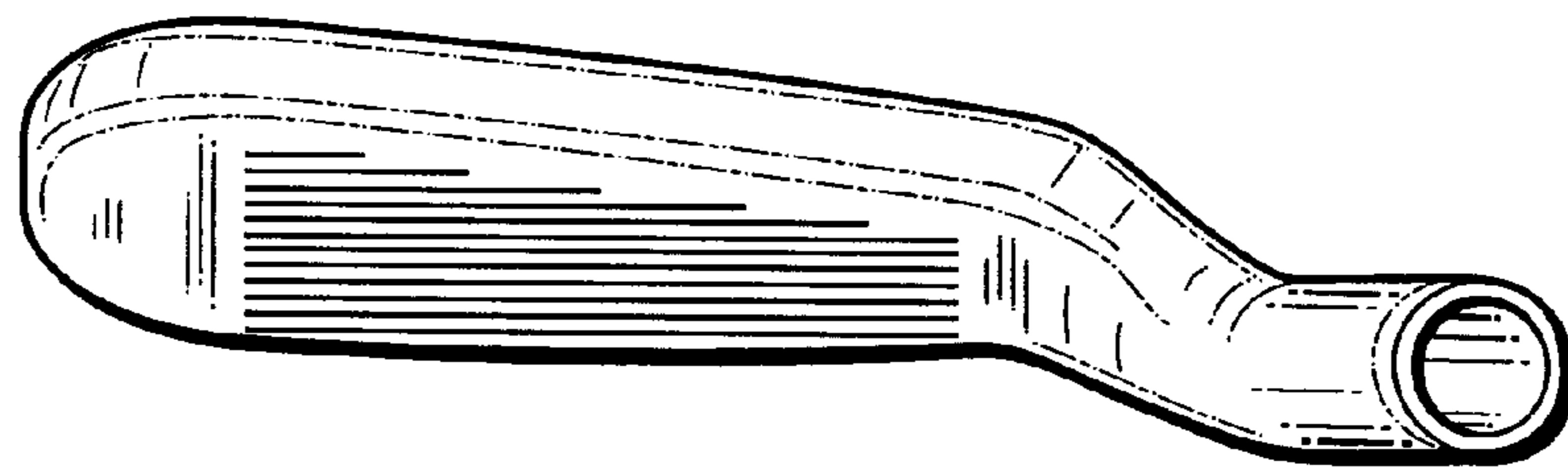
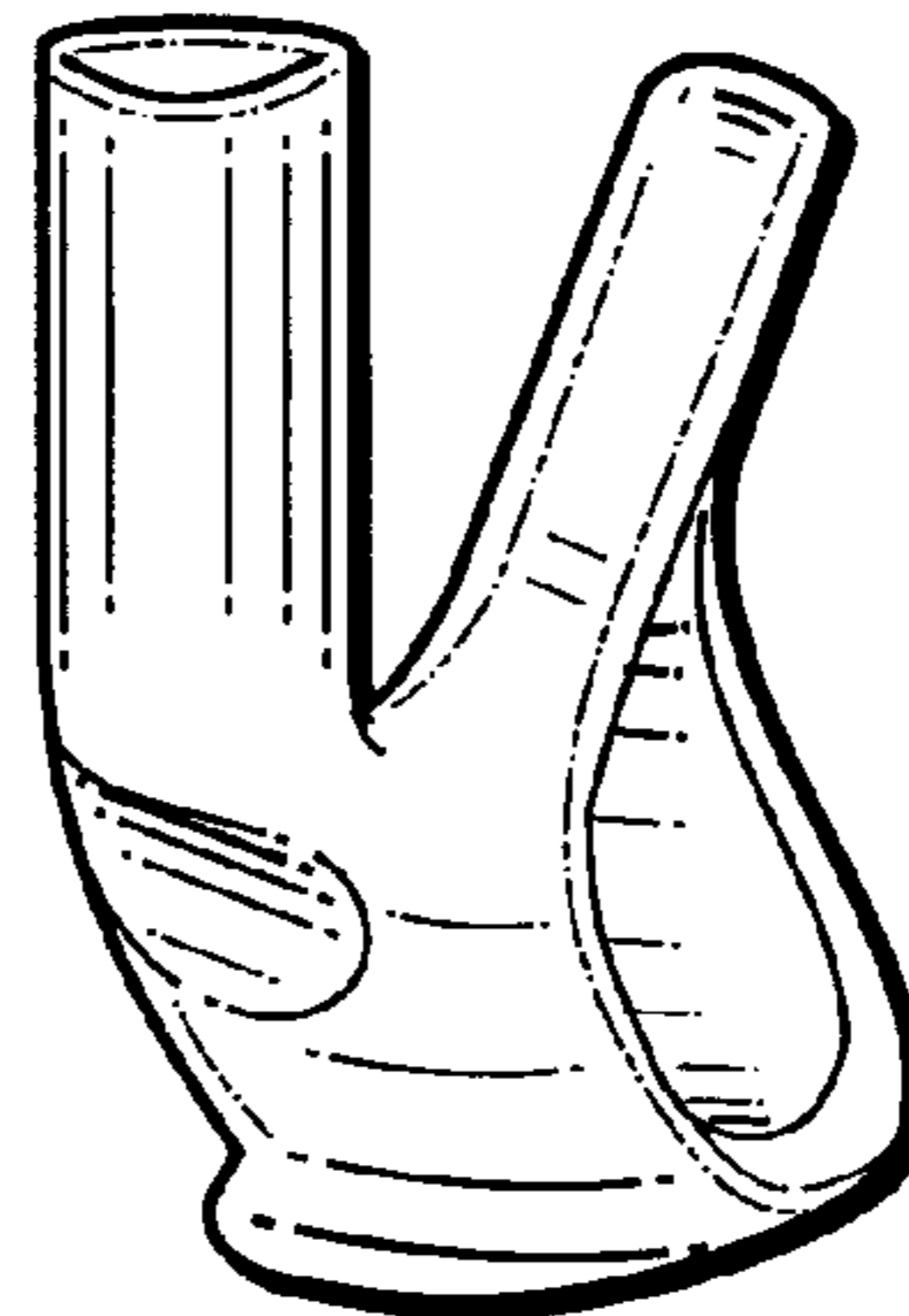
*Fig. 7*

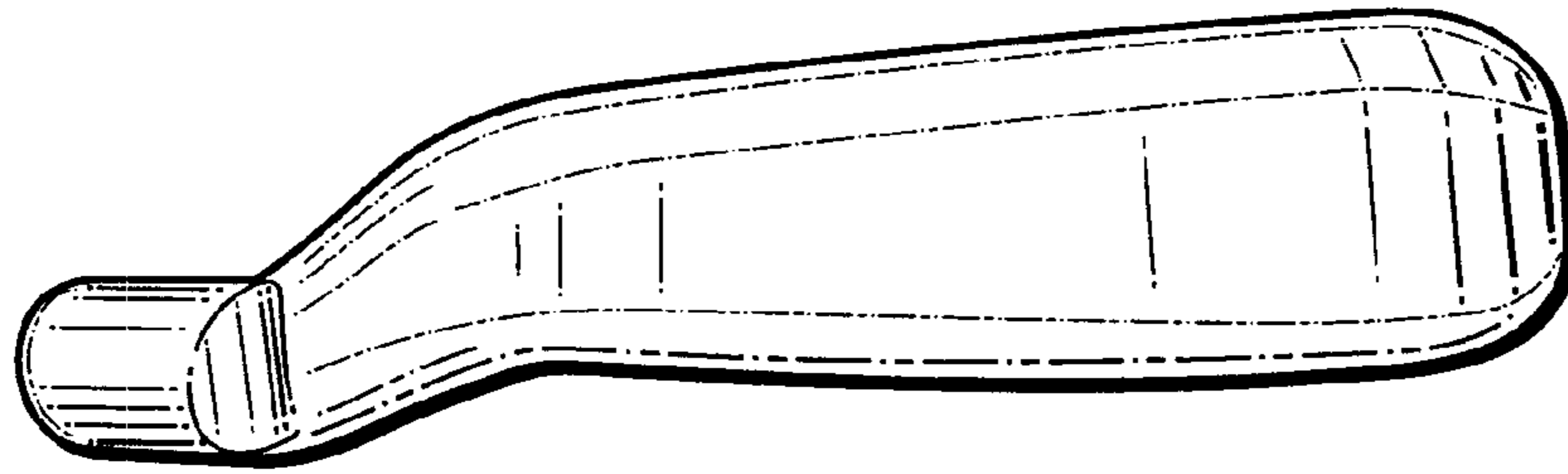


*Fig. 9*

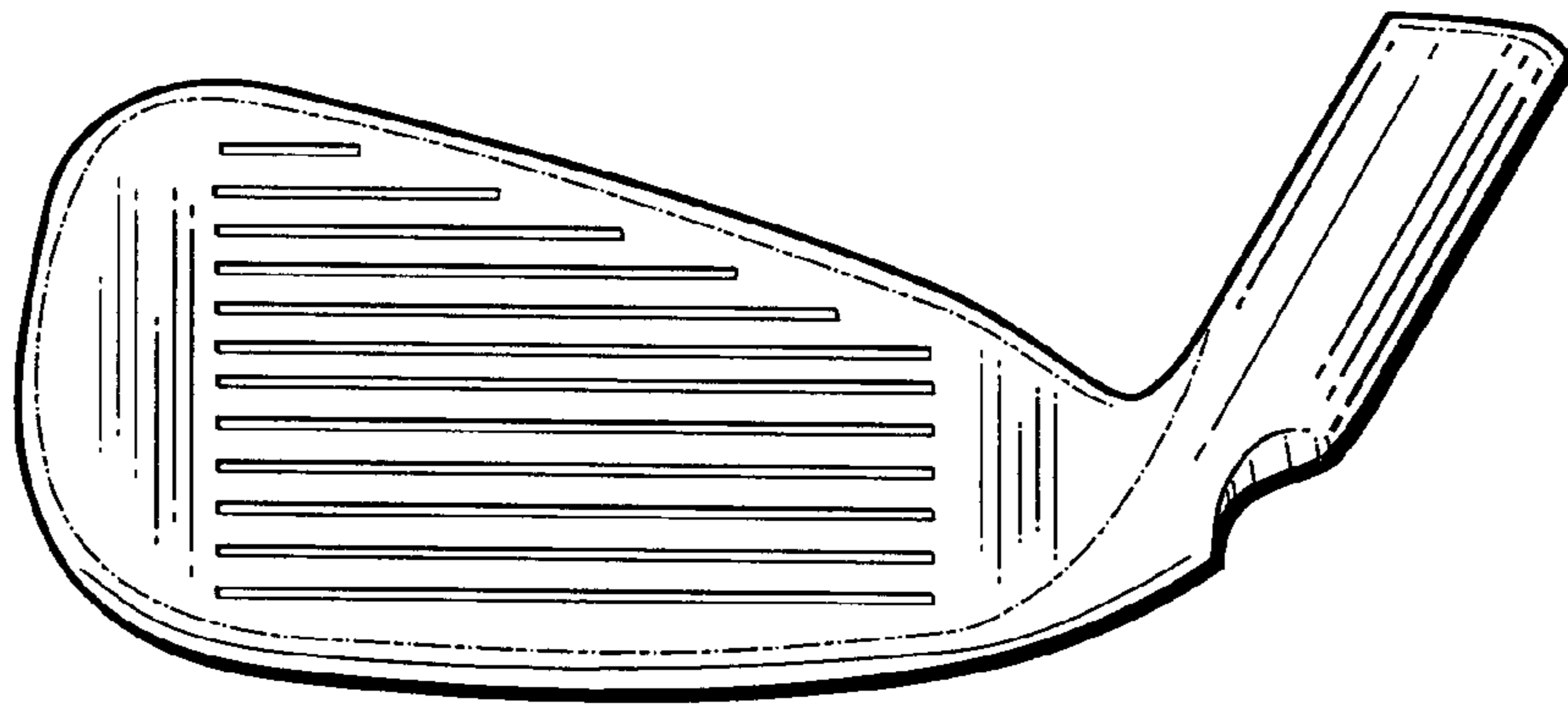


*Fig. 10*

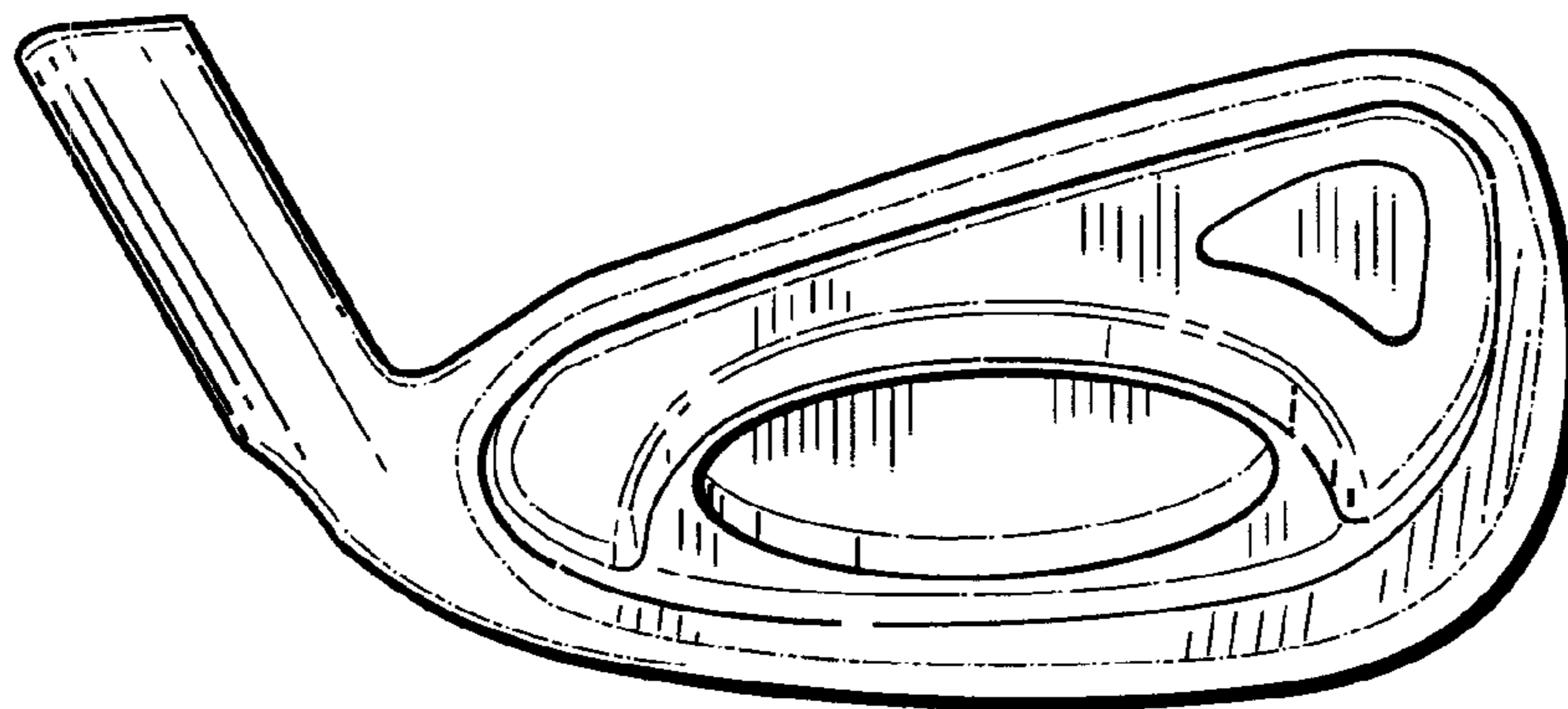




*Fig. 12*



*Fig. 13*



*Fig. 14*