



US00D530759S

(12) **United States Design Patent**
Nicolette et al.

(10) **Patent No.:** **US D530,759 S**
(45) **Date of Patent:** **** Oct. 24, 2006**

(54) **GOLF IRON HEAD**

D502,975 S 3/2005 Schweigert
D508,099 S * 8/2005 Schweigert et al. D21/749

(75) Inventors: **Michael R. Nicolette**, Scottsdale, AZ (US); **Bradley D. Schweigert**, Anthem, AZ (US); **Marty R. Jertson**, Phoenix, AZ (US); **John A. Solheim**, Phoenix, AZ (US); **Eric V. Cole**, Phoenix, AZ (US)

* cited by examiner

Primary Examiner—Mitchell Siegel
(74) *Attorney, Agent, or Firm*—Darrell F. Marquette

(73) Assignee: **Karsten Manufacturing Corporation**, Phoenix, AZ (US)

(57) **CLAIM**

The ornamental design for a golf iron head, as shown and described.

(**) Term: **14 Years**

DESCRIPTION

(21) Appl. No.: **29/230,784**

(22) Filed: **May 25, 2005**

(51) **LOC (8) Cl.** **21-02**

(52) **U.S. Cl.** **D21/749**

(58) **Field of Classification Search** D21/747–751;
473/324–331, 350

See application file for complete search history.

FIG. 1 is a perspective view of a golf iron head with a low loft angle such as a 2-iron showing our new design; FIG. 2 is a toe end view of the golf iron head of FIG. 1; FIG. 3 is a heel end view of the golf iron head of FIG. 1; FIG. 4 is a top view of the golf iron head of FIG. 1; FIG. 5 is a bottom view of the golf iron head of FIG. 1; FIG. 6 is a front elevational view of the golf iron head of FIG. 1; FIG. 7 is a rear elevational view of the golf iron head of FIG. 1; FIG. 8 is a perspective view of a golf iron head with a medium loft angle such as a 5-iron showing our new design; FIG. 9 is a toe end view of the golf iron head of FIG. 8; FIG. 10 is a toe end view of the golf iron head of FIG. 8; FIG. 11 is a top view of the golf iron head of FIG. 8; FIG. 12 is a bottom view of the golf iron head of FIG. 8; FIG. 13 is a front elevational view of the golf iron head of FIG. 8; and, FIG. 14 is a rear elevational view of the golf iron head of FIG. 8.

(56) **References Cited**

U.S. PATENT DOCUMENTS

D256,264 S	8/1980	Solheim	
D379,393 S	5/1997	Kubica	
D422,043 S	3/2000	Kubica	
D429,299 S	8/2000	Kubica	
D442,659 S	5/2001	Kubica	
D443,008 S	5/2001	Kubica	
D470,554 S	* 2/2003	Truesdale D21/747
D494,648 S	8/2004	Schweigert	
D500,350 S	12/2004	Schweigert	
D502,237 S	2/2005	Schweigert	

1 Claim, 4 Drawing Sheets

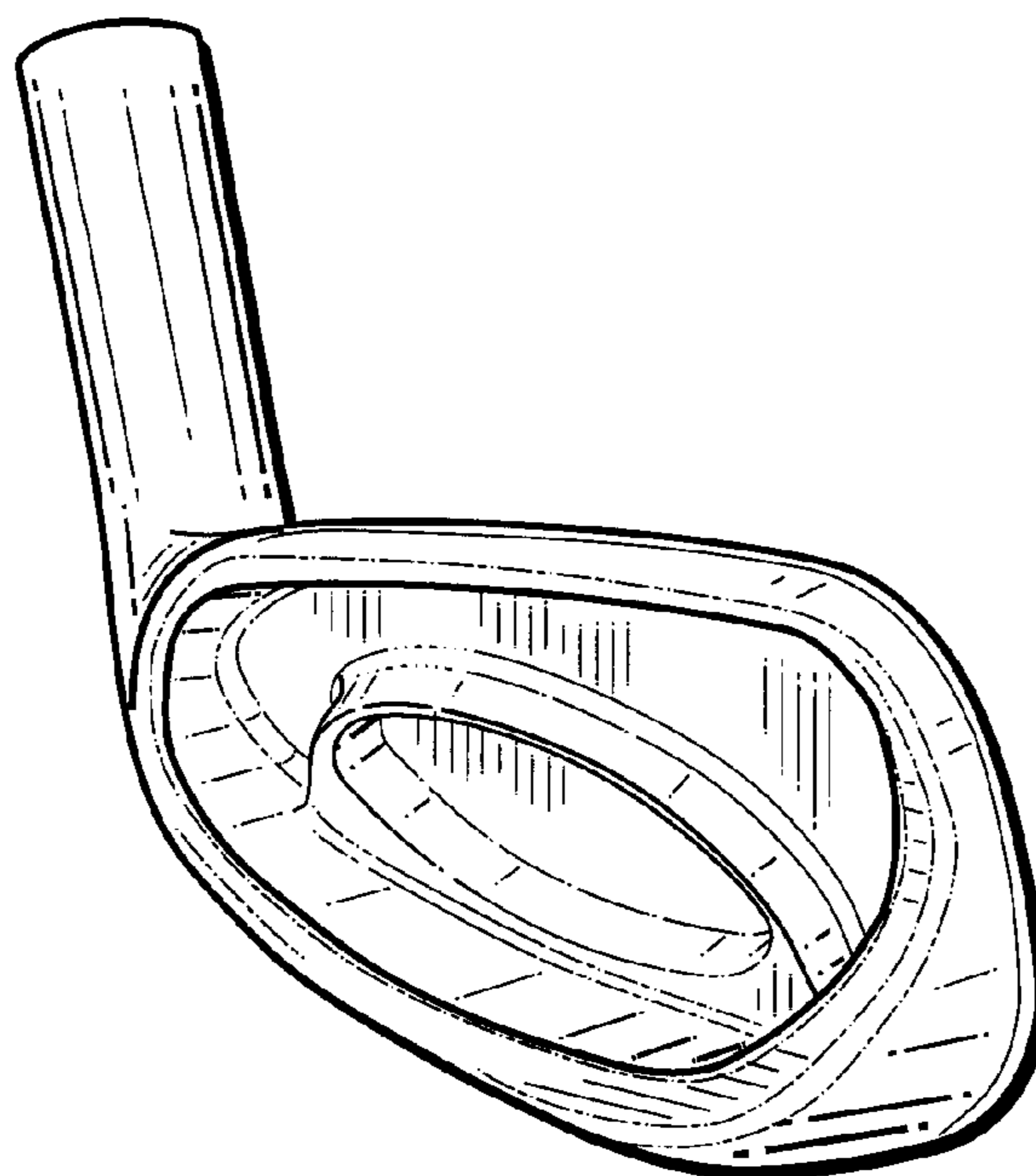

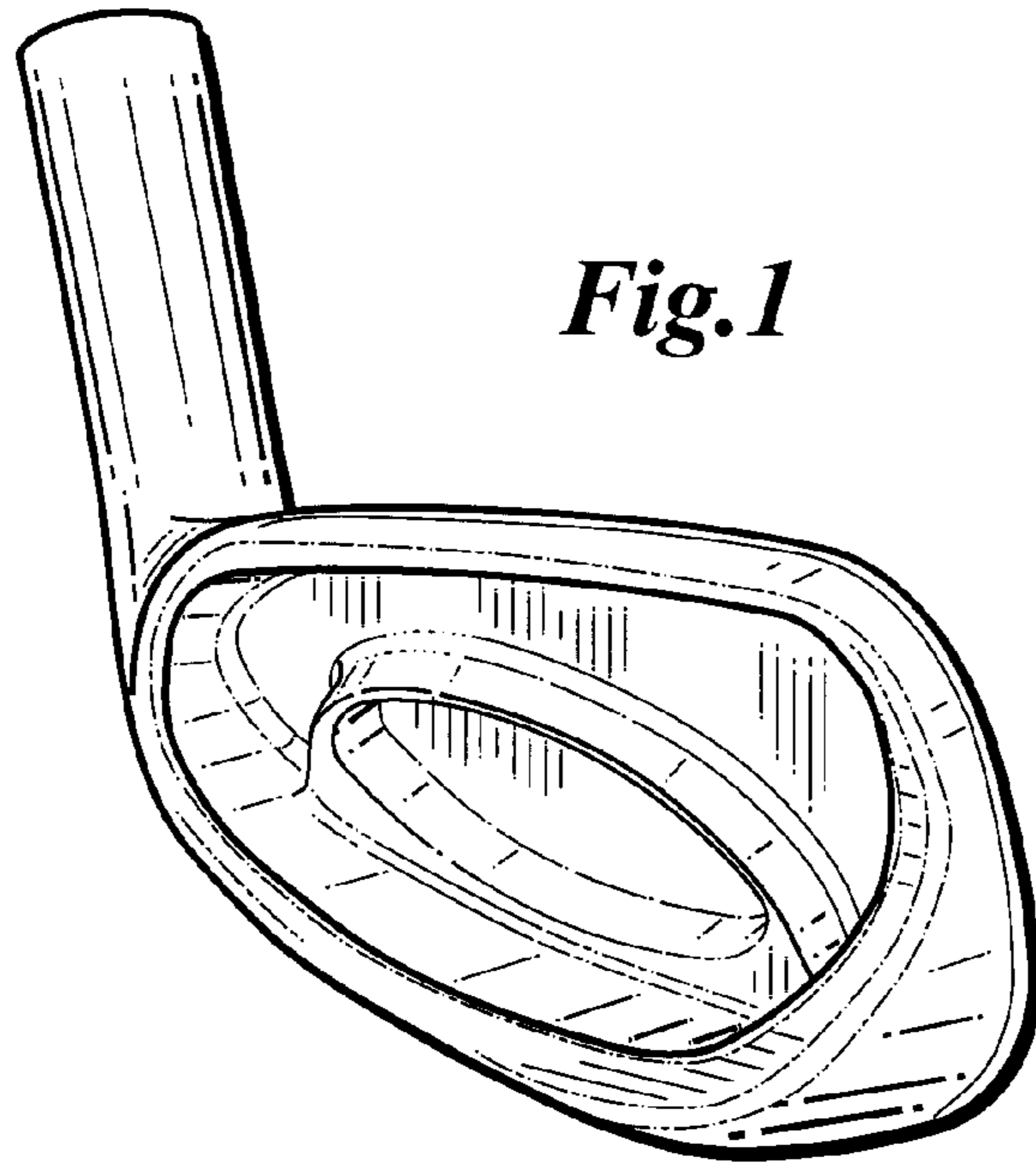

Fig. 2

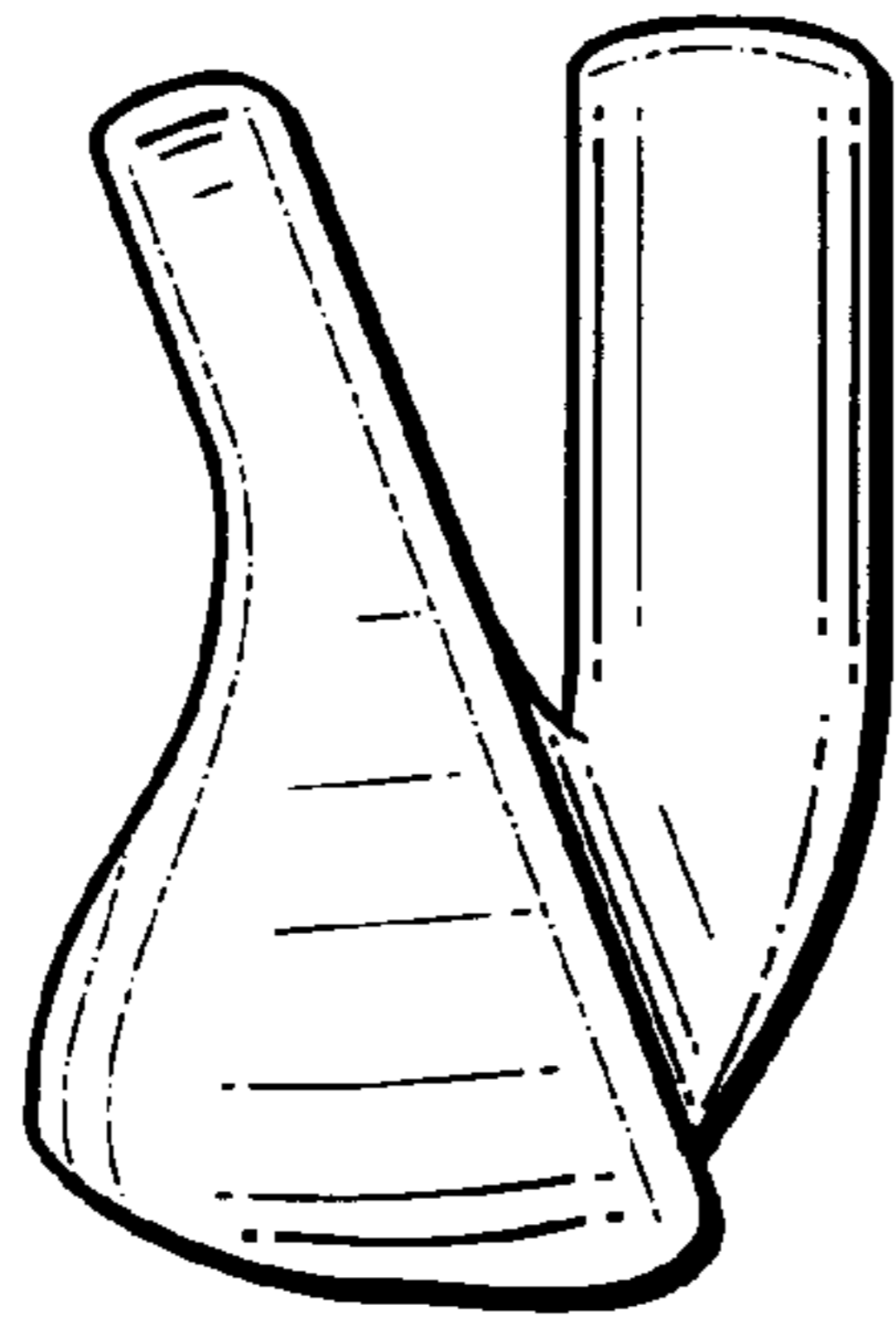
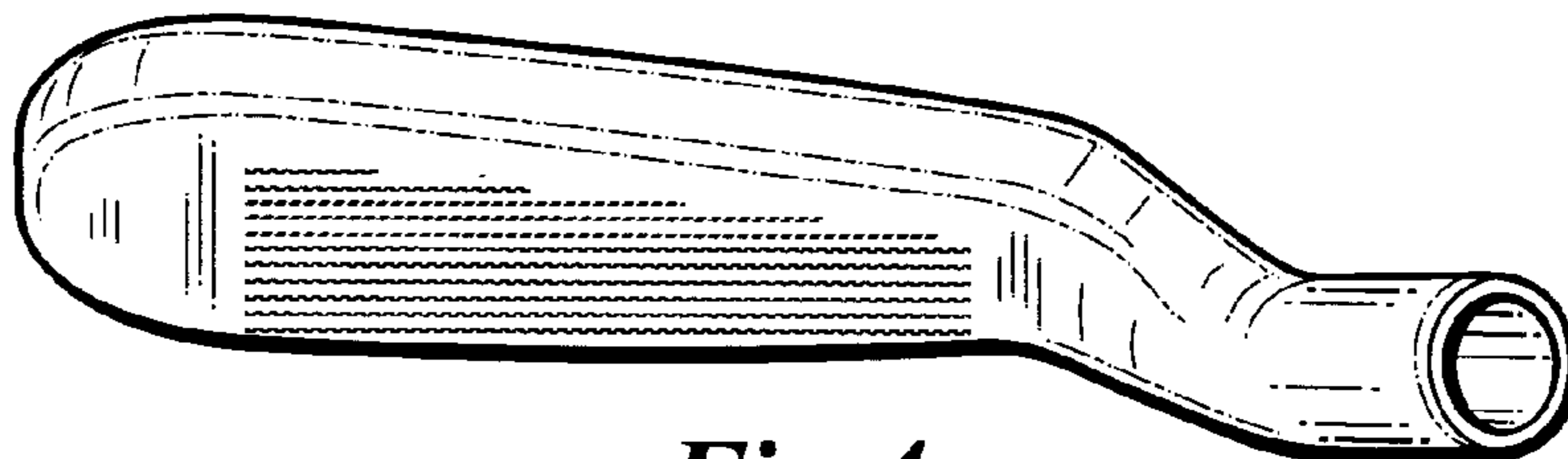
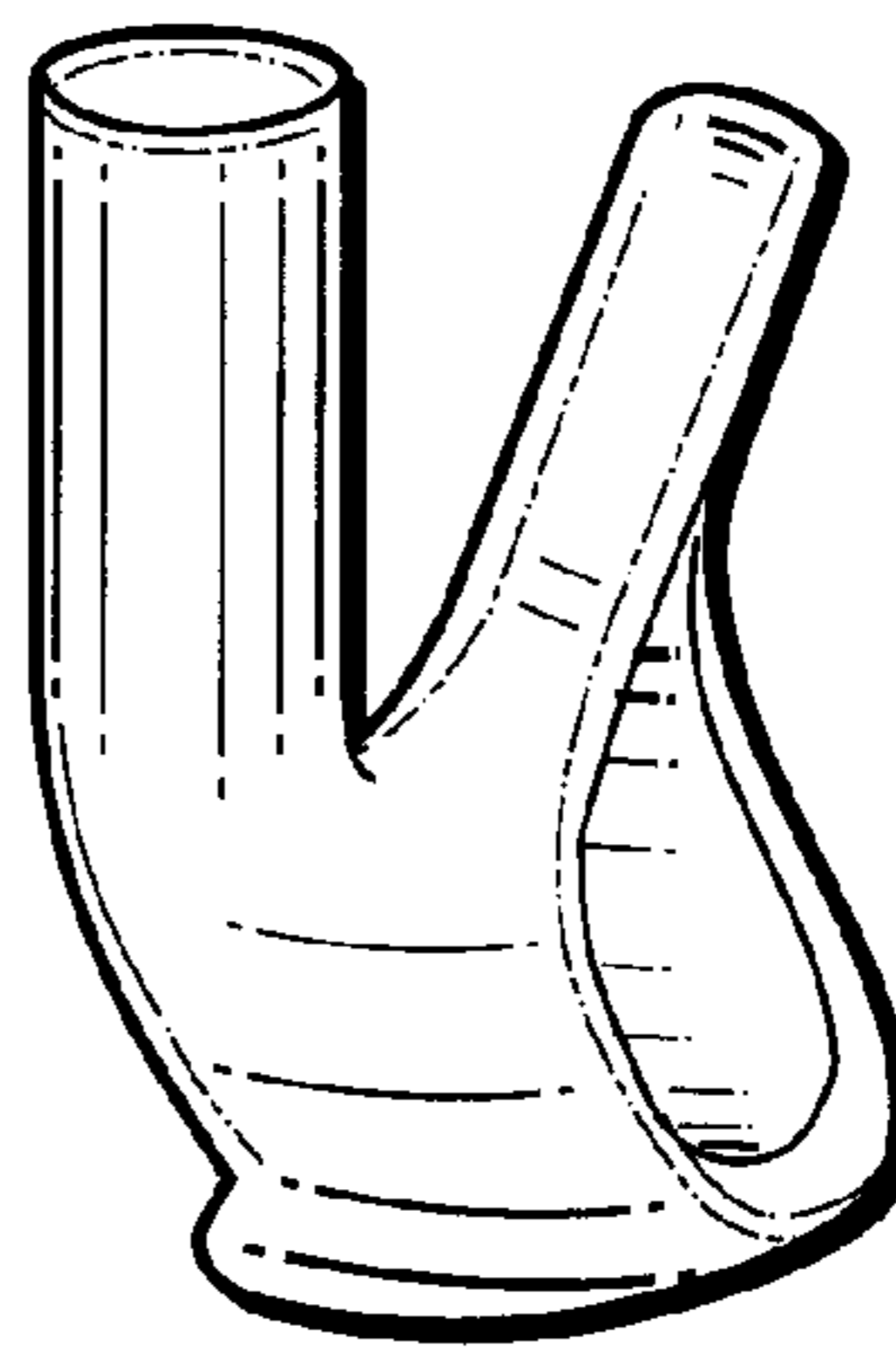

Fig. 3



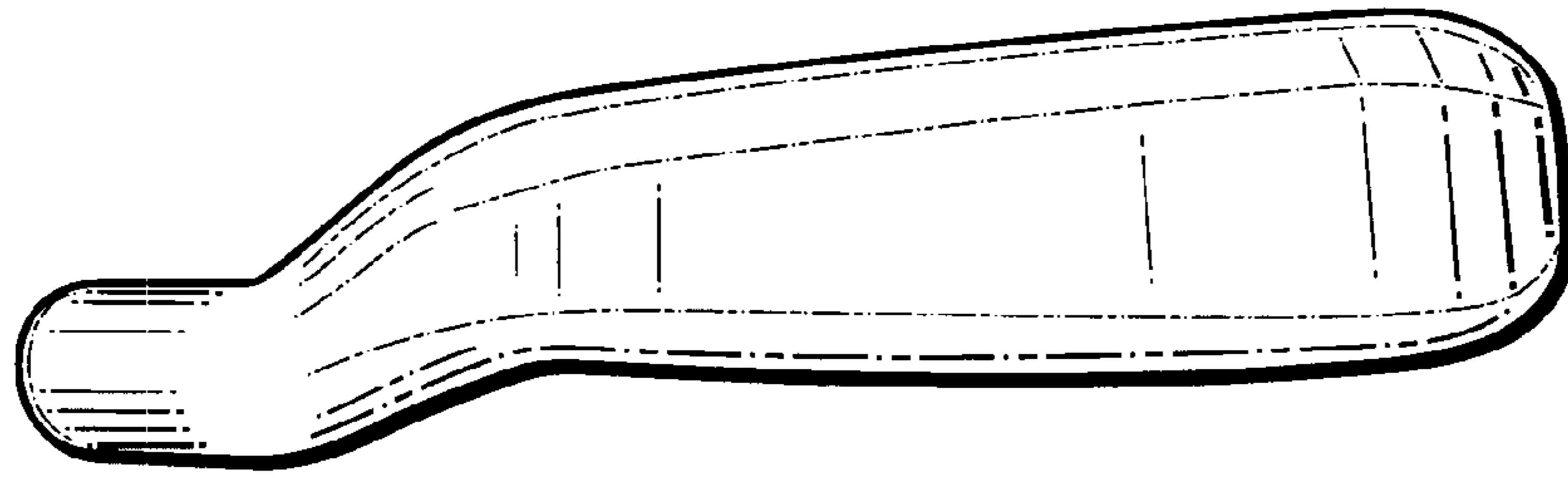

Fig. 5

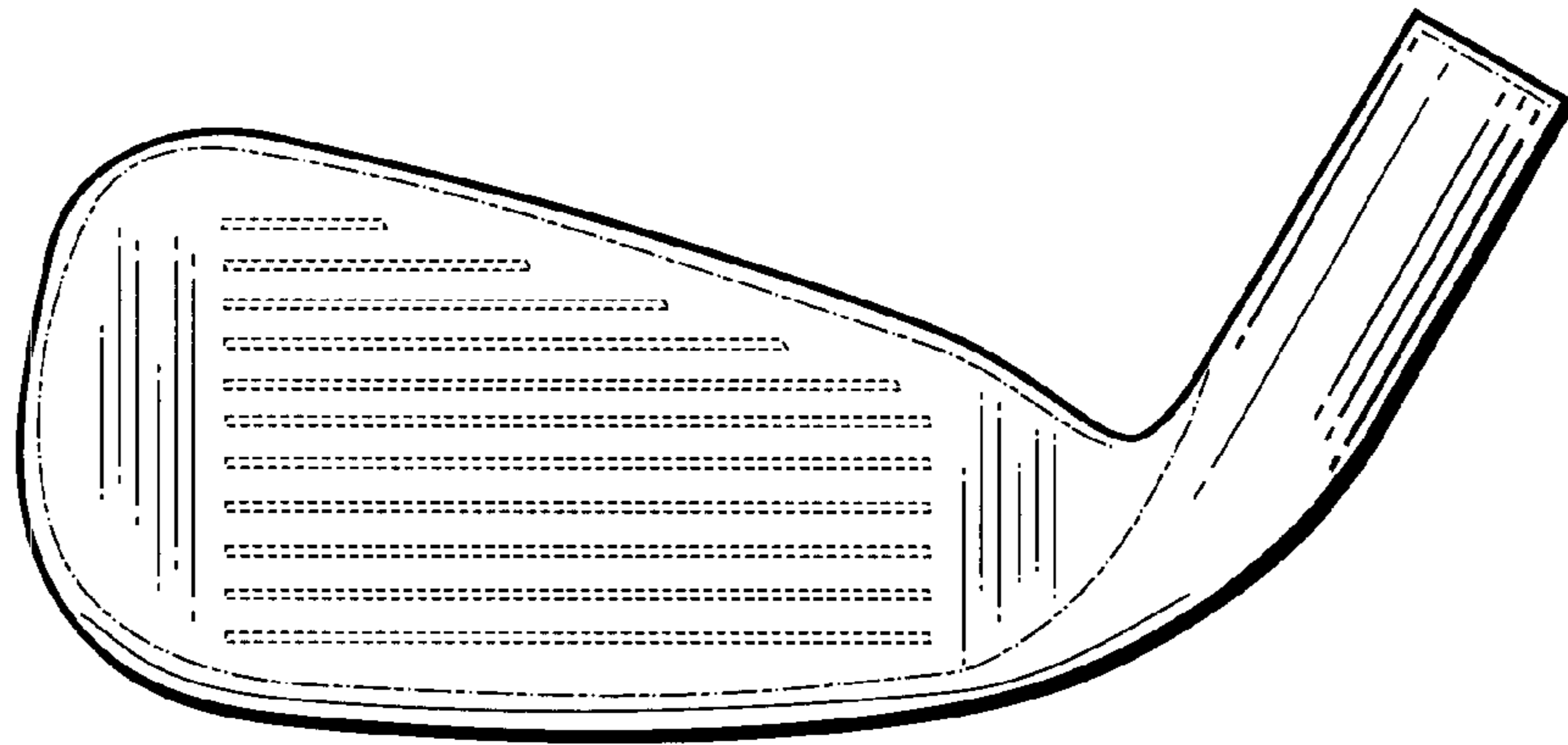

Fig. 6

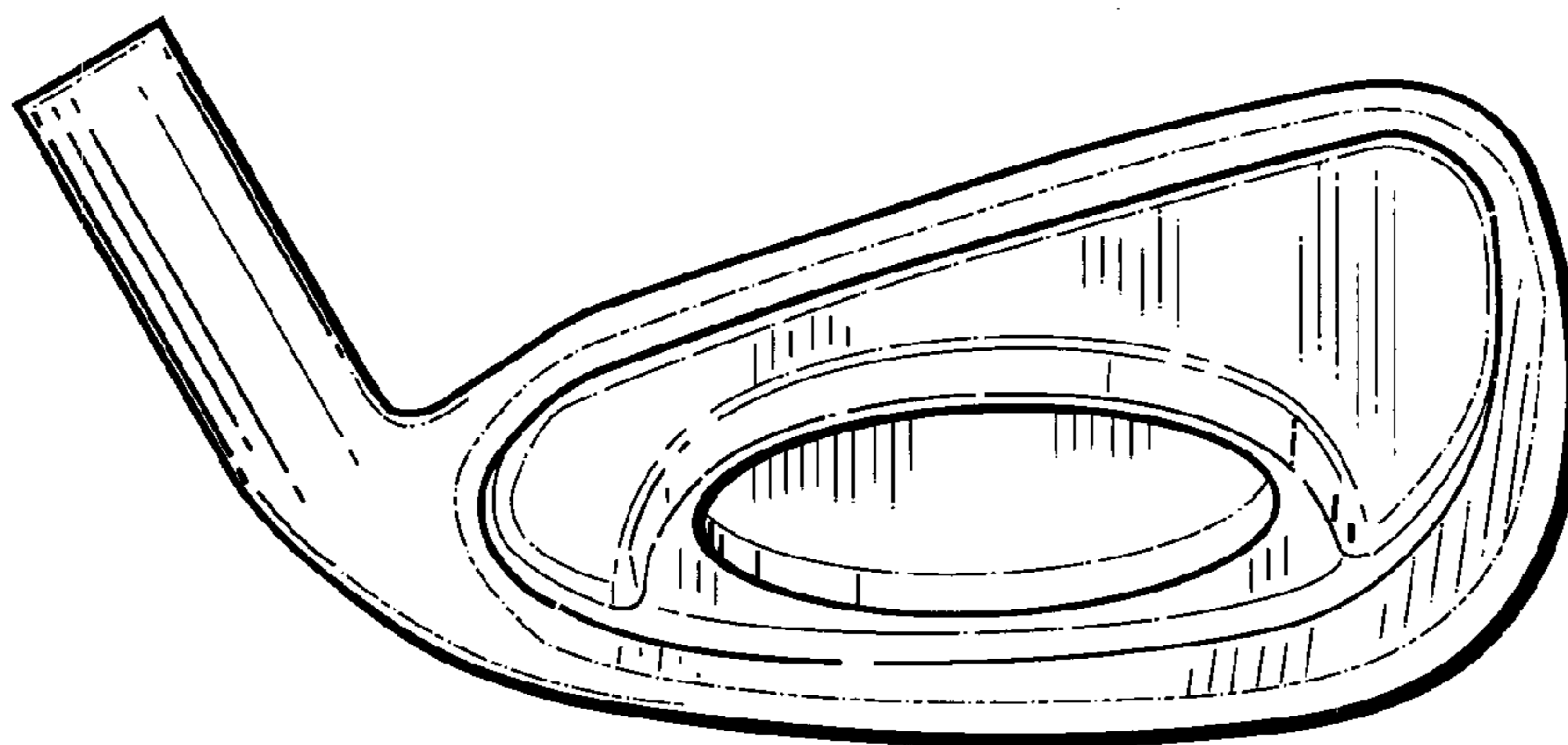

Fig. 7

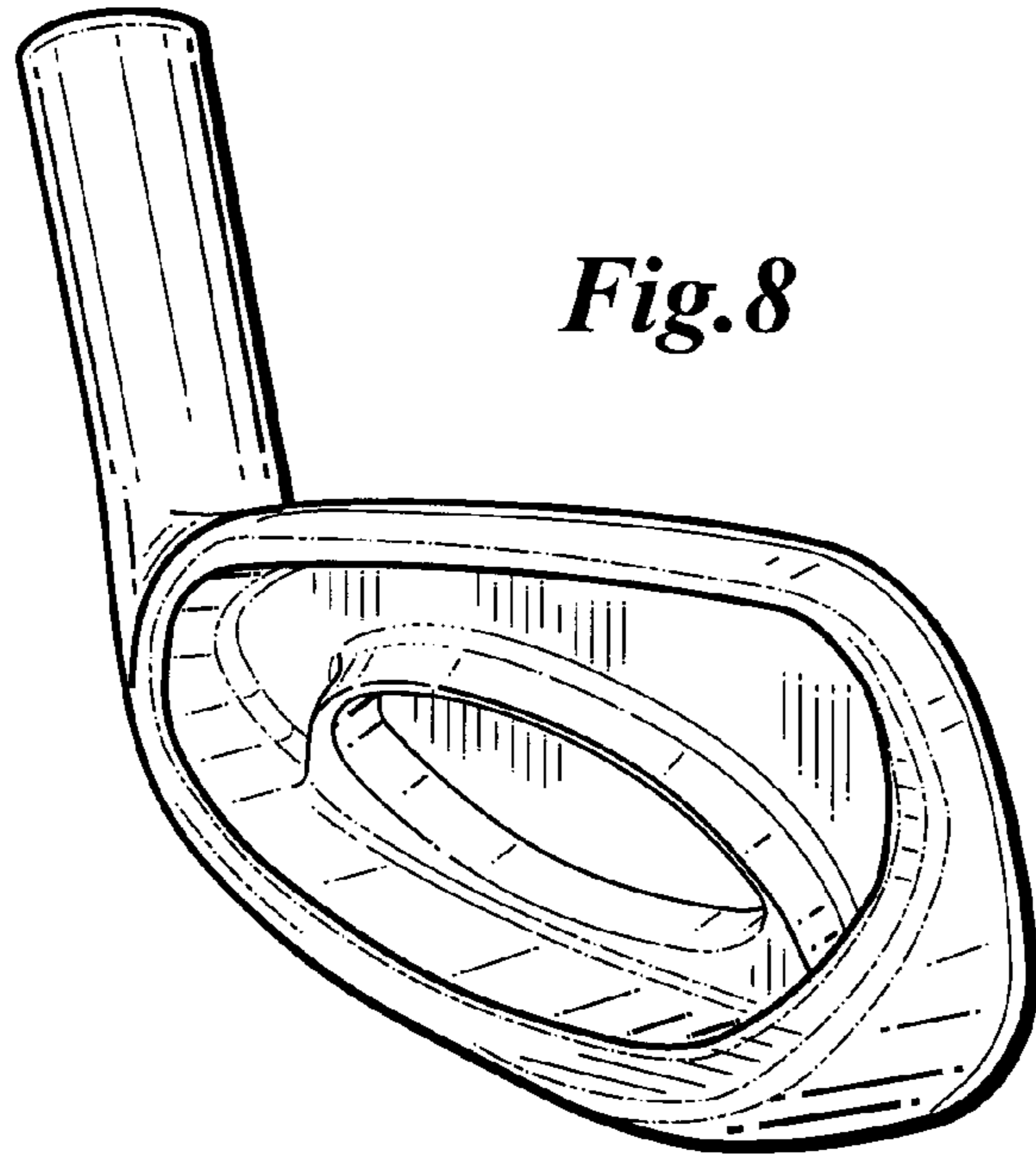

Fig. 9

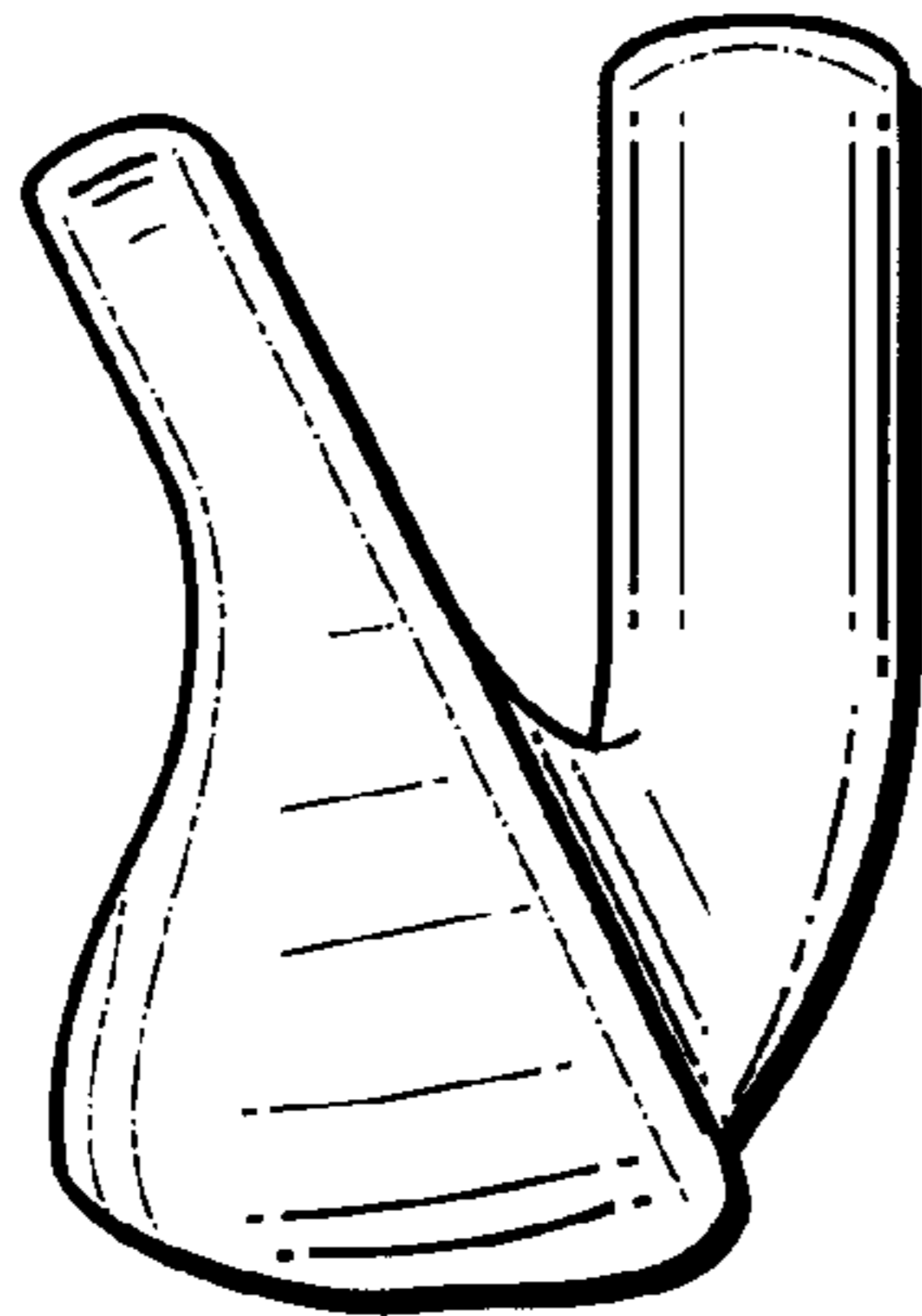

Fig. 10

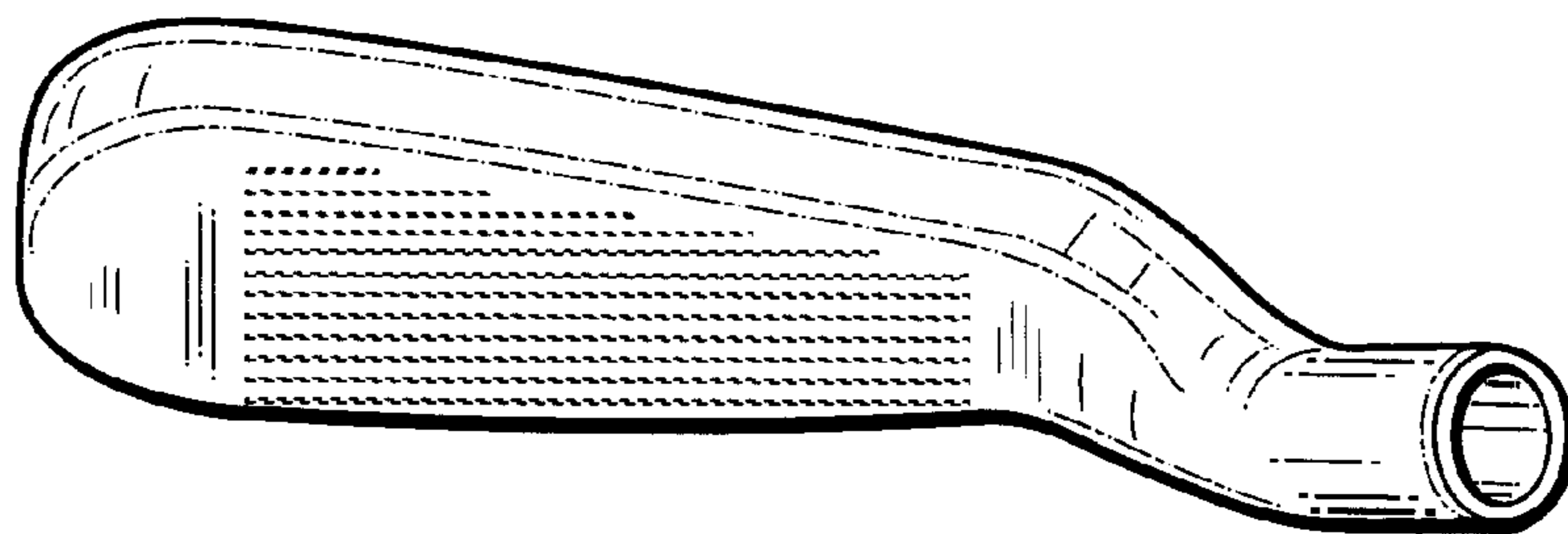
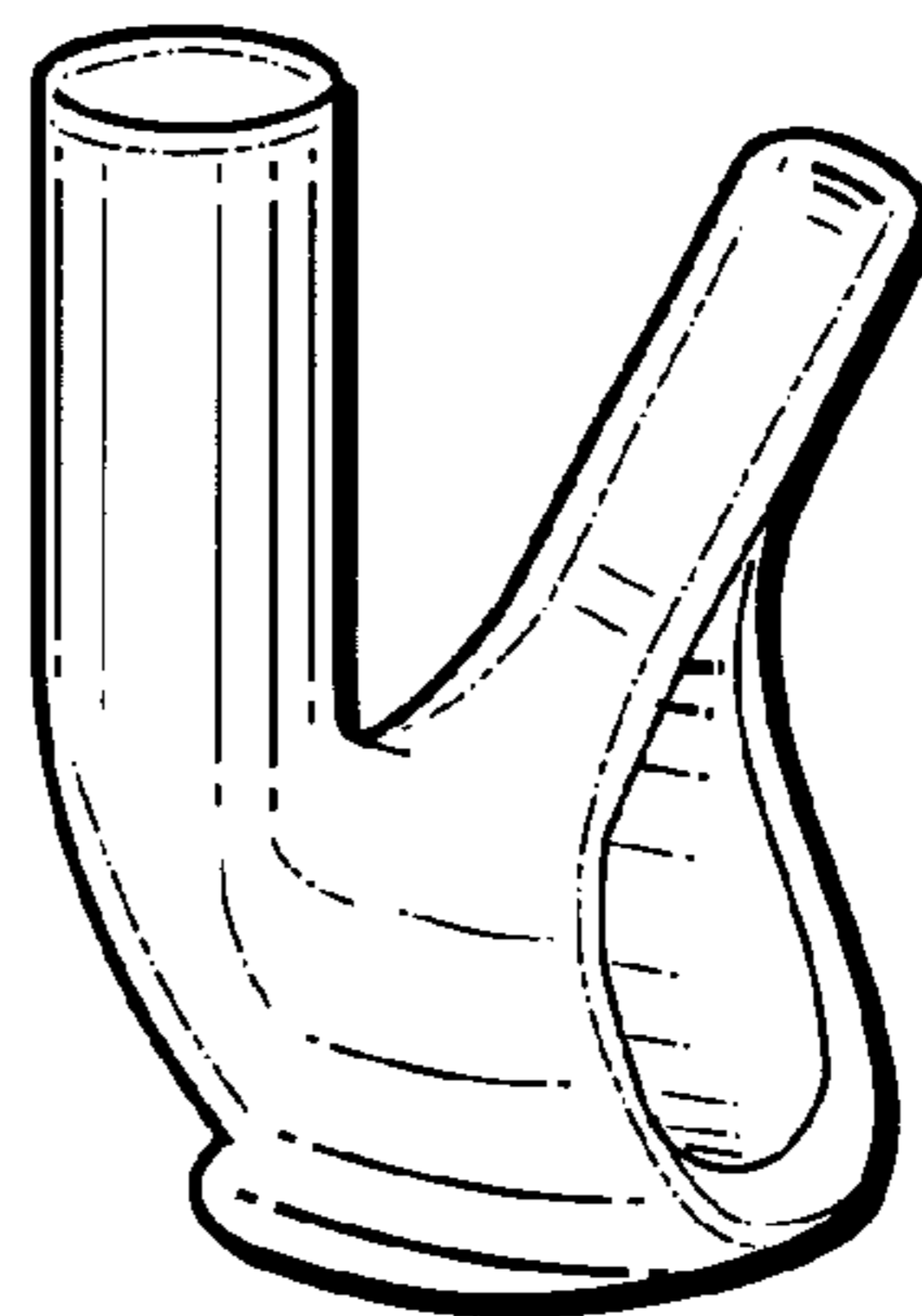

Fig. 11

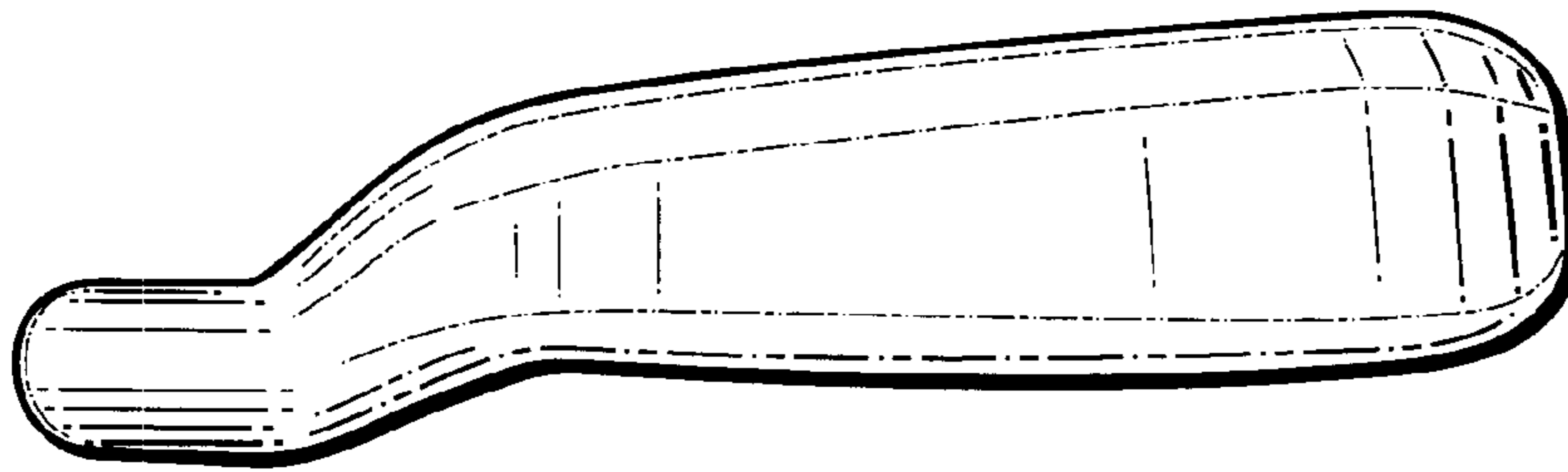

Fig. 12

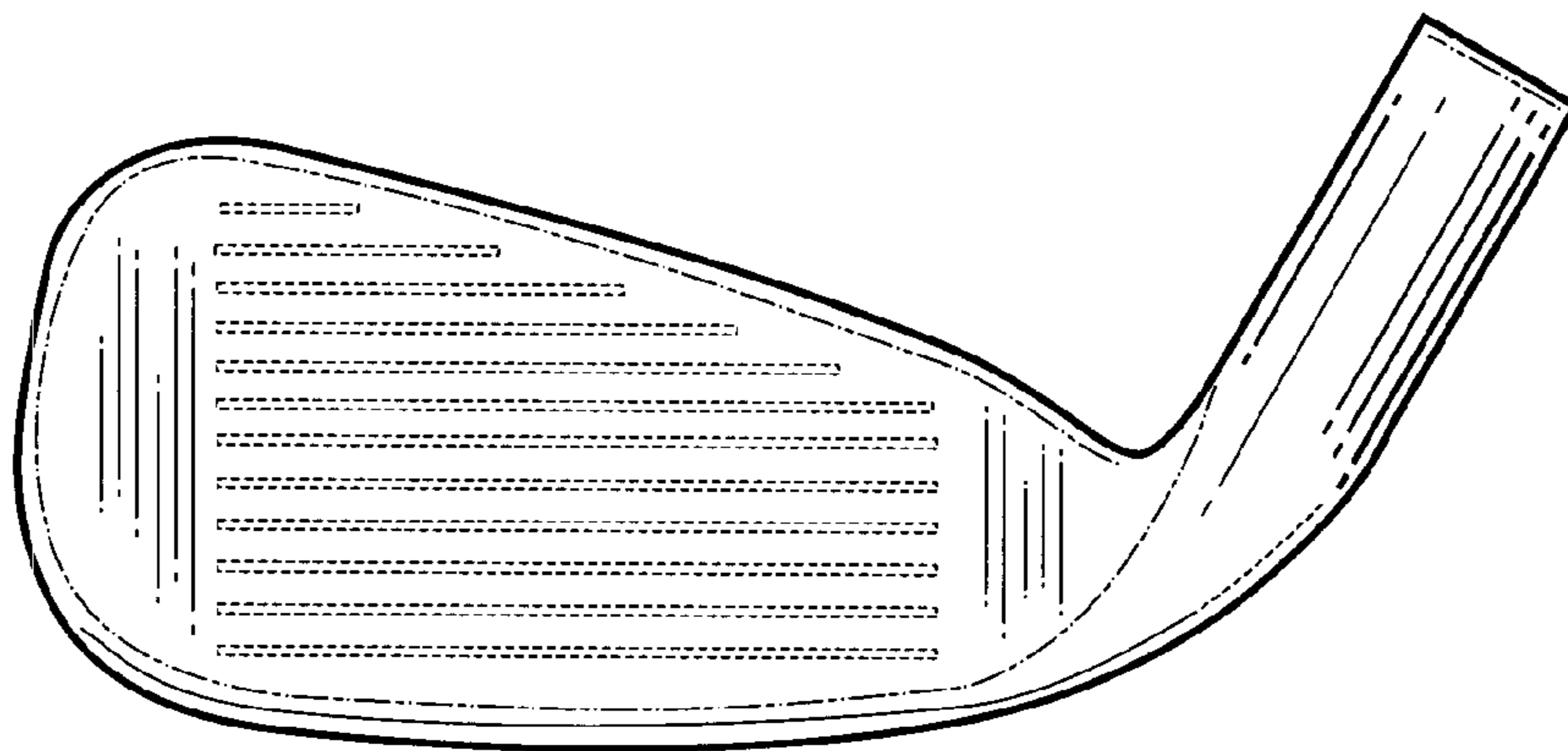

Fig. 13

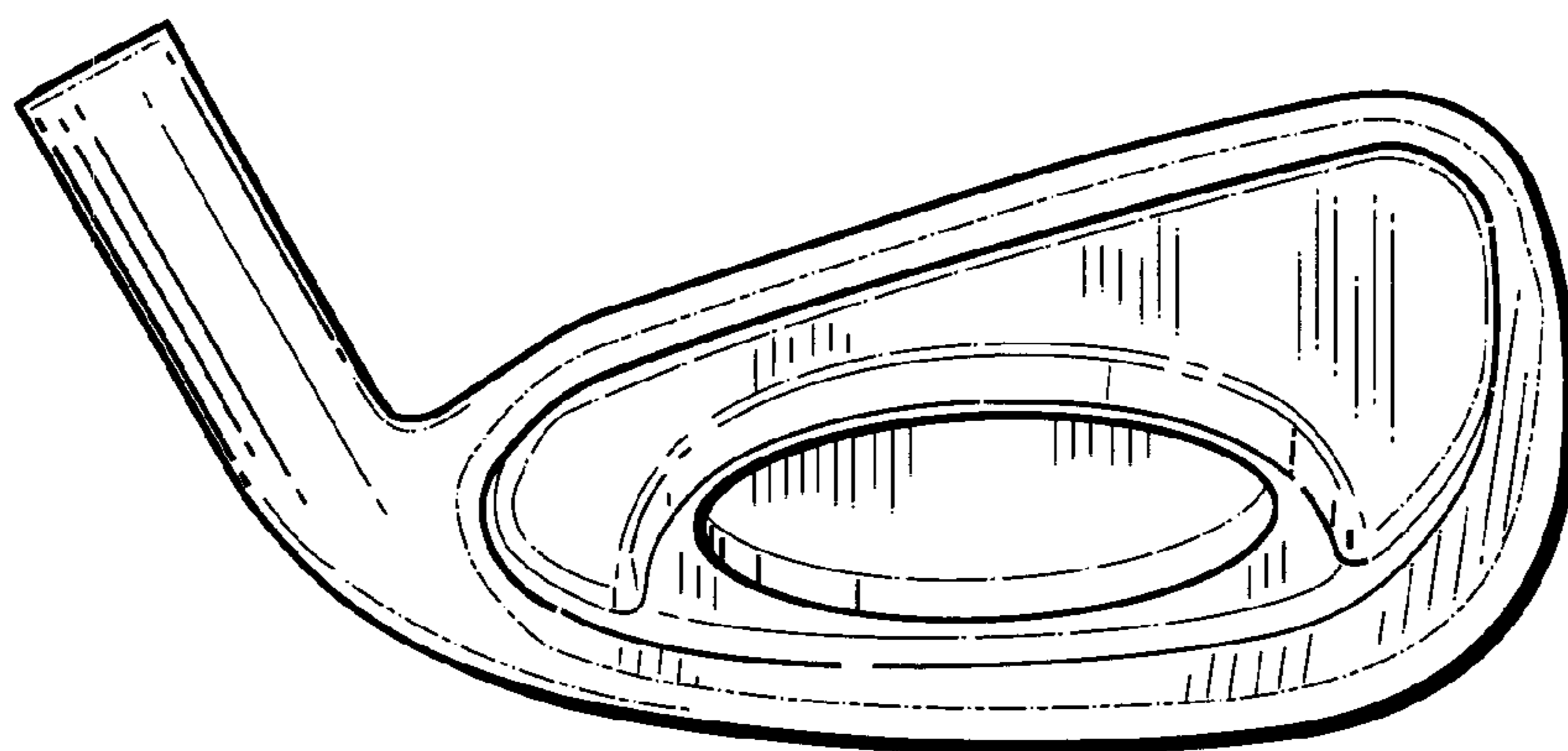

Fig. 14