



US00D530723S

(12) **United States Design Patent**
Huang

(10) **Patent No.:** **US D530,723 S**

(45) **Date of Patent:** **** Oct. 24, 2006**

(54) **COLD AIR BOX OF THE AIR FILTER**

(76) Inventor: **Jui-Fa Huang**, No. 523, Jhanglu Rd.,
Sioushuei Township, Changhua County
504 (TW)

(**) Term: **14 Years**

(21) Appl. No.: **29/234,421**

(22) Filed: **Jul. 19, 2005**

(51) **LOC (8) Cl.** **15-01**

(52) **U.S. Cl.** **D15/5**

(58) **Field of Classification Search** D15/1-9;
D23/355, 364, 365; 123/184.56, 54.6, 41.54,
123/184.21, 184.43, 184.46, 184.47, 184.48,
123/198 E; 180/182; 55/385.1-385.3, 385.7,
55/522

See application file for complete search history.

(56) **References Cited**

U.S. PATENT DOCUMENTS

4,653,439 A * 3/1987 Desai et al. 123/184.31
4,771,679 A * 9/1988 Tsuru 454/146

D472,246 S * 3/2003 Ayton D15/5
D510,741 S * 10/2005 Ogose D15/5
D521,134 S * 5/2006 Huang D23/364
2004/0159482 A1 * 8/2004 Eide 180/182

* cited by examiner

Primary Examiner—Ian Simmons

Assistant Examiner—Maurice Stevens

(74) *Attorney, Agent, or Firm*—Troxell Law Office, PLLC

(57) **CLAIM**

The ornamental design for a cold air box of the air filter, as shown and described.

DESCRIPTION

FIG. 1 is a perspective view of a cold air box of the air filter showing my new design;

FIG. 2 is a front end elevation view thereof;

FIG. 3 is a rear end elevation view thereof;

FIG. 4 is a right side elevation view thereof;

FIG. 5 is a left side elevation view thereof;

FIG. 6 is a top plan view thereof; and,

FIG. 7 is a bottom plan view thereof.

1 Claim, 7 Drawing Sheets

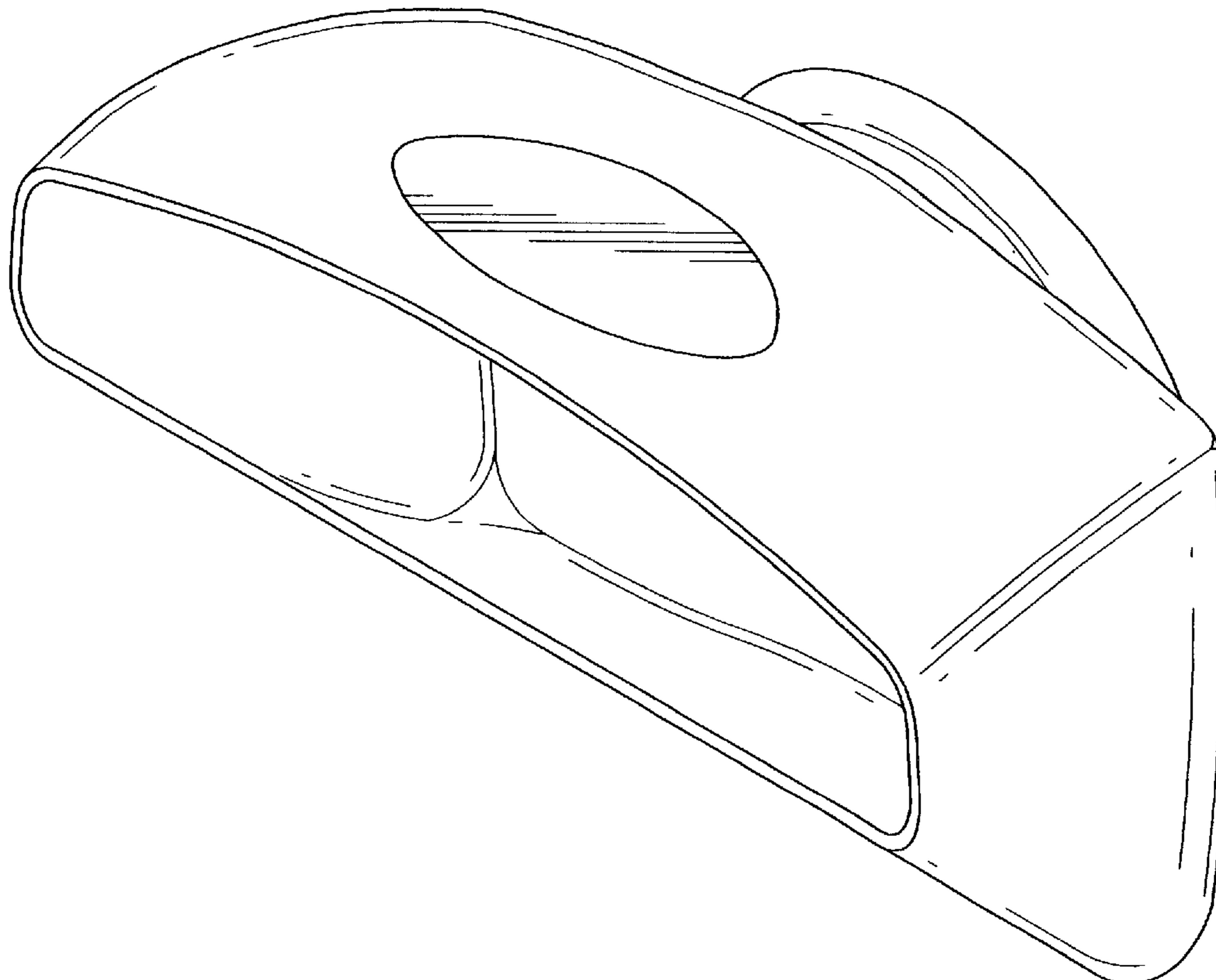

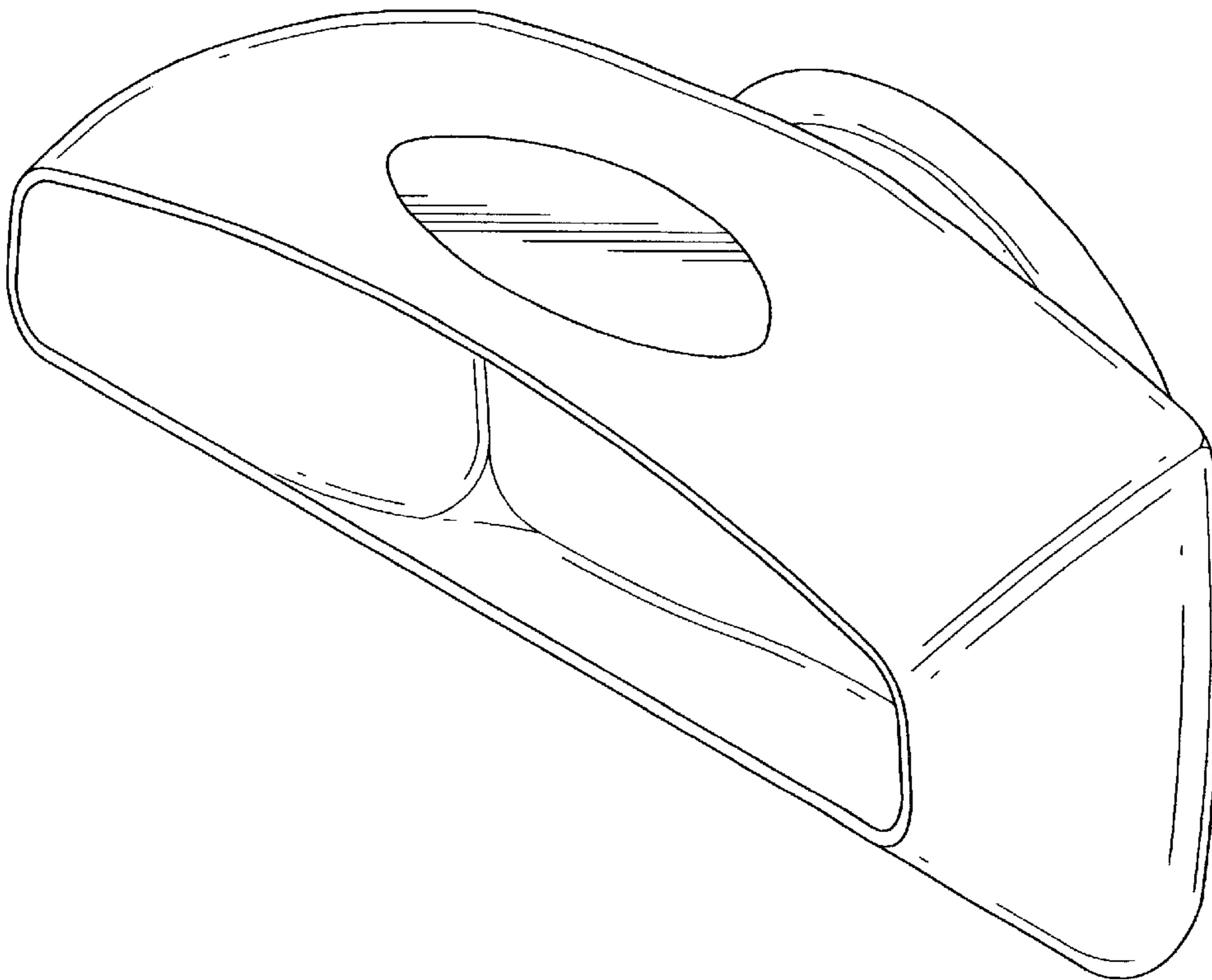

FIG. 1

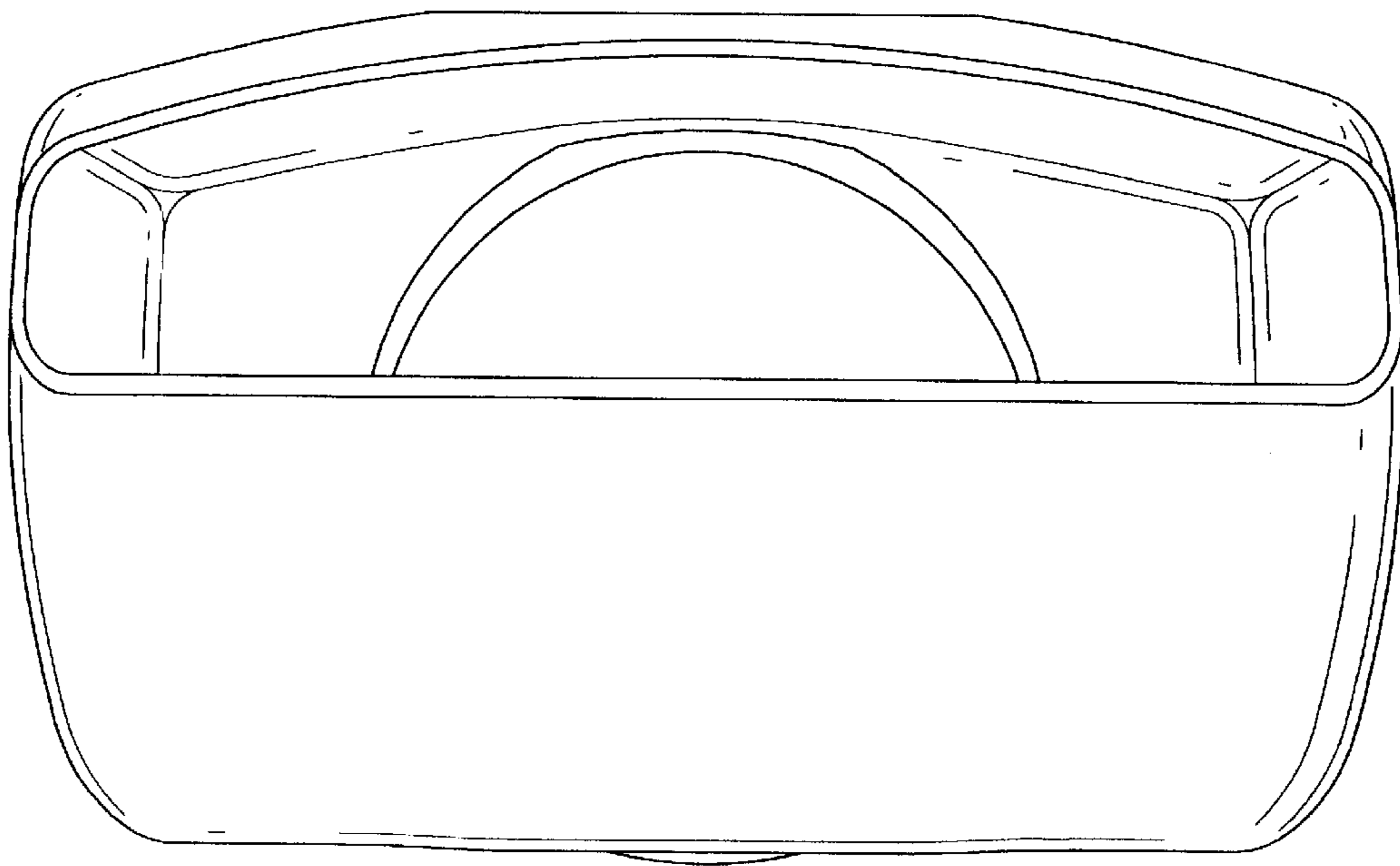

FIG. 2

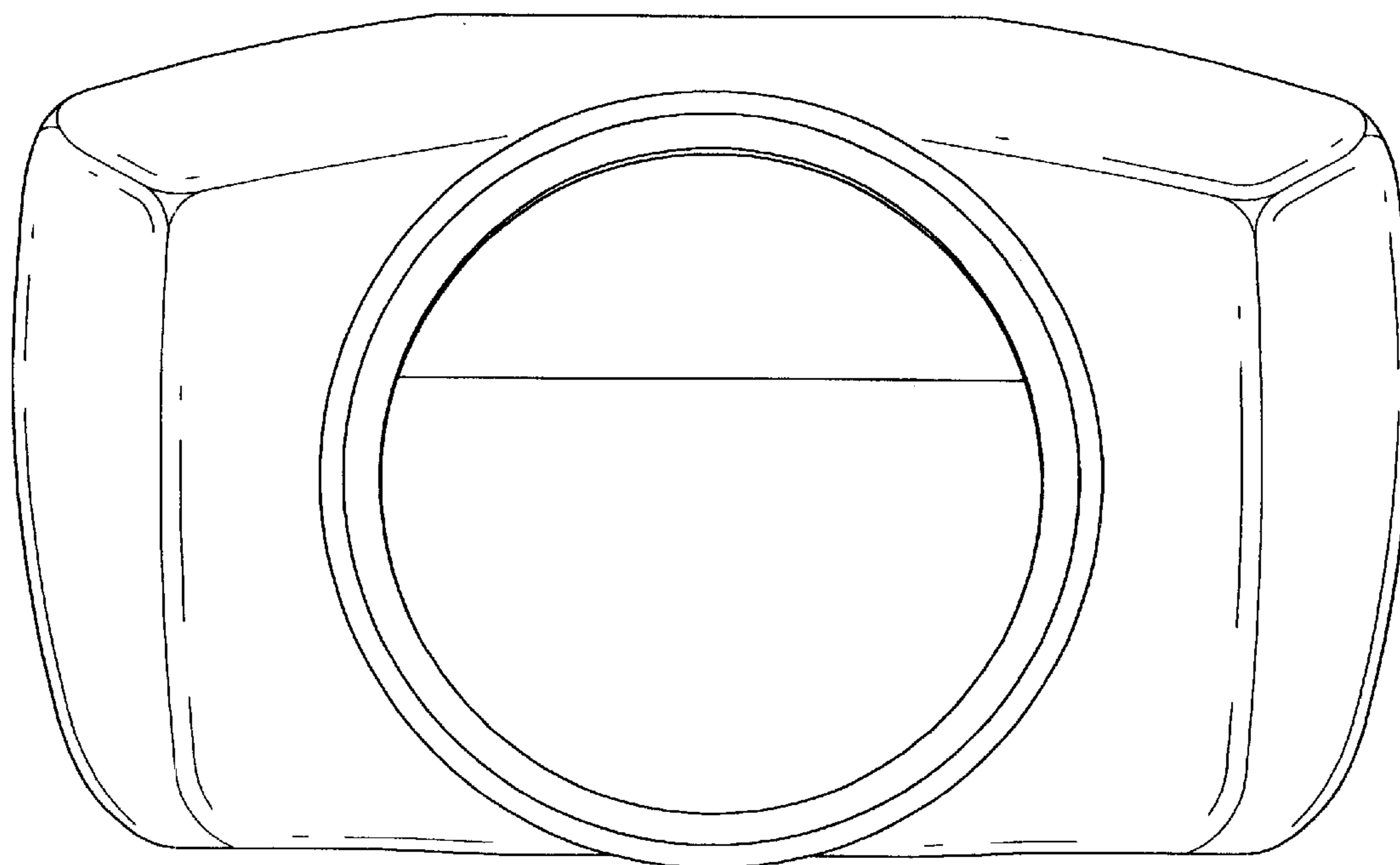

FIG. 3

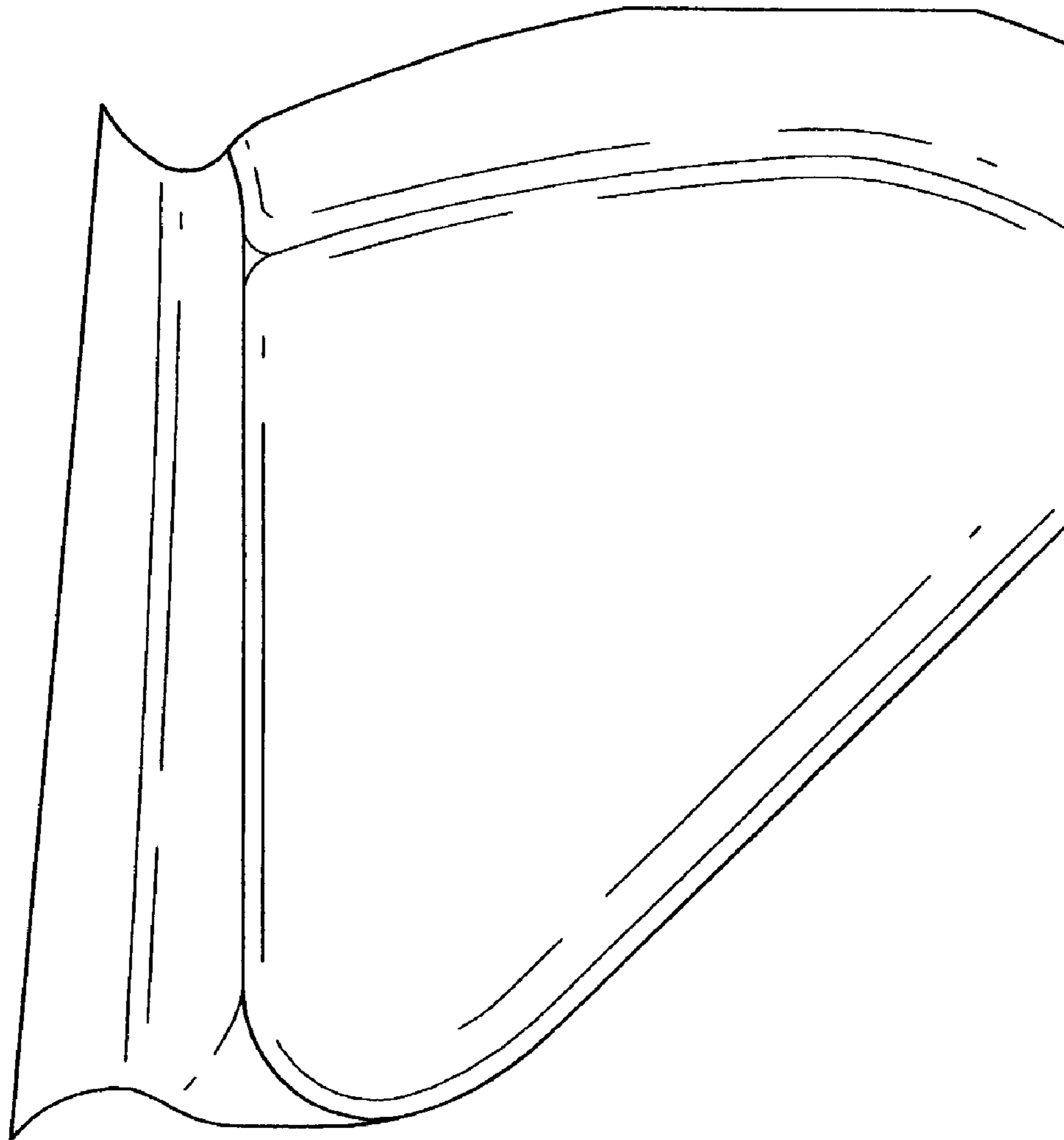

FIG. 4

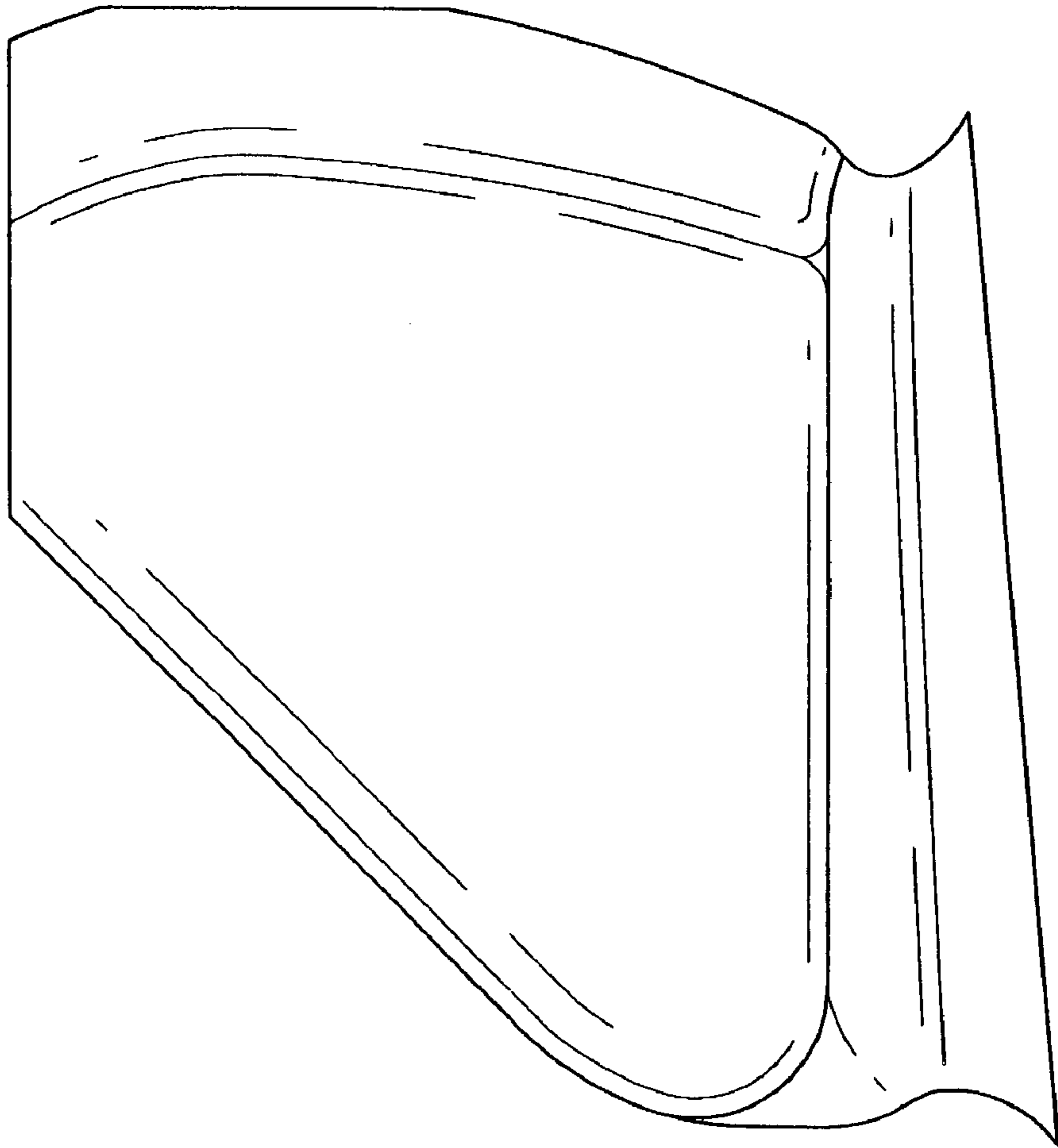

FIG. 5

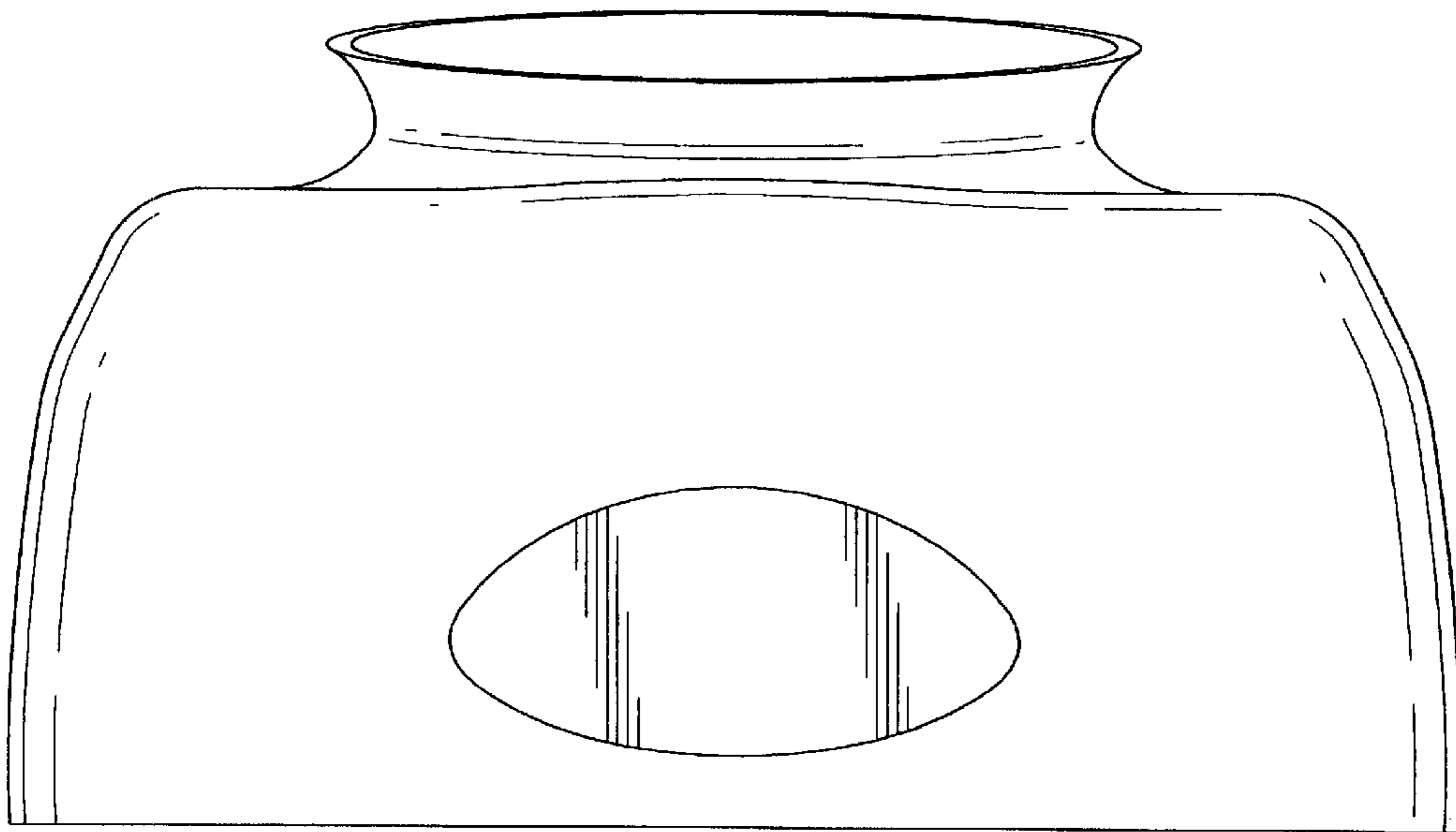

FIG. 6

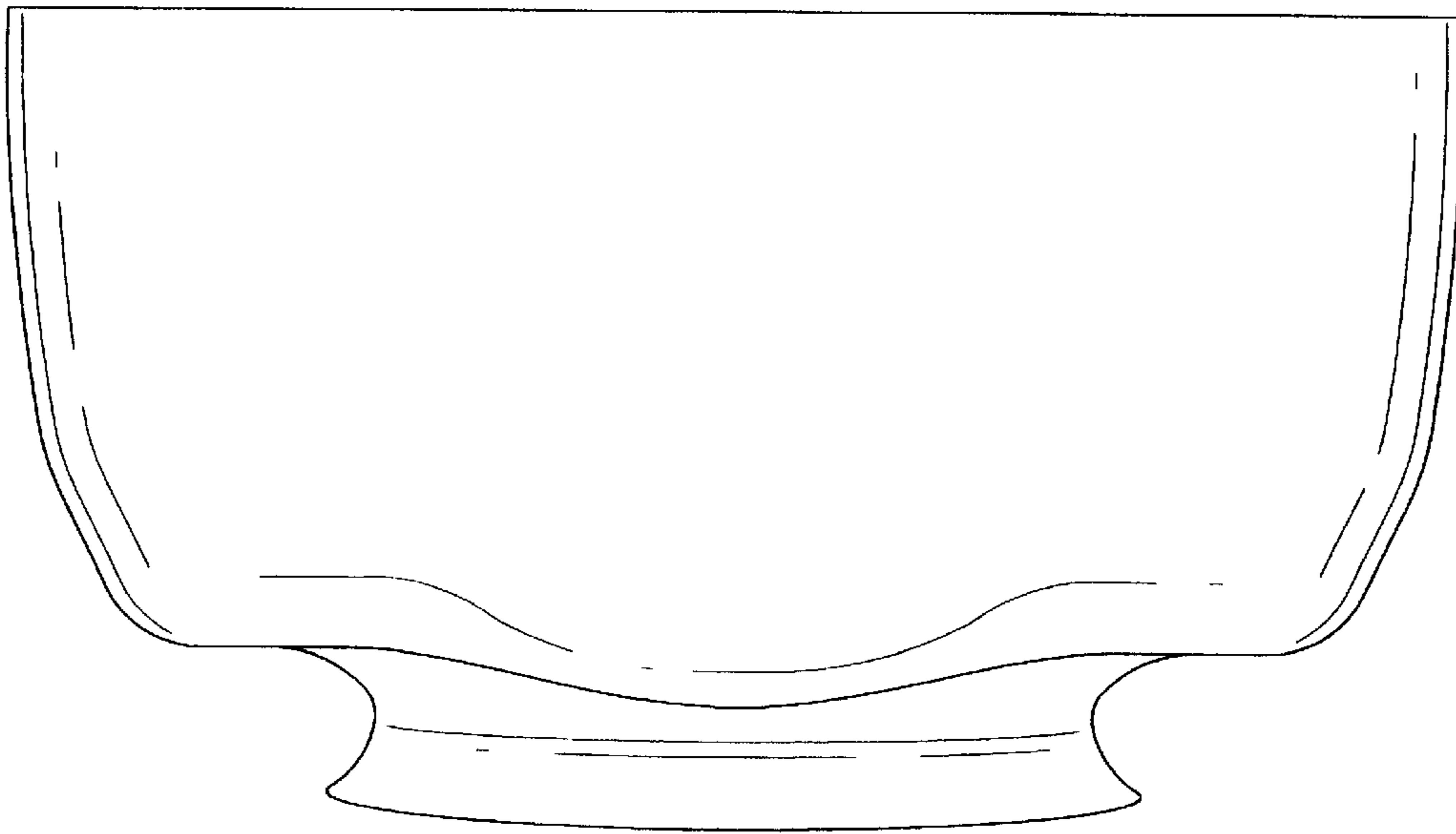

FIG. 7