



US00D530698S

(12) **United States Design Patent** (10) **Patent No.:** **US D530,698 S**
Lee et al. (45) **Date of Patent:** **** Oct. 24, 2006**

(54) **MOBILE PHONE**

(75) Inventors: **Ji-Young Lee**, Seongnam-si (KR);
Sang-Min Hyun, Seoul (KR);
Chang-Soo Lee, Incheon (KR)

(73) Assignee: **Samsung Electronics Co., Ltd.**,
Suwon-si (KR)

(**) **Term:** **14 Years**

(21) **Appl. No.:** **29/241,220**

(22) **Filed:** **Oct. 26, 2005**

(30) **Foreign Application Priority Data**

Apr. 27, 2005 (KR) 30-2005-0014146

(51) **LOC (8) Cl.** **14-03**

(52) **U.S. Cl.** **D14/138; D14/496**

(58) **Field of Classification Search** D14/137,
D14/138, 147-148, 247-248, 144, 496, 156,
D14/341-347, 191, 192; 379/433.01-433.13;
455/575.4, 566, 575.1, 556.1, 556.2, 90.3;
D21/329, 331, 333; D16/208

See application file for complete search history.

(56) **References Cited**

U.S. PATENT DOCUMENTS

D352,285 S	*	11/1994	Khoury et al.	D14/191
D387,078 S	*	12/1997	Akita	D16/202
D423,468 S	*	4/2000	Jenkins	D14/342
D423,493 S	*	4/2000	Hakoda	D14/138
D434,739 S	*	12/2000	Hanna et al.	D14/138
D467,890 S	*	12/2002	Lai et al.	D14/138
D491,156 S	*	6/2004	Kawakami et al.	D14/138
D499,423 S	*	12/2004	Bahroocha et al.	D14/496
D502,457 S	*	3/2005	Eigenstetter et al.	D14/138
D502,703 S	*	3/2005	Tsujimoto et al.	D14/346
D504,120 S	*	4/2005	Edoff	D14/138
D505,407 S	*	5/2005	Itano	D14/138
D508,029 S	*	8/2005	Lee	D14/138
D512,450 S	*	12/2005	Jinde	D16/202

D513,011 S	*	12/2005	Johnson	D14/496
D514,590 S	*	2/2006	Naruki	D14/496
D516,576 S	*	3/2006	Ive et al.	D14/496
D517,042 S	*	3/2006	Byun et al.	D14/191
2003/0092401 A1	*	5/2003	Ikeuchi	455/90
2003/0125079 A1	*	7/2003	Park et al.	455/556
2003/0125094 A1	*	7/2003	Hyun et al.	455/566
2004/0266477 A1	*	12/2004	Murata	455/556.1
2005/0009572 A1	*	1/2005	Ahn et al.	455/566
2005/0059438 A1	*	3/2005	Jellicoe	455/575.1
2005/0075082 A1	*	4/2005	Iwai et al.	455/90.3
2005/0085280 A1	*	4/2005	Takahashi	455/575.1
2005/0255897 A1	*	11/2005	Lee et al.	455/575.4
2005/0266897 A1	*	12/2005	Ahn et al.	455/575.1

OTHER PUBLICATIONS

NEC N938 telephone, announced second quarter 2005, [online], [retrieved on May 15, 2006]. Retrieved from Internet ,URL: <http://www.gsmarena.com>>.*

(Continued)

Primary Examiner—Jeffrey Asch
(74) *Attorney, Agent, or Firm*—Staas & Halsey LLP

(57) **CLAIM**

The ornamental design for the mobile phone, as shown and described.

DESCRIPTION

FIG. 1 is a perspective view of the mobile phone showing our design;
FIG. 2 is a front view thereof;
FIG. 3 is a rear view thereof;
FIG. 4 is a left side view thereof;
FIG. 5 is a right side view thereof;
FIG. 6 is a top plan view thereof;
FIG. 7 is a bottom plan view thereof; and,
FIG. 8 is a perspective view thereof with strap attachment. The broken line showing of a strap in FIG. 8 is included for illustrative purposes only and forms no part of the claimed design.

1 Claim, 4 Drawing Sheets

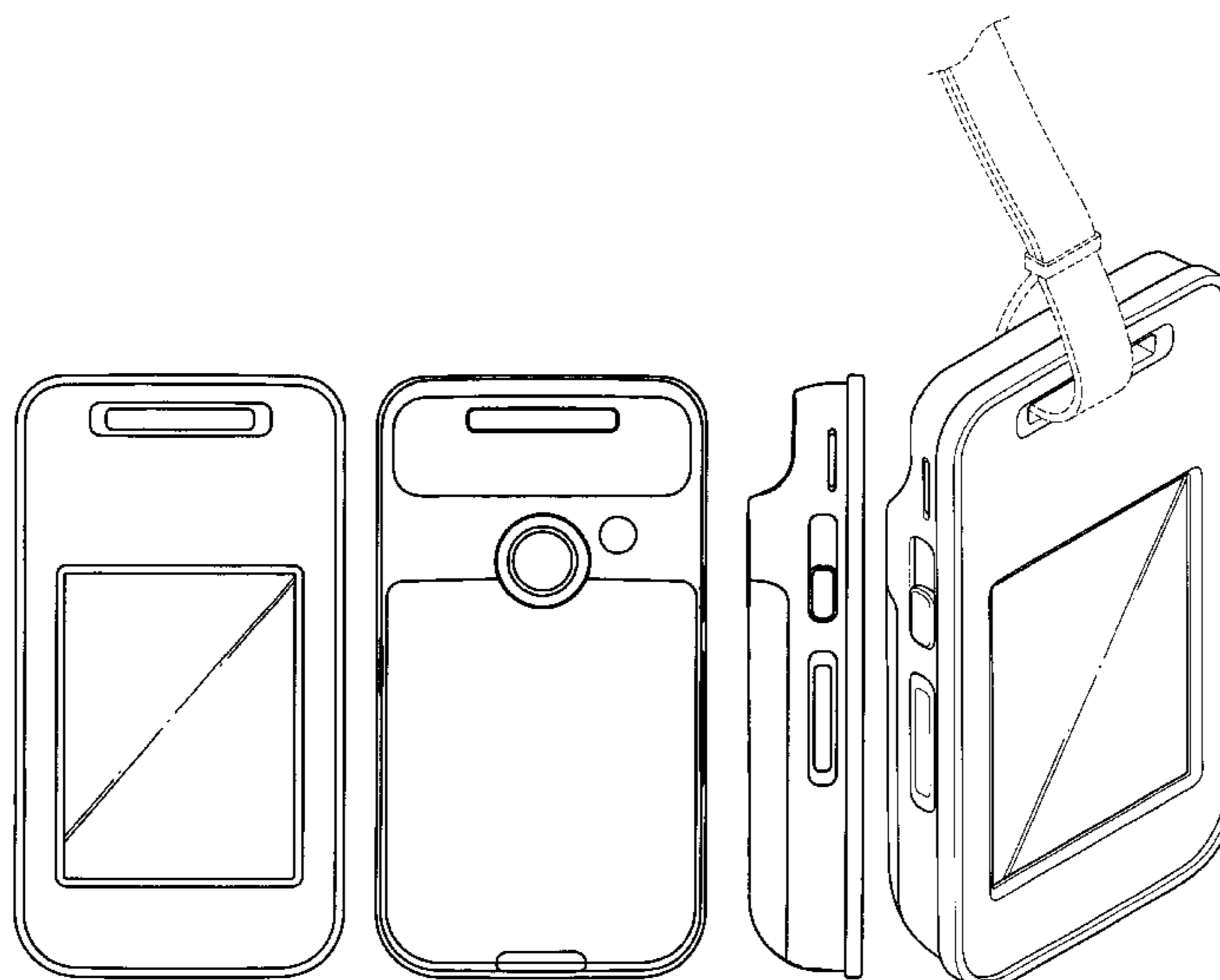

OTHER PUBLICATIONS

NEC N930 telephone, announced fourth quarter 2004, [online], [retrieved on May 5, 2006]. Retrieved from Internet , URL: <http://www.gsmarena.com>>.*

NEC N940 telephone, announced fourth quarter 2004, [online], [retrieved on May 5, 2006]. Retrieved from Internet , URL: <http://www.gsmarena.com>>.*

* cited by examiner

FIG. 1

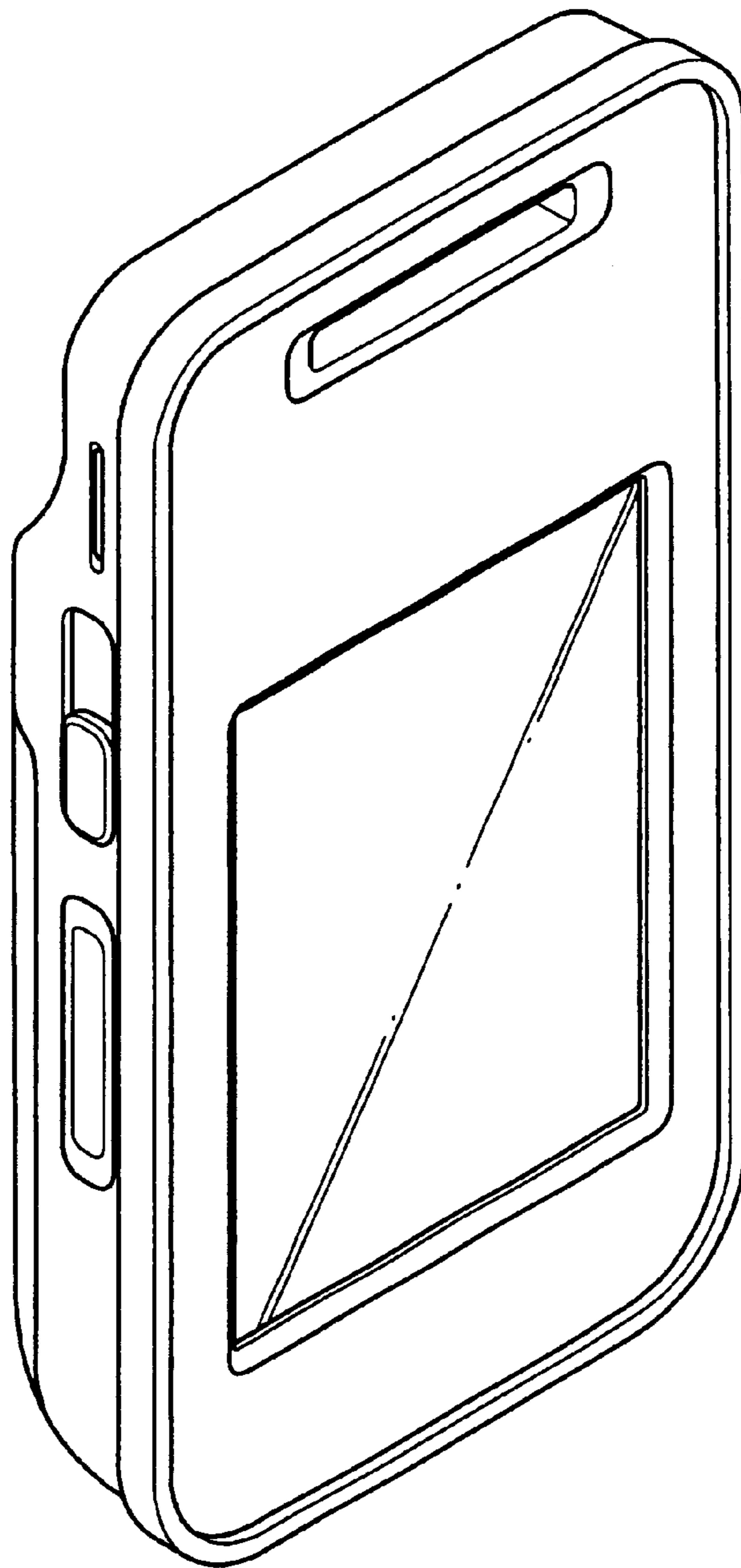

FIG. 2

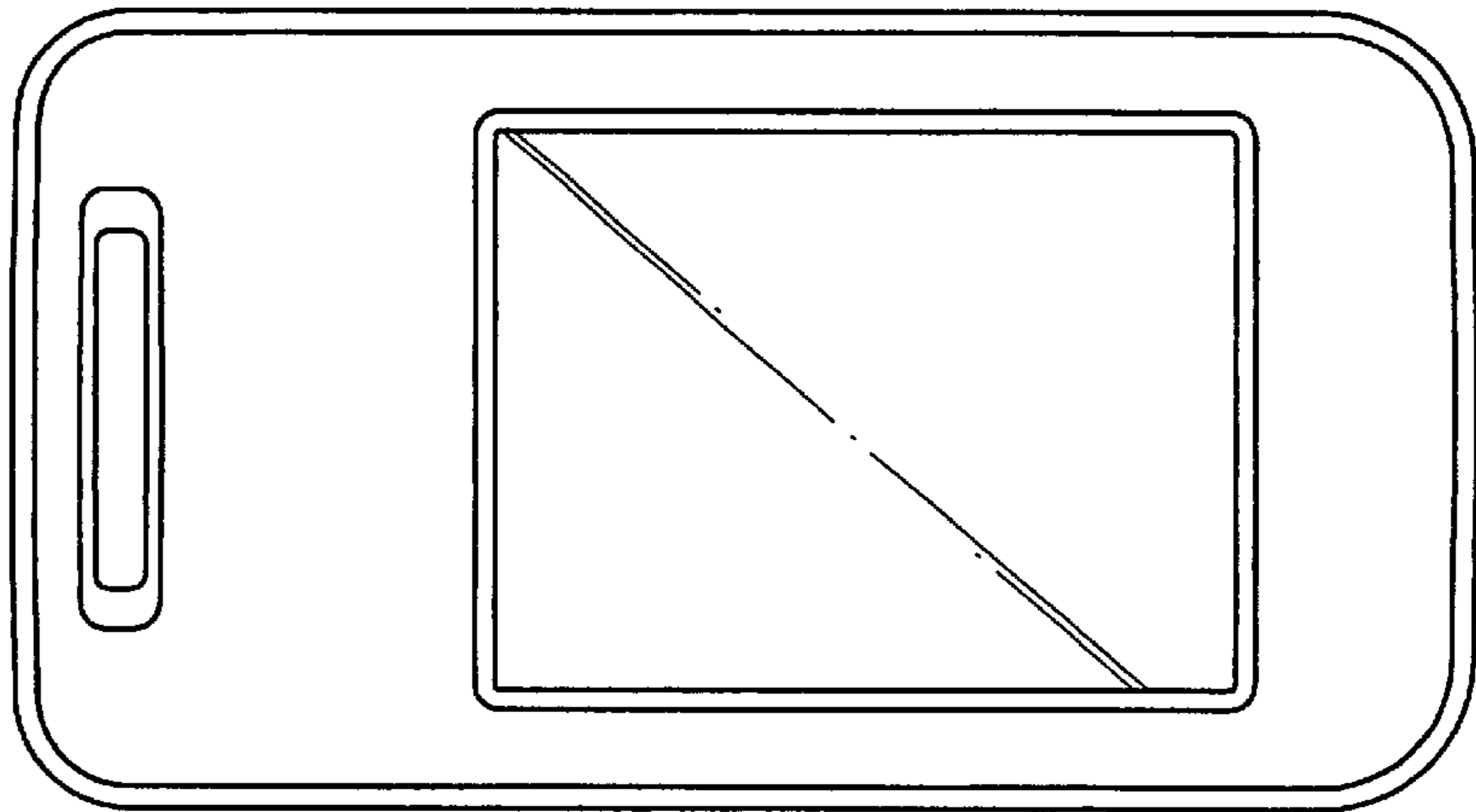

FIG. 3

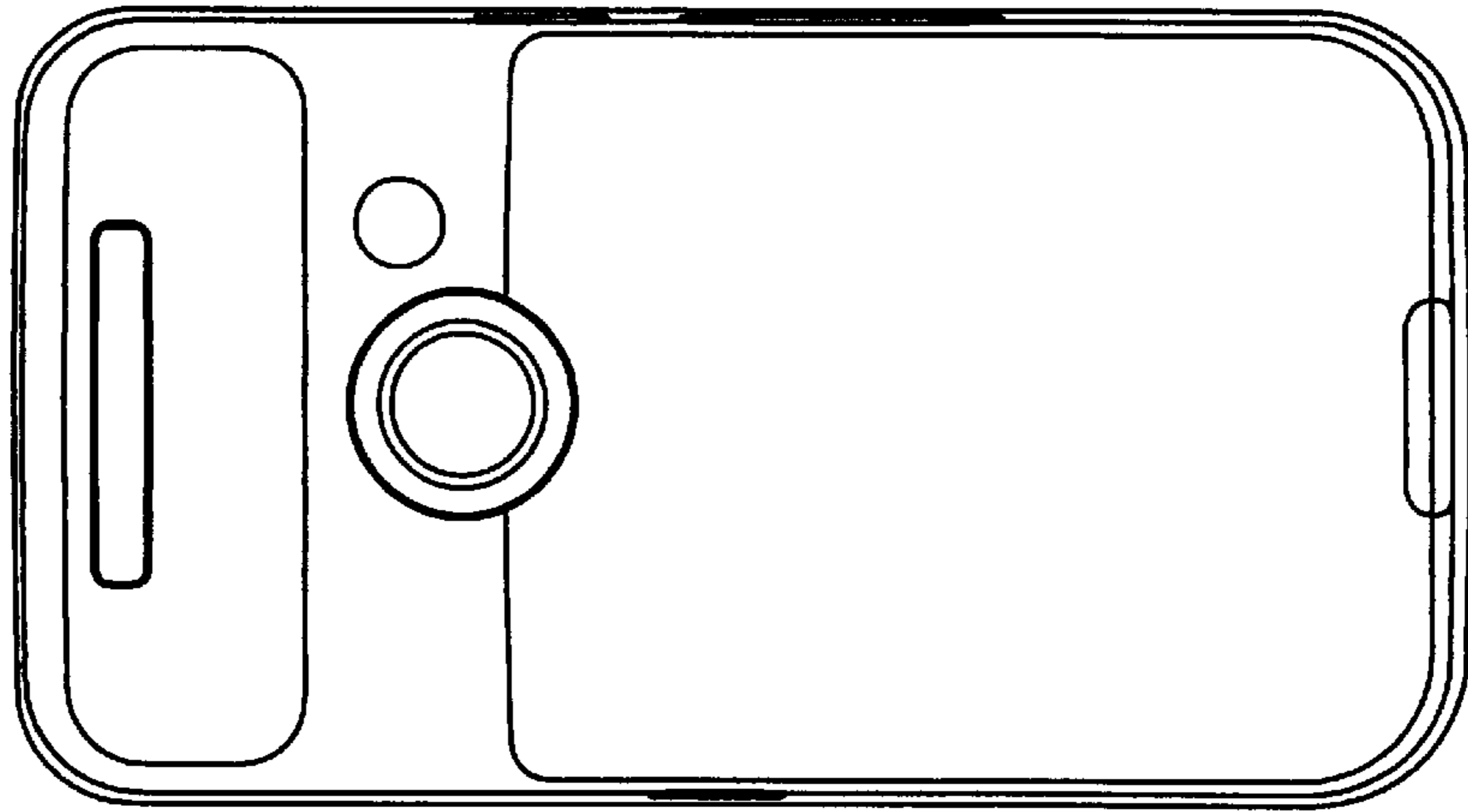

FIG. 4

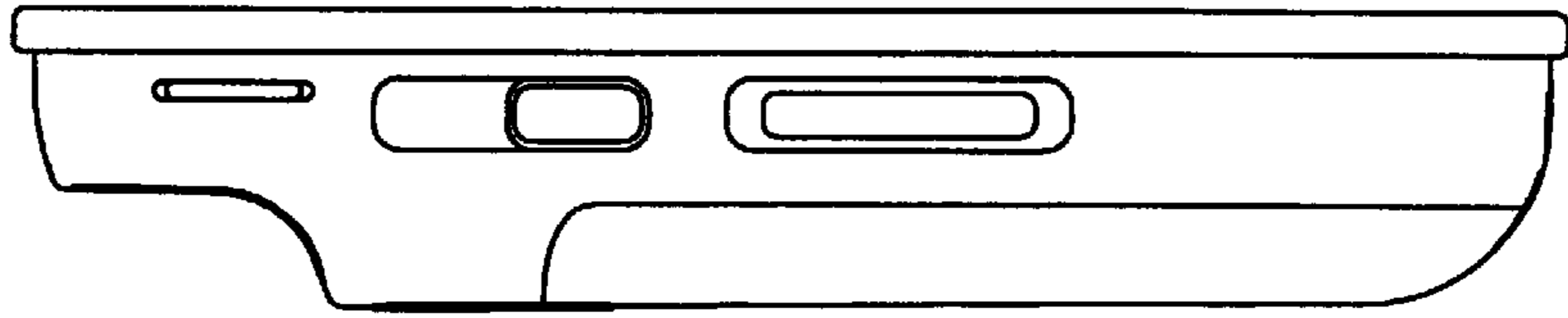

FIG. 5

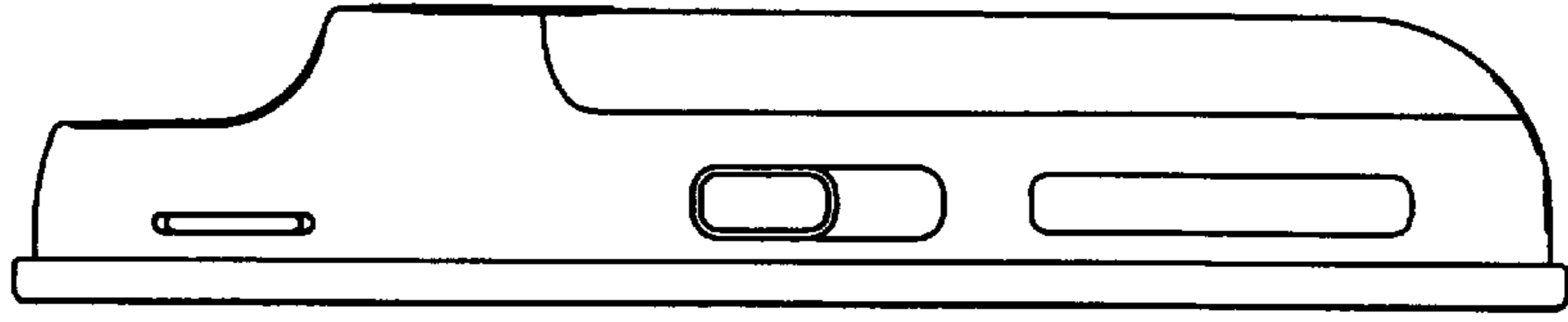

FIG. 6

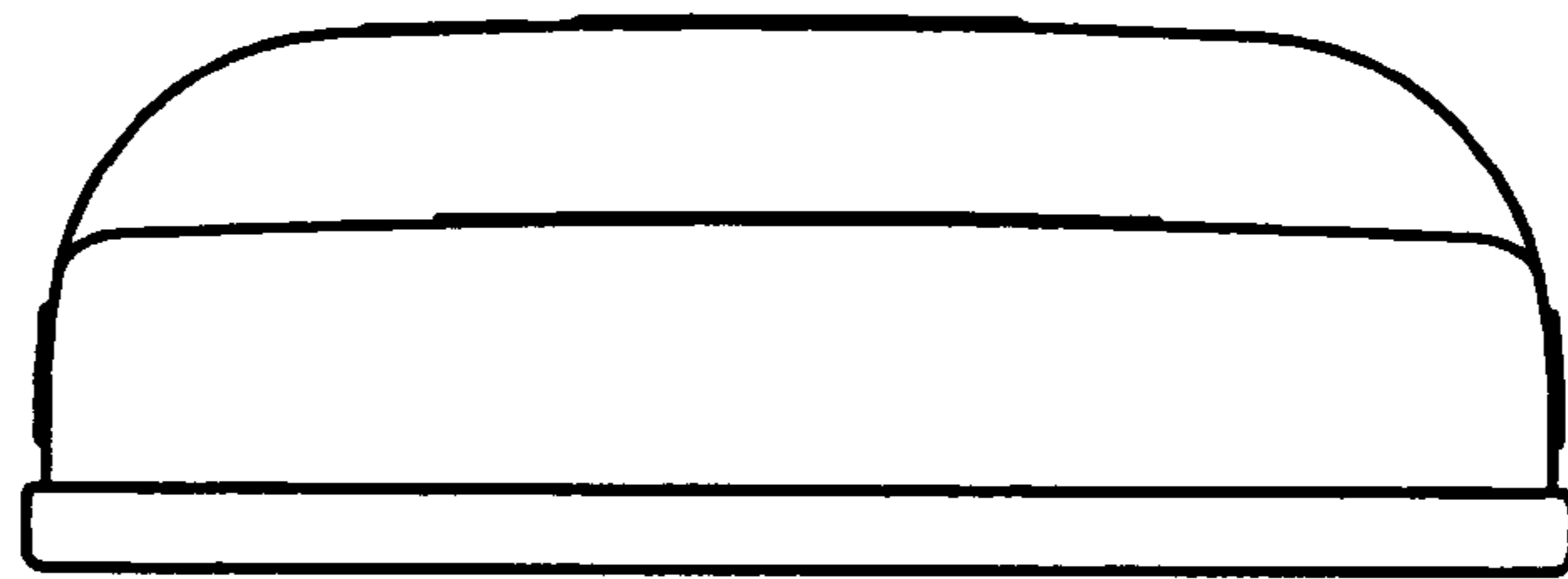

FIG. 7

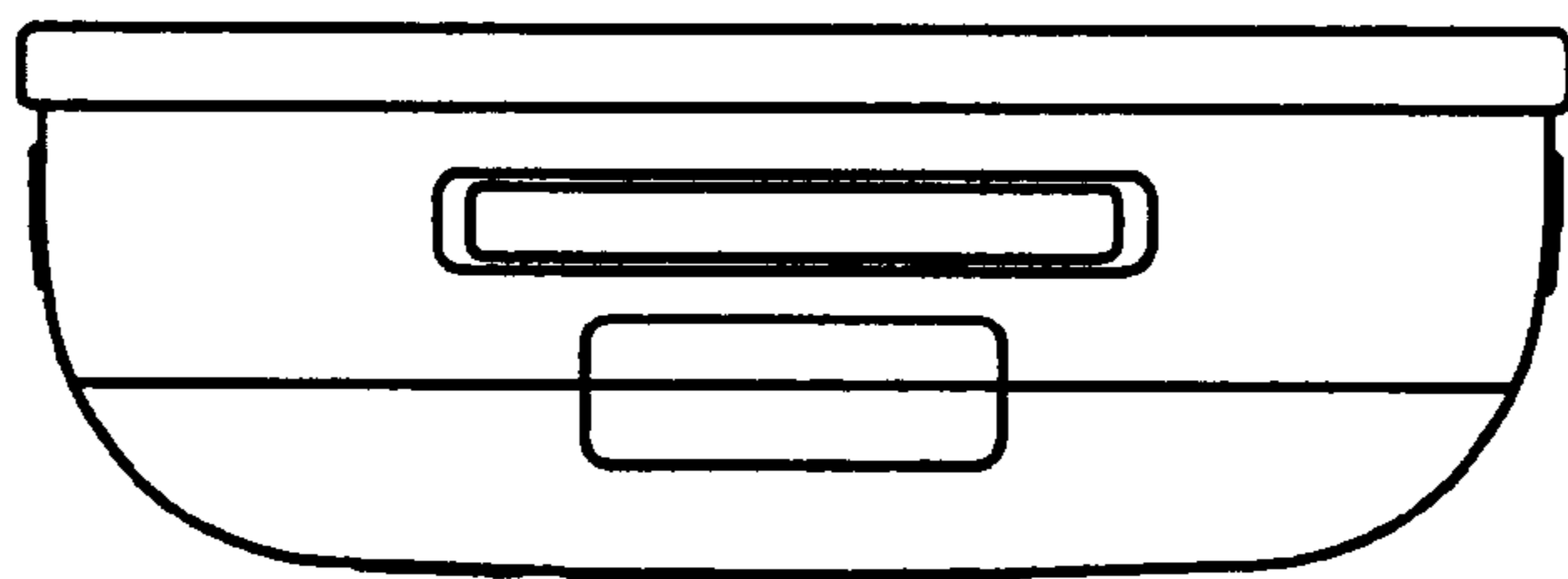

FIG. 8

