

US00D530645S

(12) **United States Design Patent**
Perry et al.

(10) **Patent No.:** **US D530,645 S**
(45) **Date of Patent:** **** Oct. 24, 2006**

(54) **FLOWERPOT FIGURINE**

D342,698 S * 12/1993 Schell et al. D11/158
D454,811 S 3/2002 Perry et al.

(76) Inventors: **Max W. Perry**, 6608 E. M-21,
Corunna, MI (US) 48817; **Jean C.**
Perry, 6608 E. M-21, Corunna, MI
(US) 48817

OTHER PUBLICATIONS

Max Perry, Applicant supplied photograph #1, photograph is a picture of a figurine that has been in use for more than 1 year prior to the pending application.
Max Perry, Applicant supplied photograph #2, photograph is a picture of a figurine that has been in use for more than 1 year prior to the pending application.

(**) Term: **14 Years**

* cited by examiner

(21) Appl. No.: **29/244,130**

(22) Filed: **Dec. 6, 2005**

(51) **LOC (8) Cl.** **11-02**

Primary Examiner—Catherine Tuttle

(52) **U.S. Cl.** **D11/160**

(74) *Attorney, Agent, or Firm*—Paparella & Associates;
Joseph A. Paparella

(58) **Field of Classification Search** D11/128,
D11/131, 150, 157, 158, 160; D21/576, 578,
D21/621–649; D20/31; 446/97–100, 268,
446/321, 385; 428/15, 16, 39, 542.2, 542.4
See application file for complete search history.

(57) **CLAIM**

The ornamental design for a flowerpot figurine, as shown.

(56) **References Cited**

DESCRIPTION

U.S. PATENT DOCUMENTS

D117,237 S * 10/1939 Zidek D27/107
D174,184 S * 3/1955 Lingstrom D21/587
D178,523 S * 8/1956 Lackovic D21/578
2,881,559 A * 4/1959 Glass 446/289
D187,177 S * 2/1960 Lawson D20/31
D235,503 S * 6/1975 Fry D23/403
D337,150 S * 7/1993 Klee D23/221

FIG. 1 is a front view of the flowerpot figurine;
FIG. 2 is a left side view thereof;
FIG. 3 is a rear view thereof;
FIG. 4 is a right side view thereof;
FIG. 5 is a top view thereof; and,
FIG. 6 is a bottom view thereof.

1 Claim, 5 Drawing Sheets

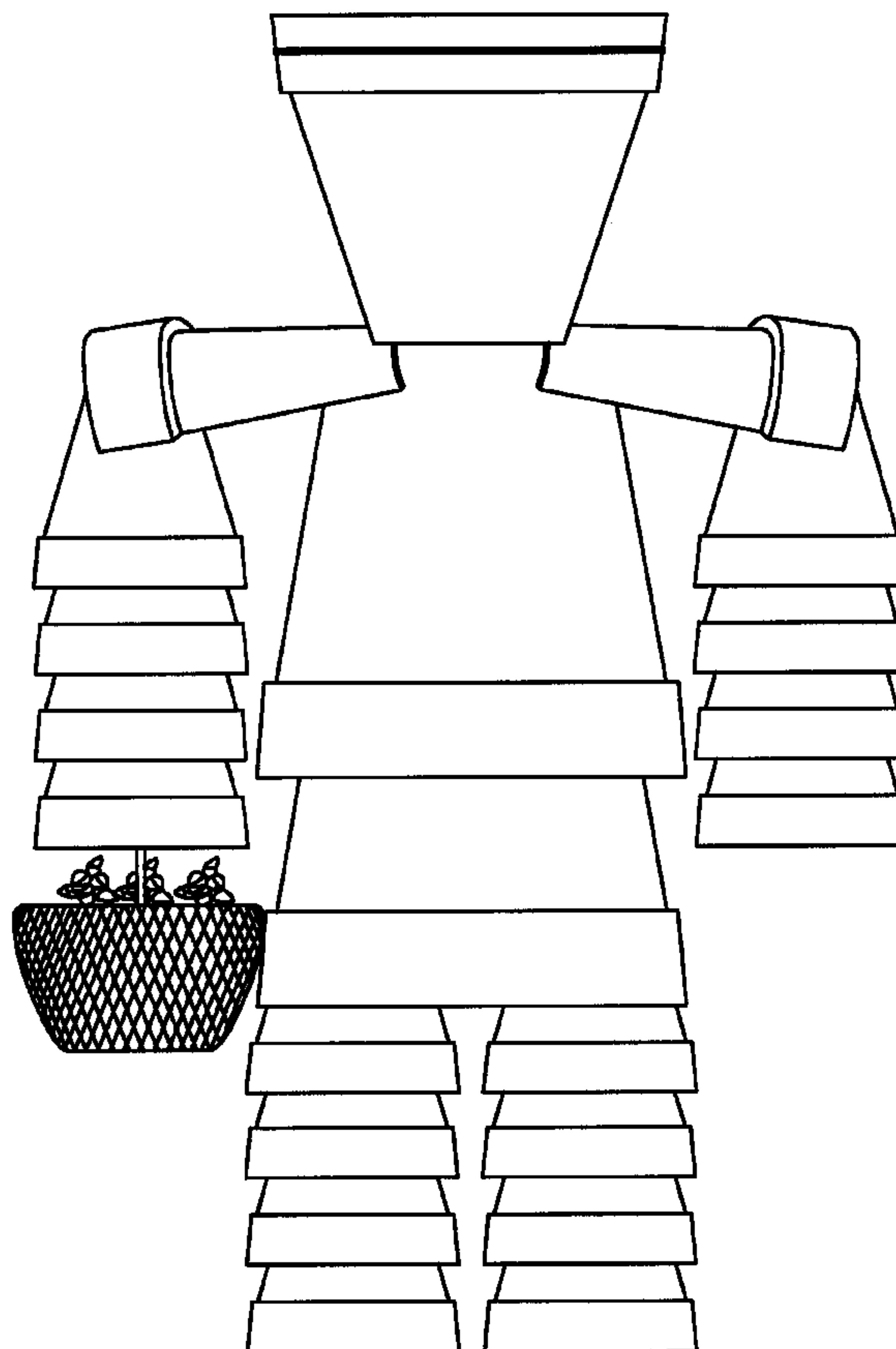

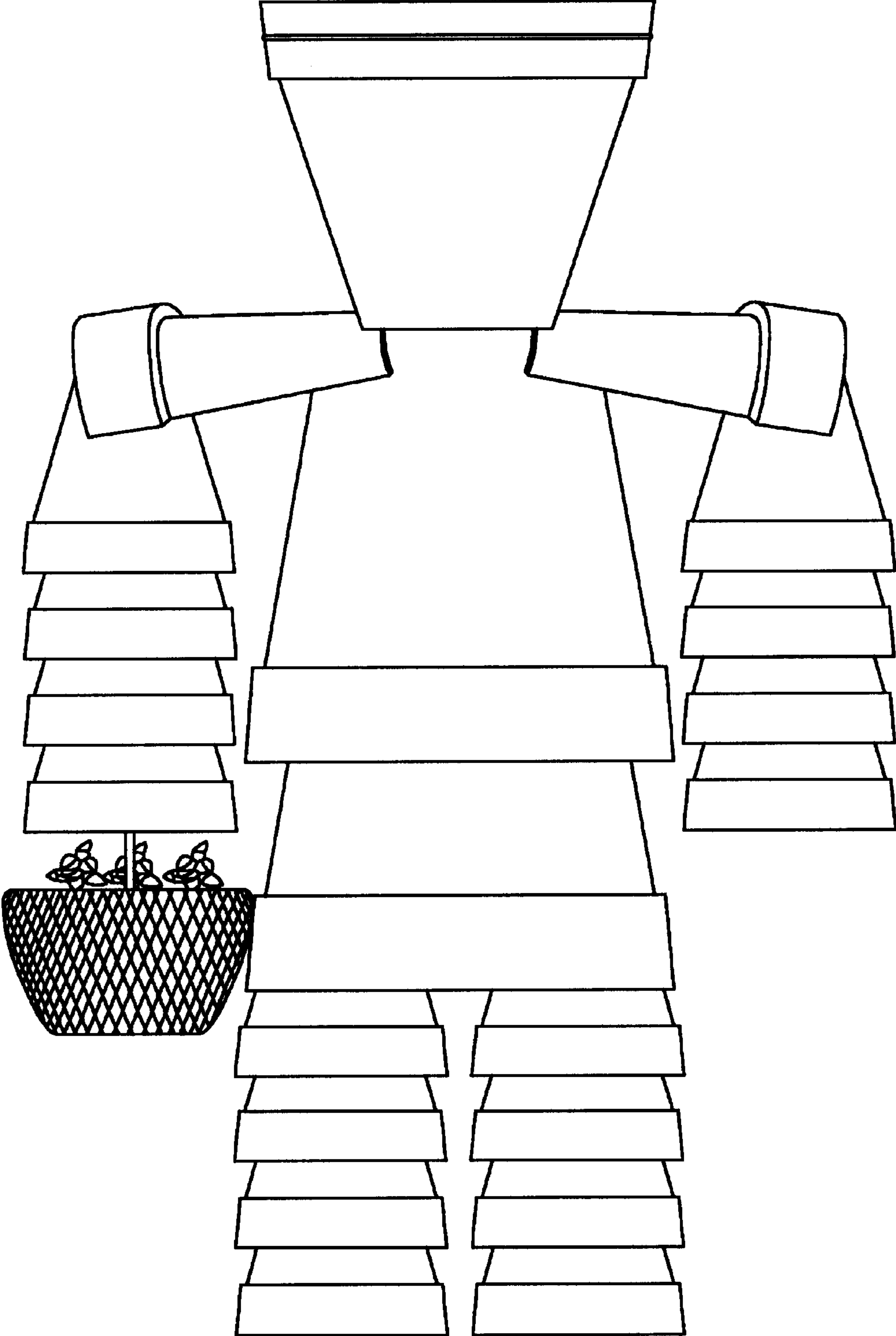

FIG. 1

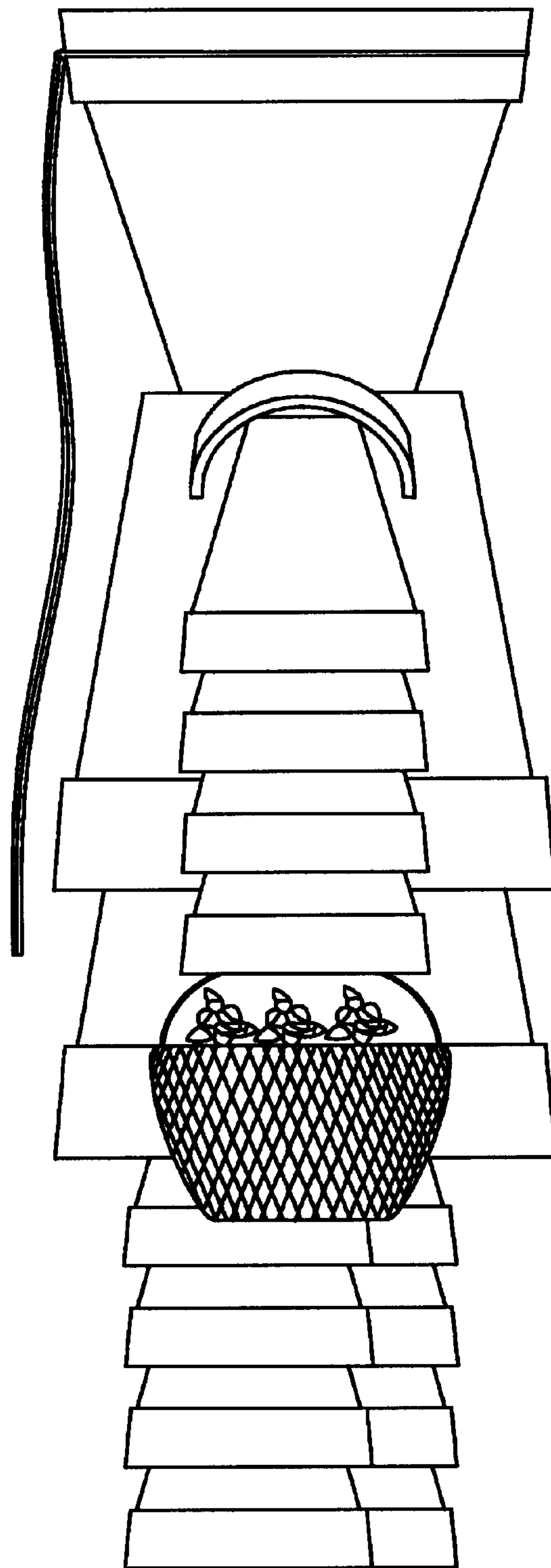

FIG. 2

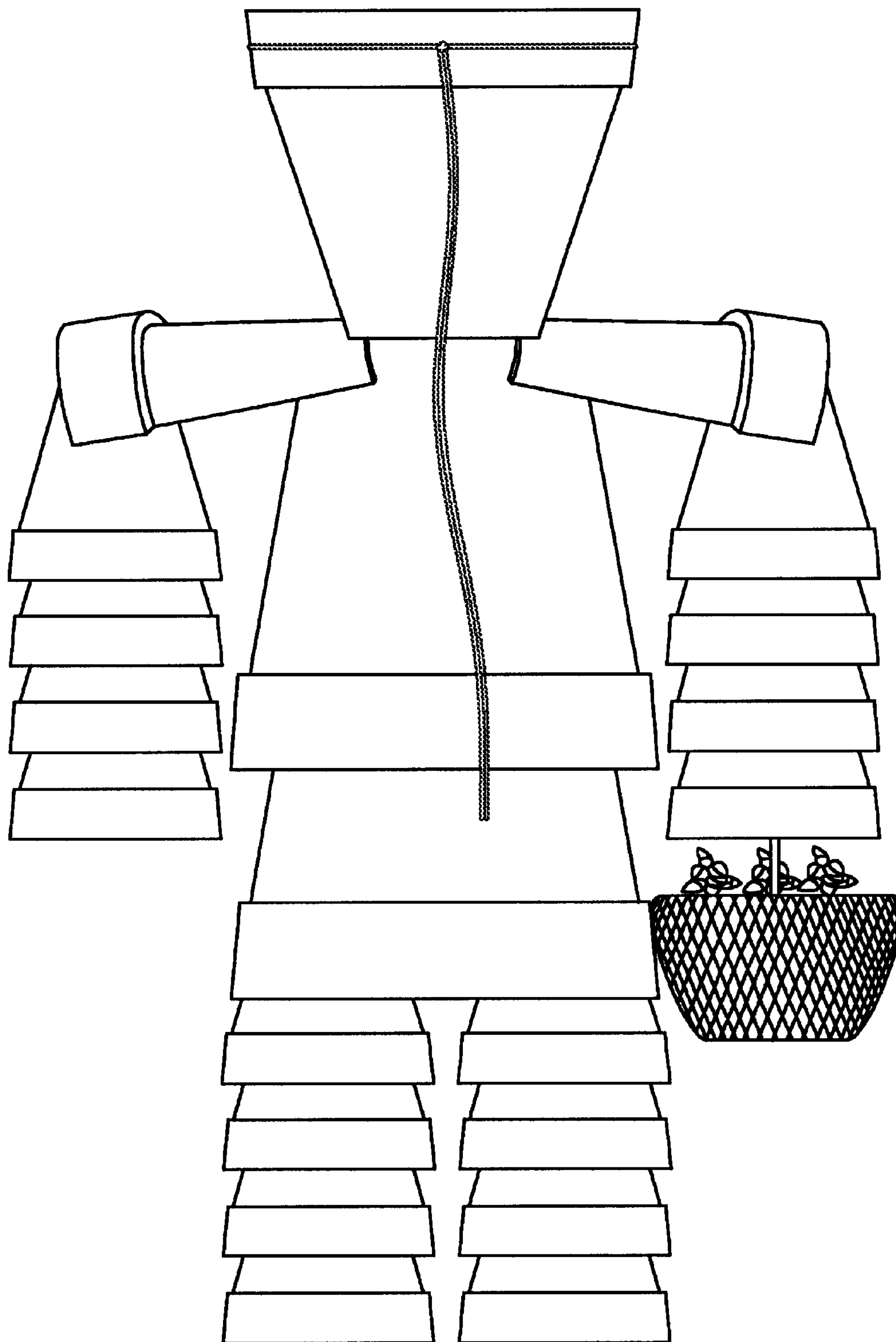

FIG. 3

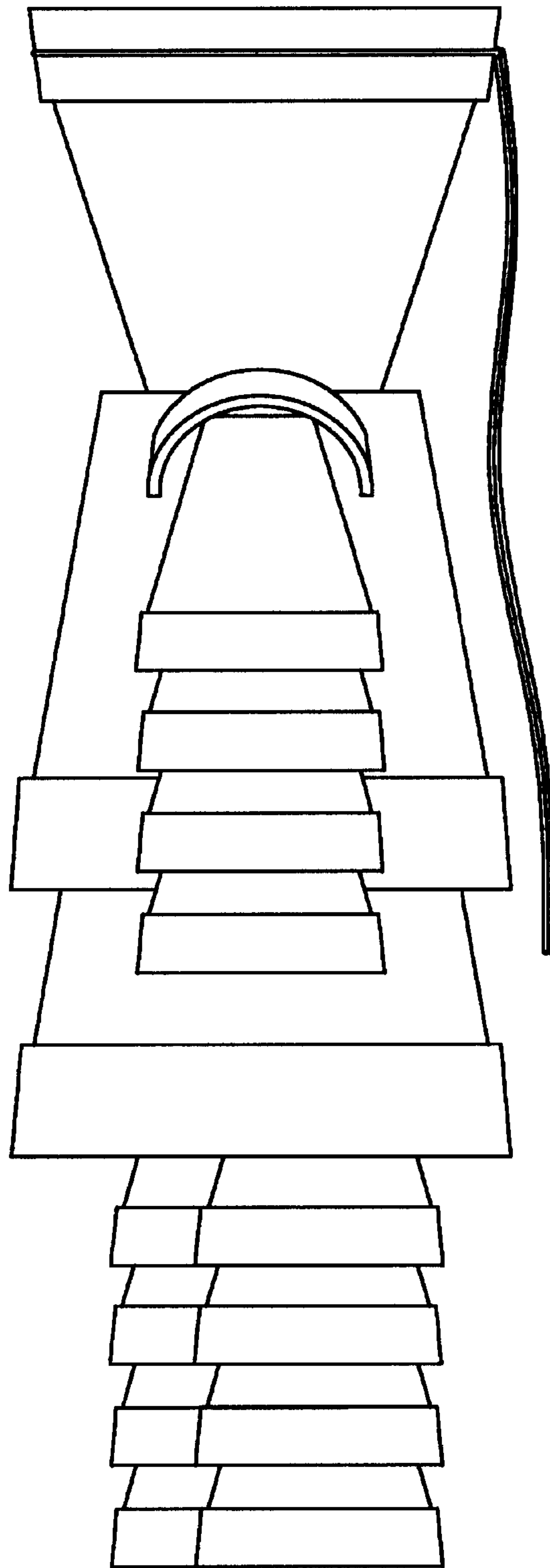

FIG. 4

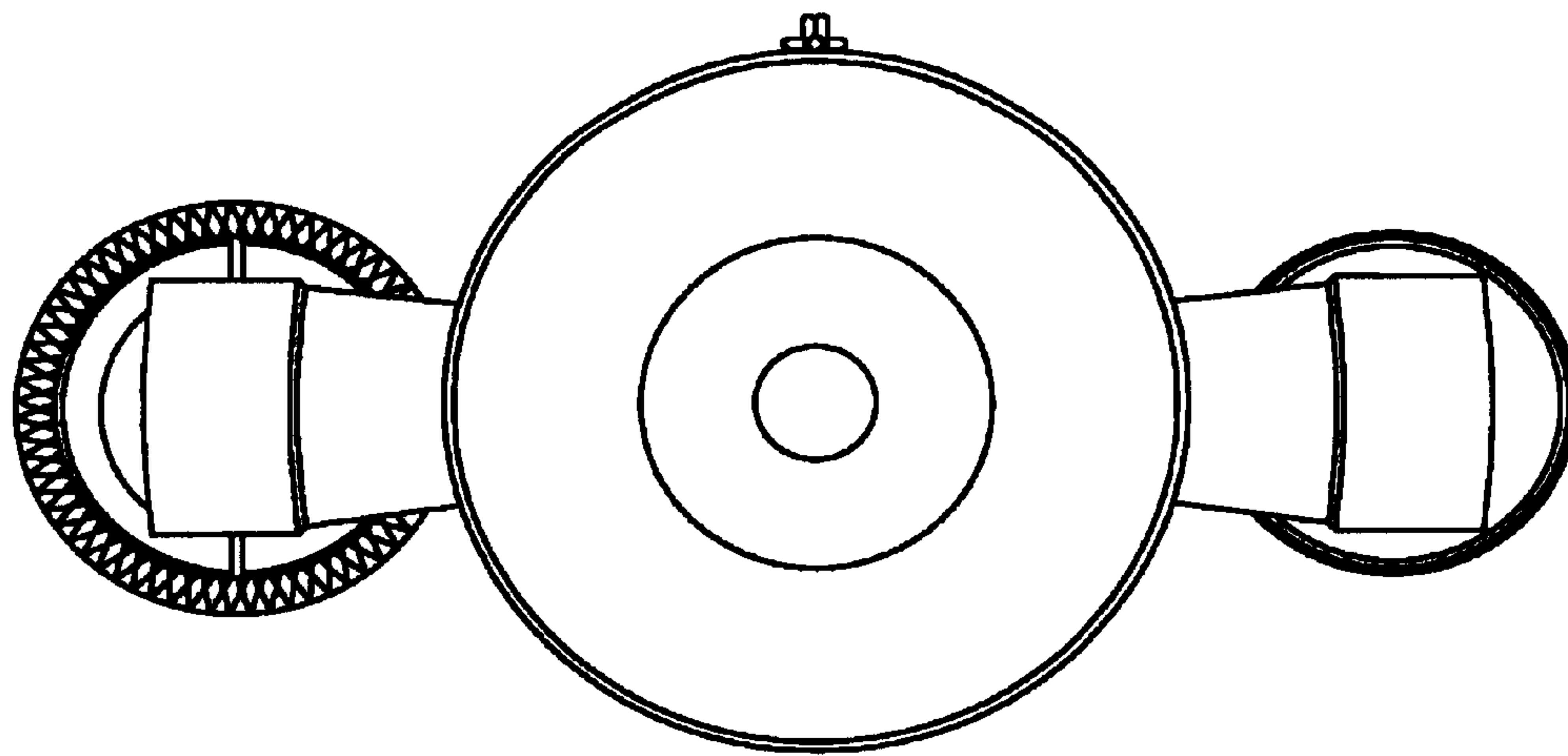

FIG. 5

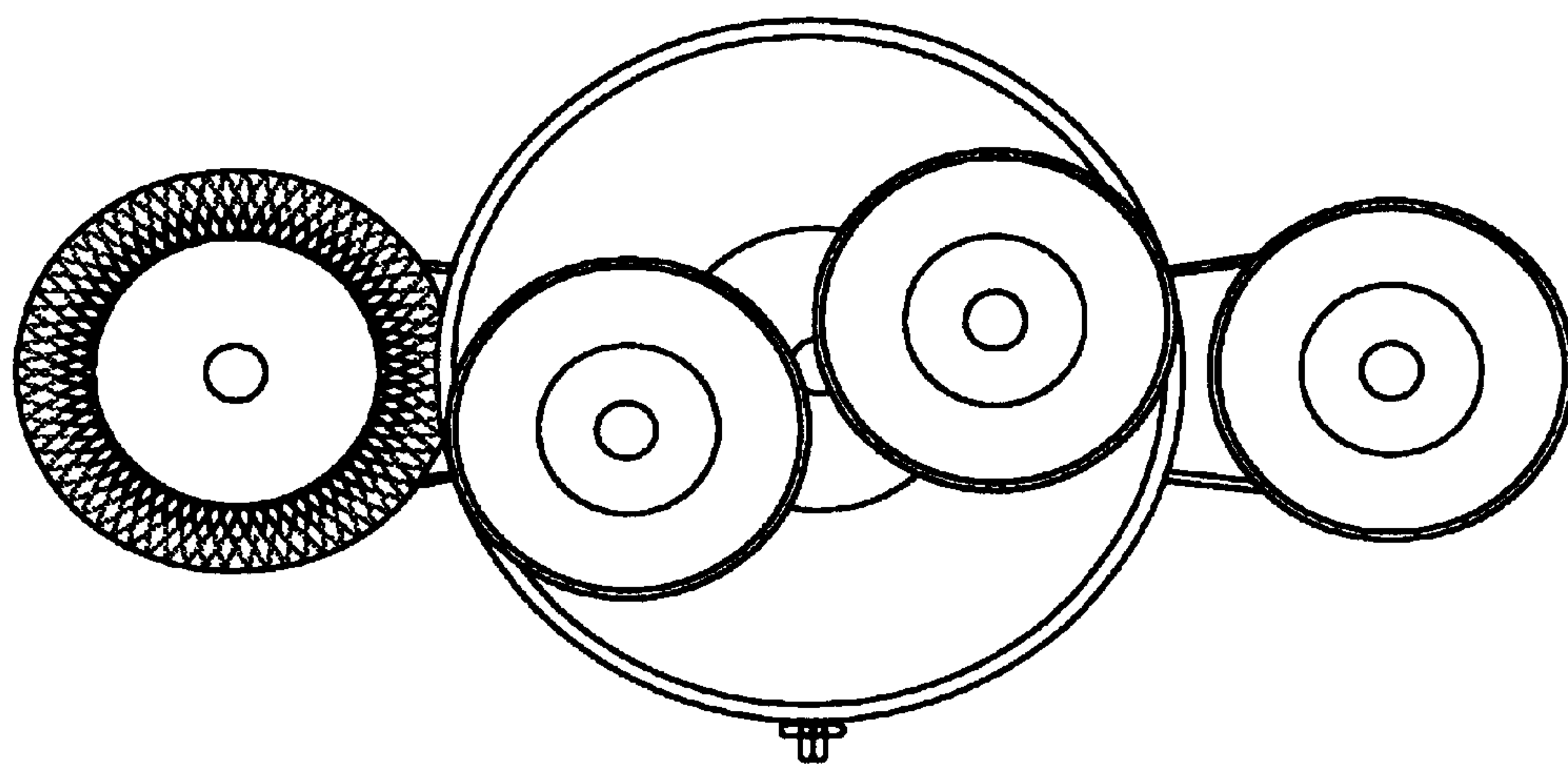

FIG. 6