



US00D530592S

(12) **United States Design Patent**
Poon

(10) **Patent No.:** **US D530,592 S**

(45) **Date of Patent:** **** Oct. 24, 2006**

(54) **HANDLE**

(75) Inventor: **Tit Wing Poon**, New Territories (HK)

(73) Assignee: **Tupor Limited**, Shatin (HK)

(**) Term: **14 Years**

(21) Appl. No.: **29/237,593**

(22) Filed: **Sep. 2, 2005**

(51) **LOC (8) Cl.** **08-06**

(52) **U.S. Cl.** **D8/306**

(58) **Field of Classification Search** D8/300,
D8/306, 315, 316, DIG. 1, 338; D7/393,
D7/394, 601, 619.1, 622; D9/434, 443, 455;
116/406, 411; 220/212, 5, 284, 755, 773;
248/100; 294/31.2, 33, 137, 163, 171
See application file for complete search history.

(56) **References Cited**

U.S. PATENT DOCUMENTS

D29,333 S	*	9/1898	Seymour	D8/315
D197,202 S	*	12/1963	Finkelstein	D8/306
D198,196 S	*	5/1964	Buchanan et al.	D9/434
D204,295 S	*	4/1966	Brekke	D7/622
D232,614 S	*	9/1974	Brown	D7/622
4,004,722 A	*	1/1977	Olivier	294/171

D290,935 S	*	7/1987	Williams	D9/434
D314,150 S	*	1/1991	Preciutti	D9/455
D510,522 S	*	10/2005	Laveault et al.	D9/443

* cited by examiner

Primary Examiner—Paula A. Greene

(74) *Attorney, Agent, or Firm*—Intellectual Property Law Group LLP; Otto O. Lee; Juneko Jackson

(57) **CLAIM**

The ornamental design for a handle, as shown and described.

DESCRIPTION

FIG. 1 is a perspective view of a handle in an open position, embodying my new design;
 FIG. 2 is a perspective view thereof in a closed position;
 FIG. 3 is a top plan view of FIG. 1;
 FIG. 4 is a front elevational view thereof;
 FIG. 5 is a bottom plan view thereof;
 FIG. 6 is a right side elevational view thereof;
 FIG. 7 is a left side elevational view thereof;
 FIG. 8 is a top plan view of FIG. 2;
 FIG. 9 is a front elevational view thereof;
 FIG. 10 is a bottom plan view thereof;
 FIG. 11 is a right side elevational view thereof; and,
 FIG. 12 is a left side elevational view thereof.

1 Claim, 5 Drawing Sheets

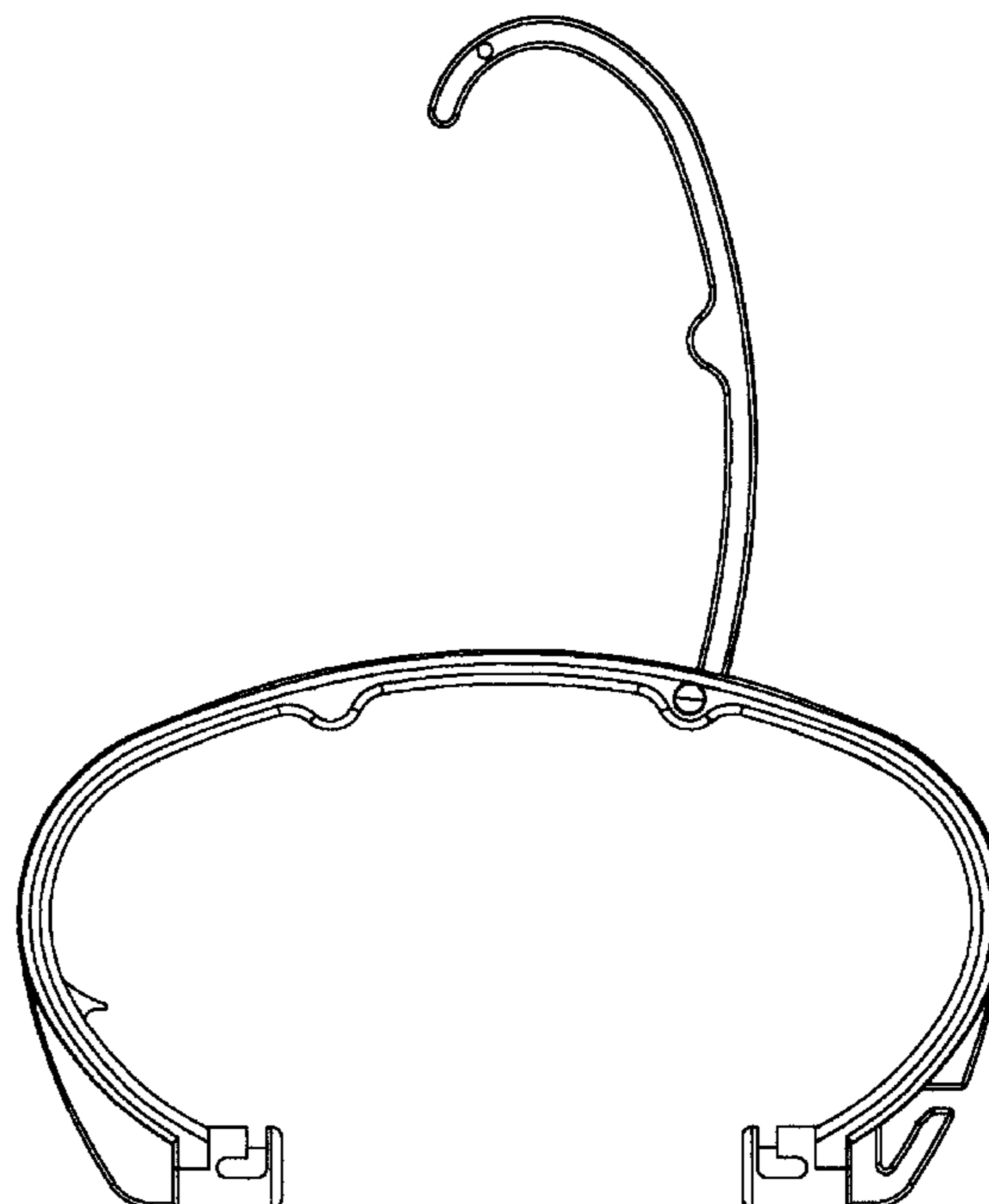
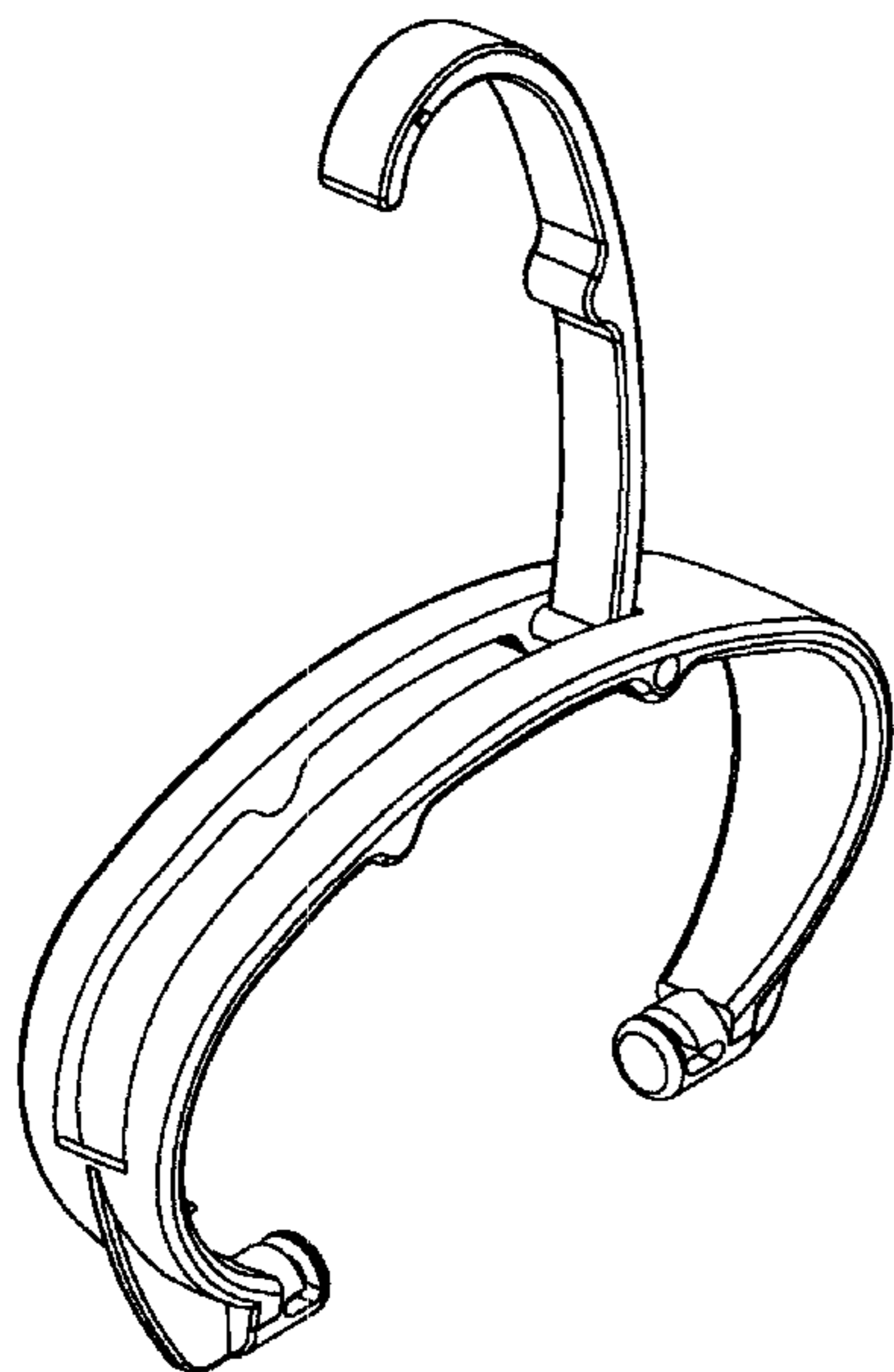

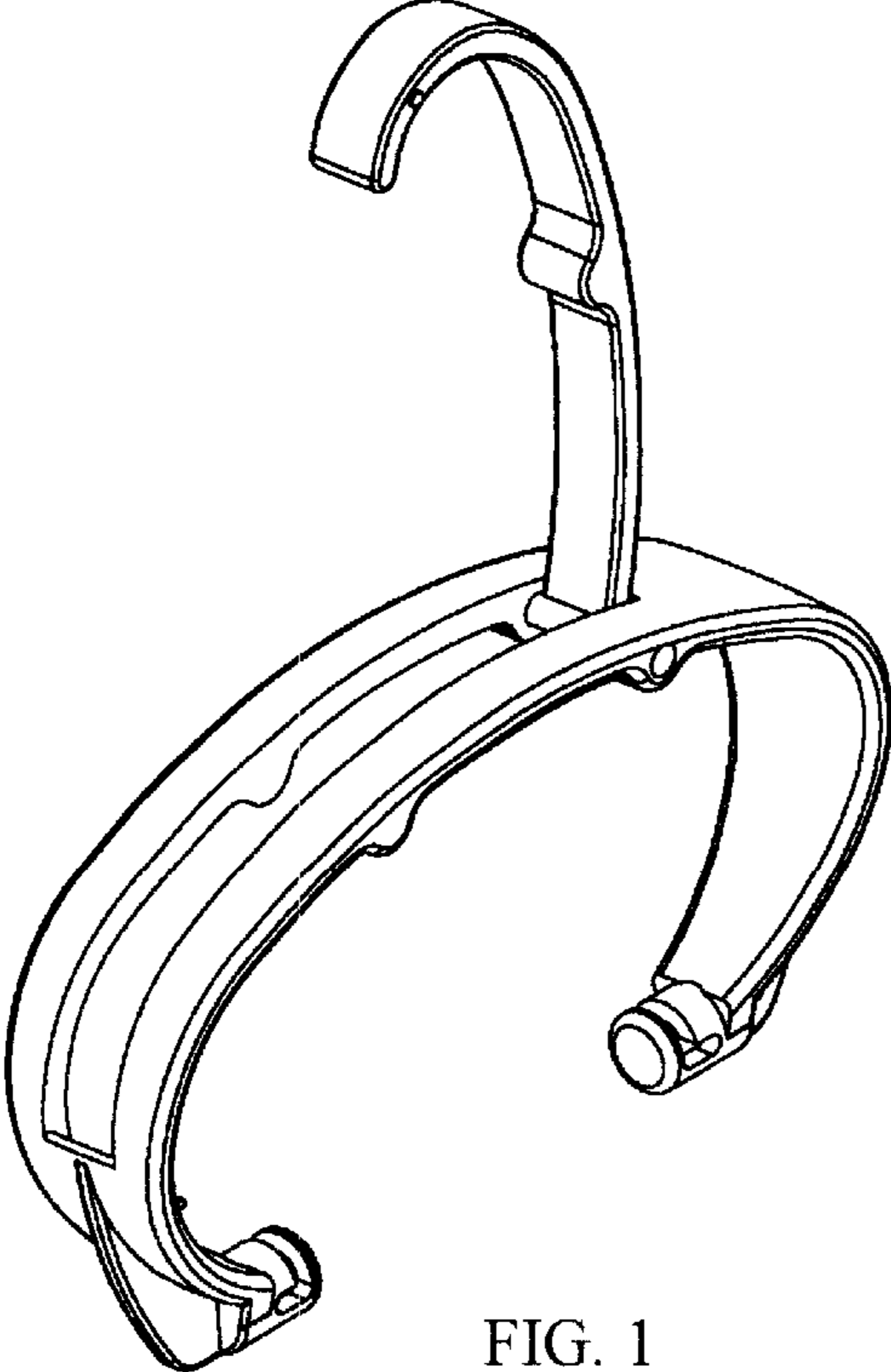

FIG. 1

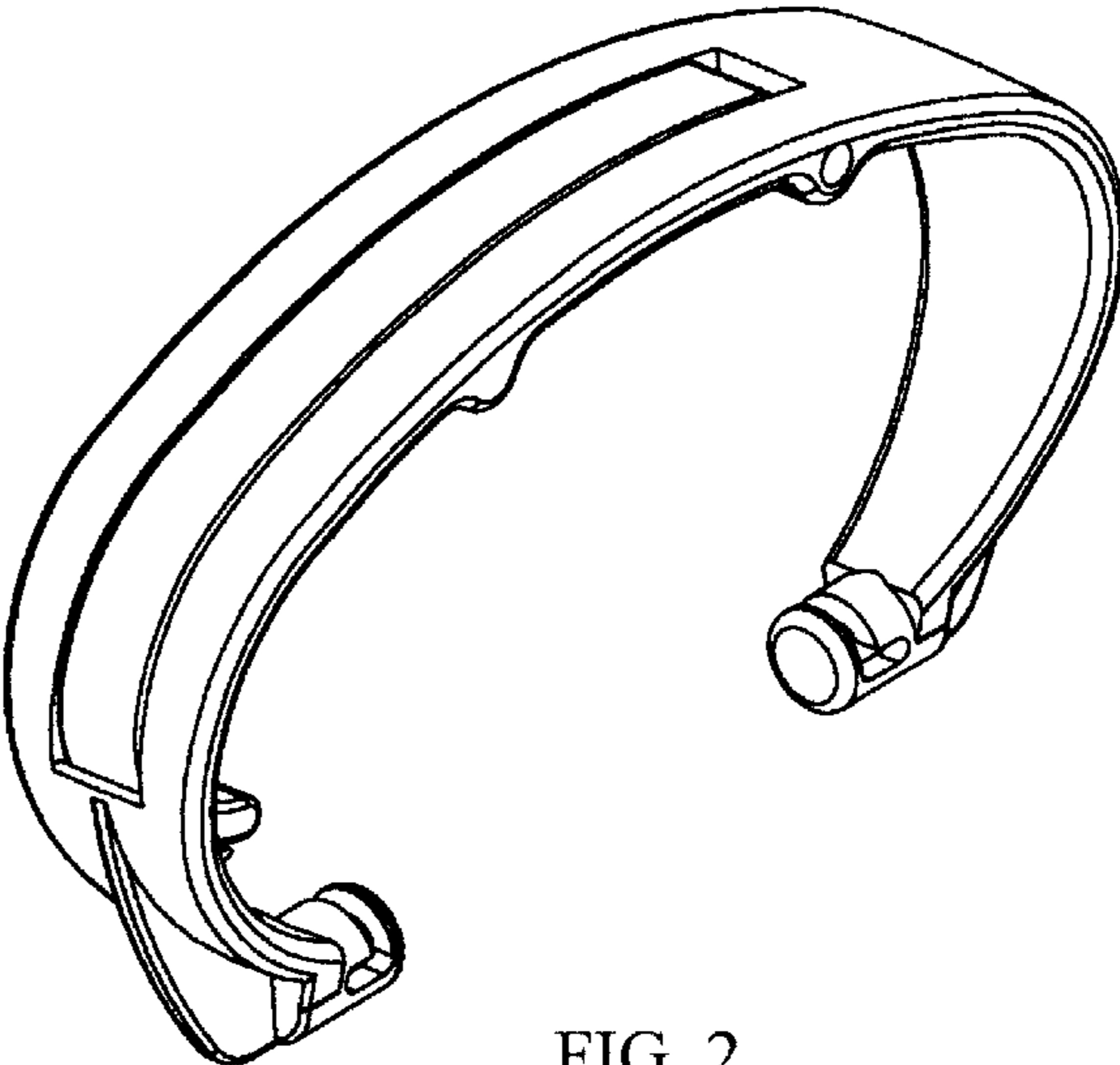

FIG. 2

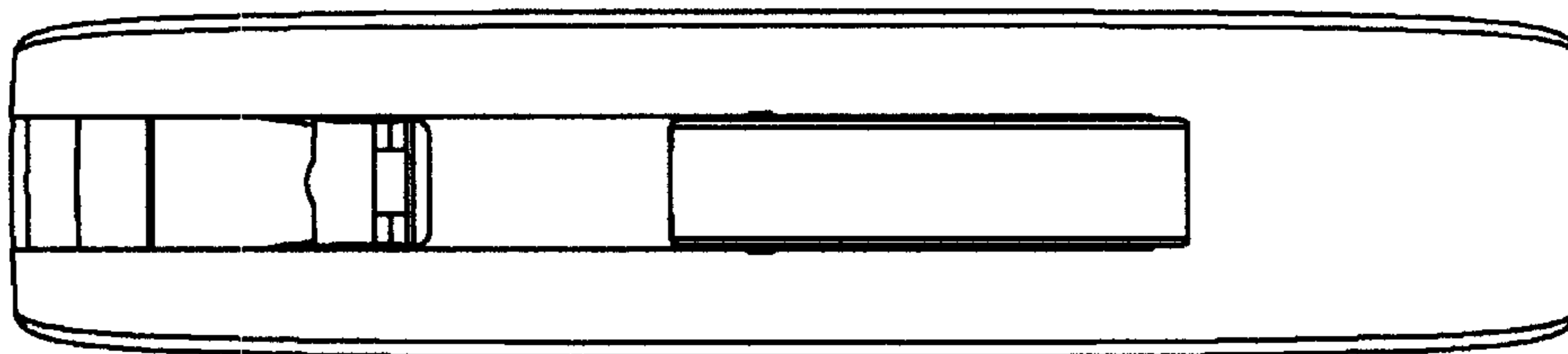

FIG. 3

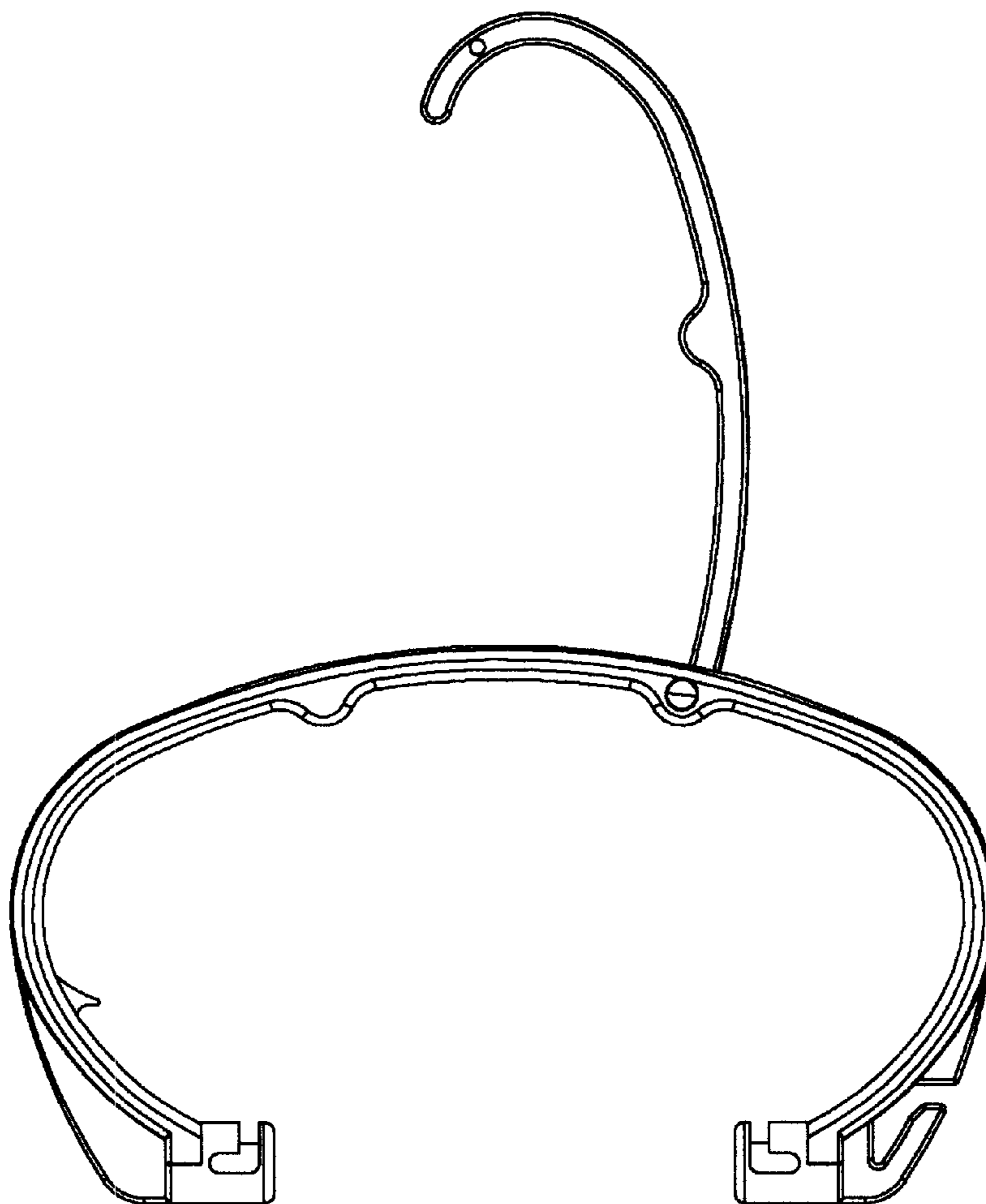

FIG. 4

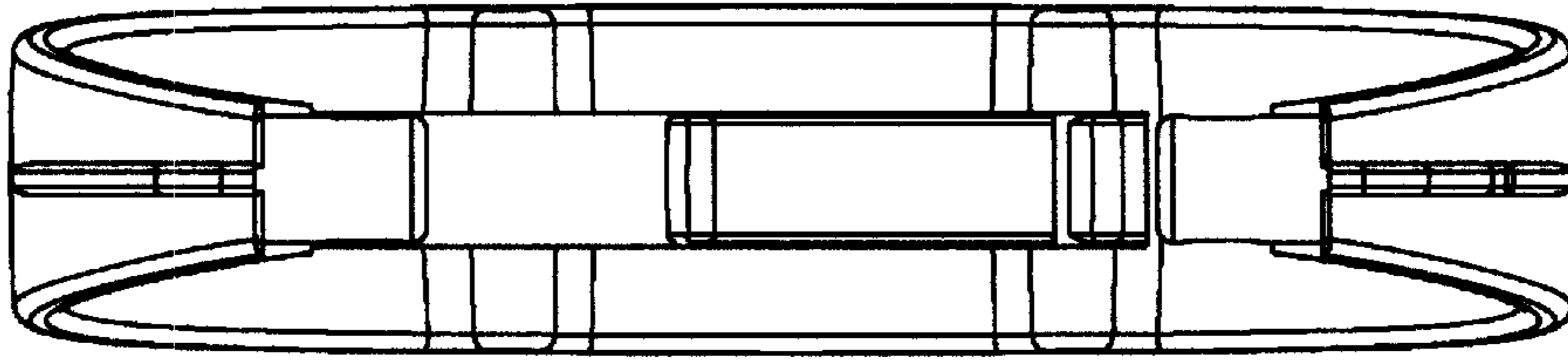

FIG. 5

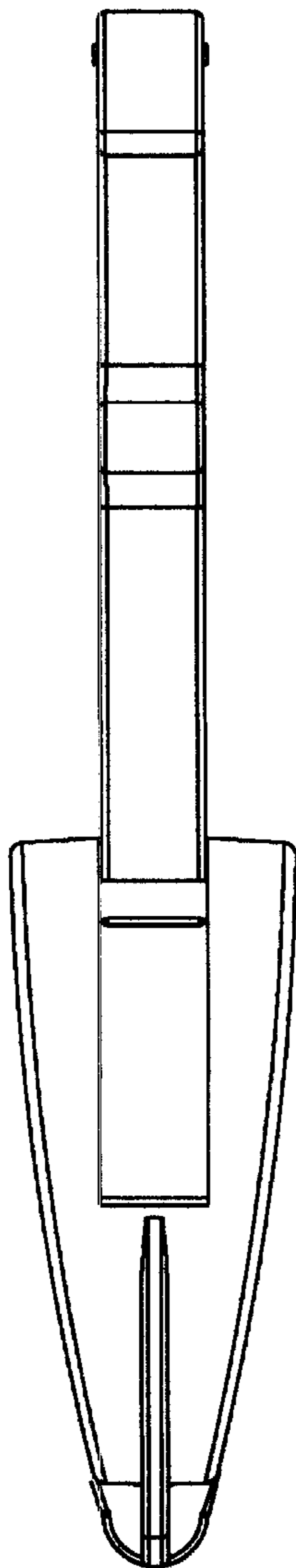

FIG. 6

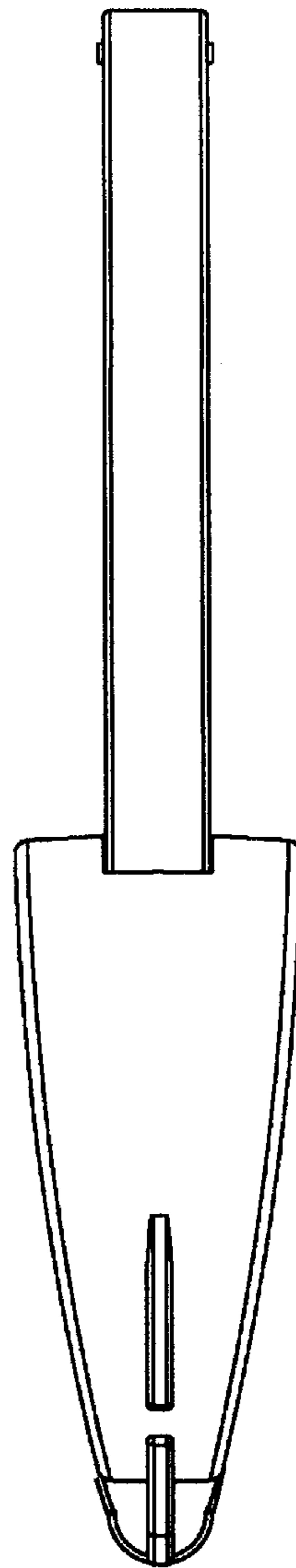

FIG. 7

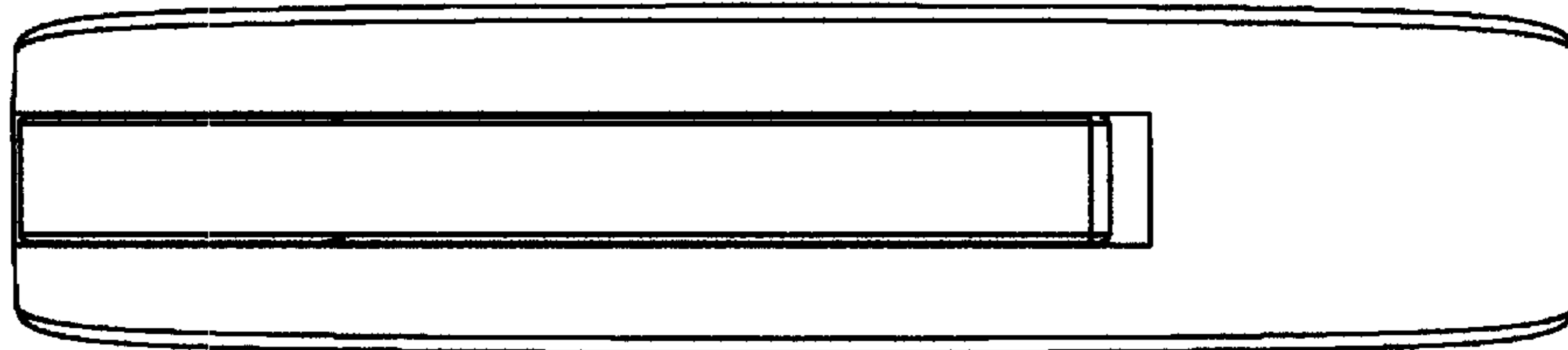

FIG. 8

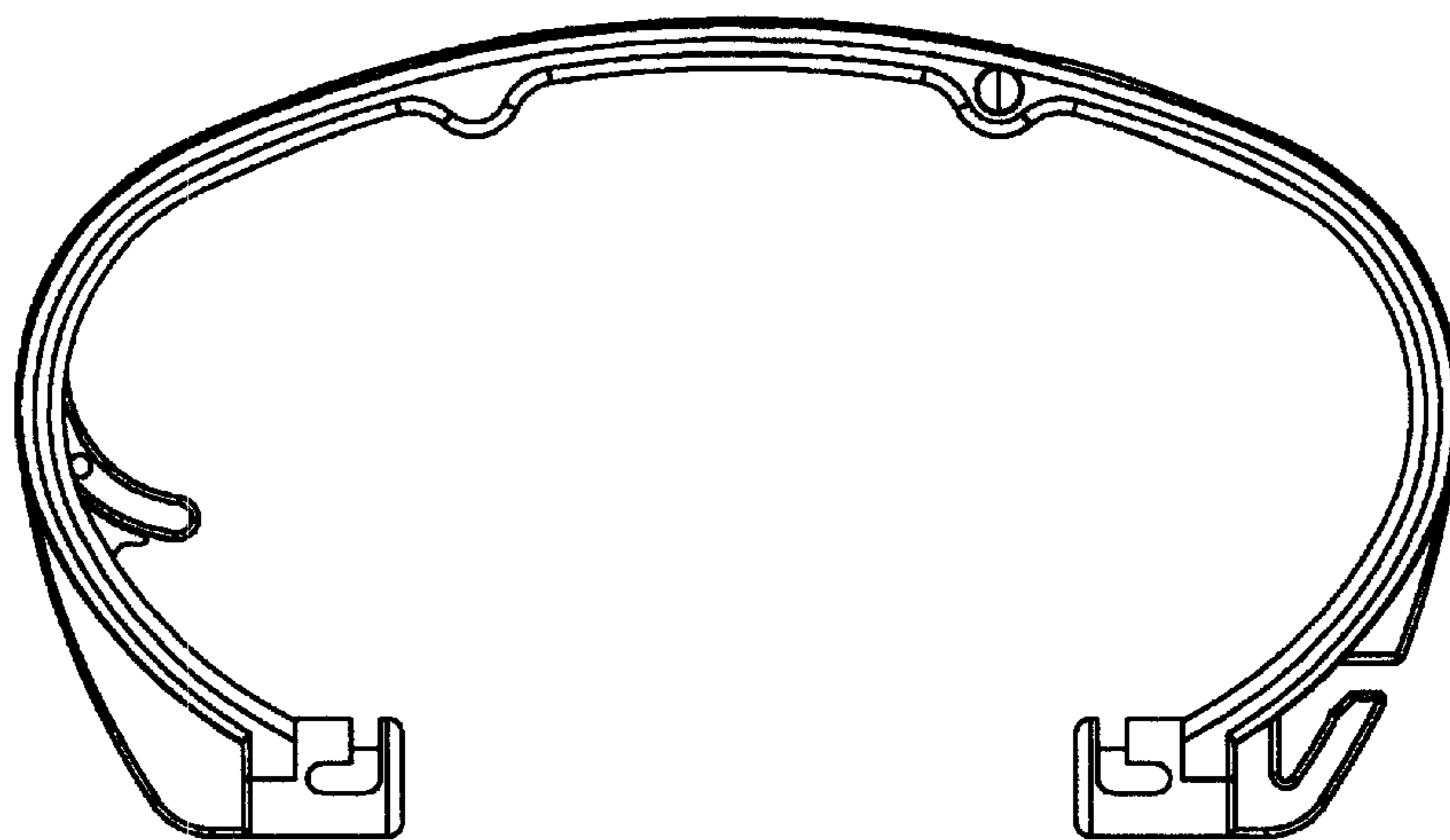

FIG. 9

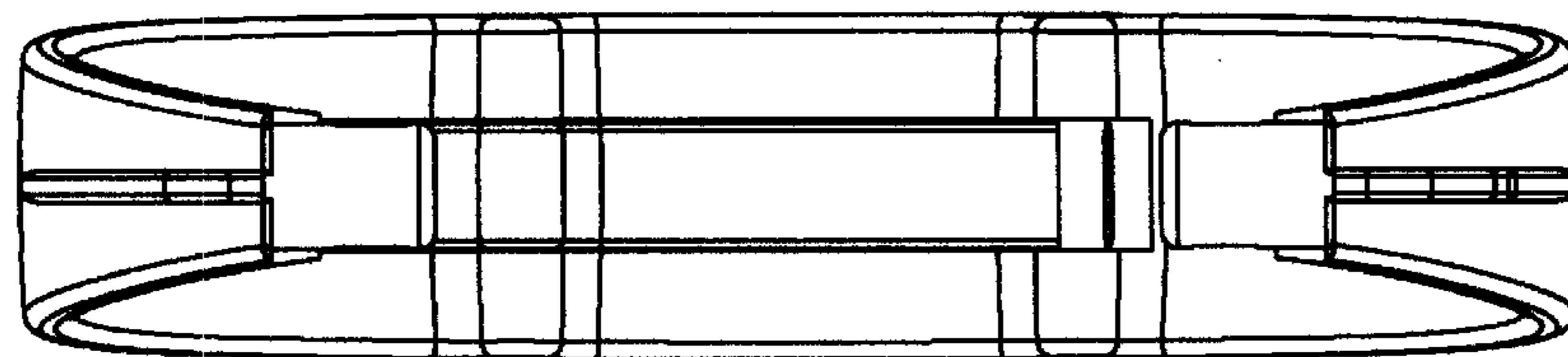

FIG. 10

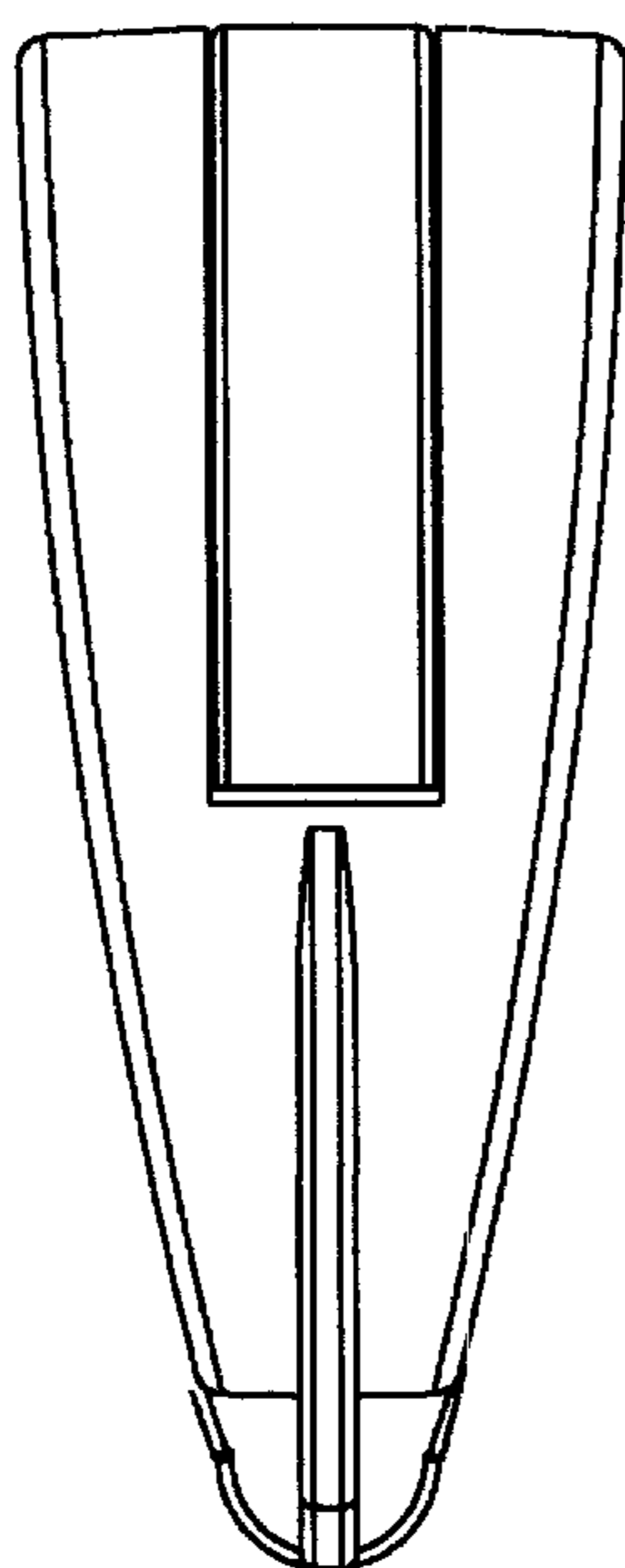

FIG. 11

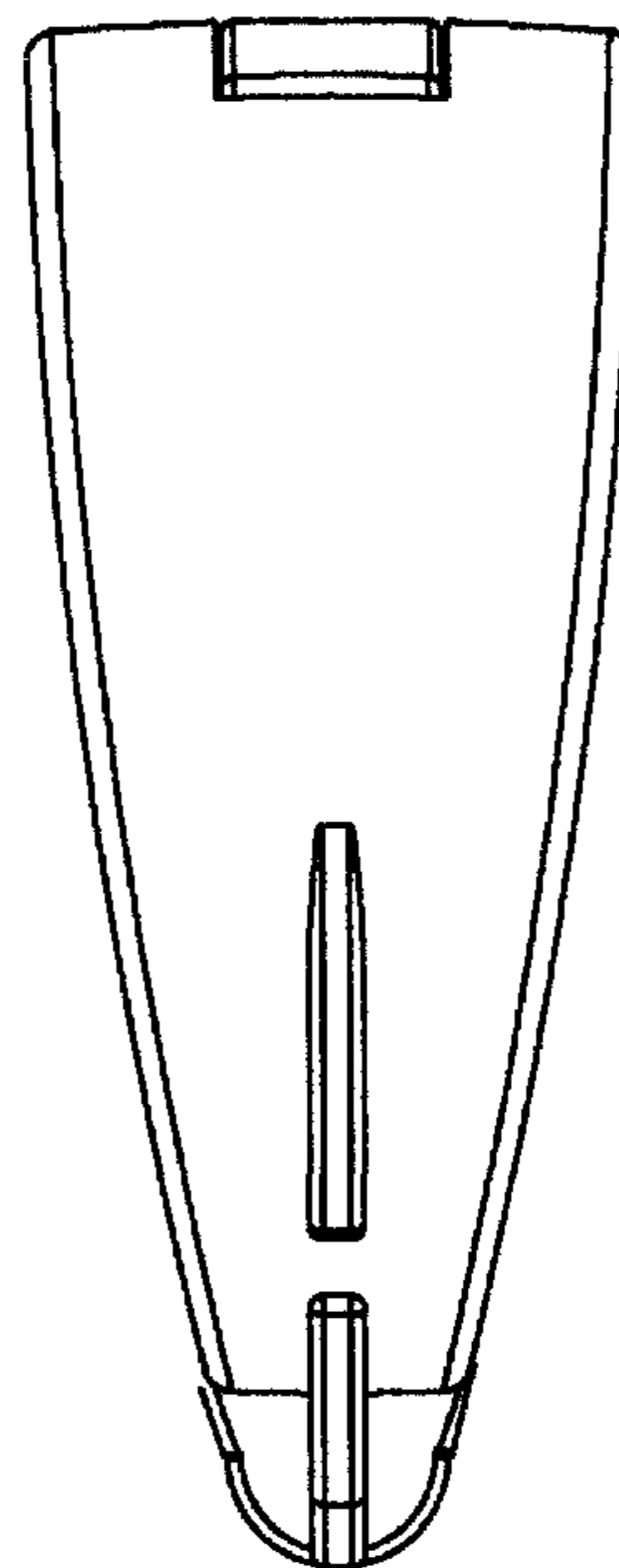

FIG. 12