



US00D530589S

(12) **United States Design Patent**
Wang

(10) **Patent No.:** **US D530,589 S**

(45) **Date of Patent:** **** Oct. 24, 2006**

(54) **HANDLE FOR A PLASTER TROWEL**

(76) Inventor: **See-Tuh Wang**, No. 14, Jhenping St.,
Fusing Township, Changhua County
(TW)

(**) Term: **14 Years**

(21) Appl. No.: **29/231,362**

(22) Filed: **Jun. 6, 2005**

(51) **LOC (8) Cl.** **08-05**

(52) **U.S. Cl.** **D8/107; D8/45**

(58) **Field of Classification Search** D8/107,
D8/45; 15/235.4, 235.6, 235.8; 16/110.1,
16/421, 436; 81/489, 177.1, 20; 294/55
See application file for complete search history.

(56) **References Cited**

U.S. PATENT DOCUMENTS

4,884,312	A	*	12/1989	Clark	15/235.4
5,327,612	A	*	7/1994	Kelsay	15/235.4
5,713,096	A	*	2/1998	Kelsay et al.	15/235.4
D397,021	S	*	8/1998	Hortnagl	D8/107
D442,446	S	*	5/2001	Hortnagl	D8/10
D448,258	S	*	9/2001	Hay et al.	D8/10
D448,265	S	*	9/2001	Chen	D8/80
D465,397	S	*	11/2002	Chen	D8/107
D472,787	S	*	4/2003	Kyte	D8/107
D506,658	S	*	6/2005	Jimenez	D8/45
D508,638	S	*	8/2005	Meyer et al.	D8/10
D509,718	S	*	9/2005	Jimenez	D8/45

D516,887	S	*	3/2006	Miller	D8/45
D519,012	S	*	4/2006	Miller	D8/45
D519,819	S	*	5/2006	Jimenez	D8/107

OTHER PUBLICATIONS

Bon Tool Catalog, 2003, pp. 76 and 77, finishing trowels,
found on google catalogs.*

* cited by examiner

Primary Examiner—Philip S. Hyder

(74) *Attorney, Agent, or Firm*—Egbert Law Offices

(57) **CLAIM**

I claim the ornamental design for a handle for a plaster
trowel, as shown and described.

DESCRIPTION

FIG. 1 is an upper perspective view of the handle for a
plaster trowel showing my design.

FIG. 2 is a front view thereof;

FIG. 3 is a back view thereof;

FIG. 4 is a side view thereof;

FIG. 5 is an opposite side view thereof;

FIG. 6 is a top plan view thereof;

FIG. 7 is a bottom view thereof; and,

FIG. 8 is another perspective view showing attachment to a
trowel.

The dotted lines are presented for illustrative purposes and
form no part of the claimed design.

1 Claim, 5 Drawing Sheets

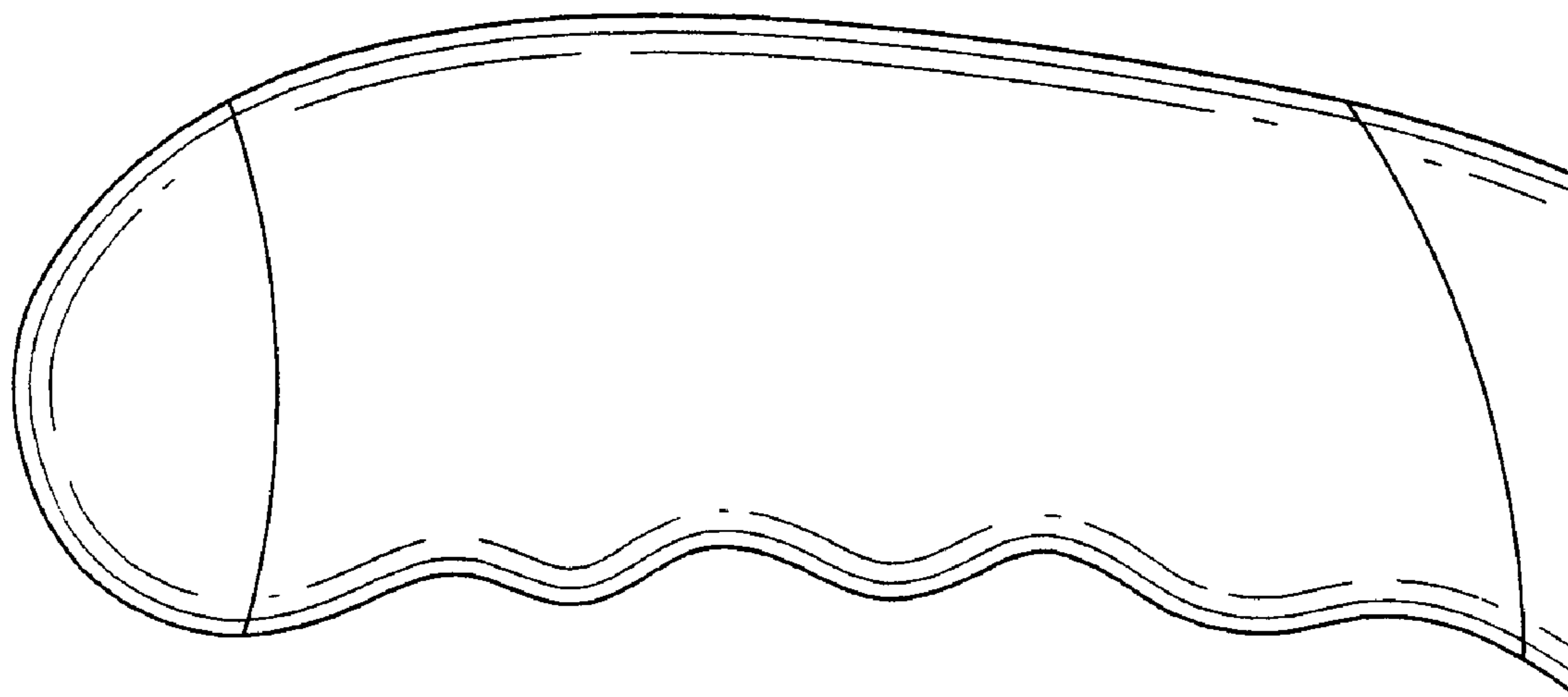

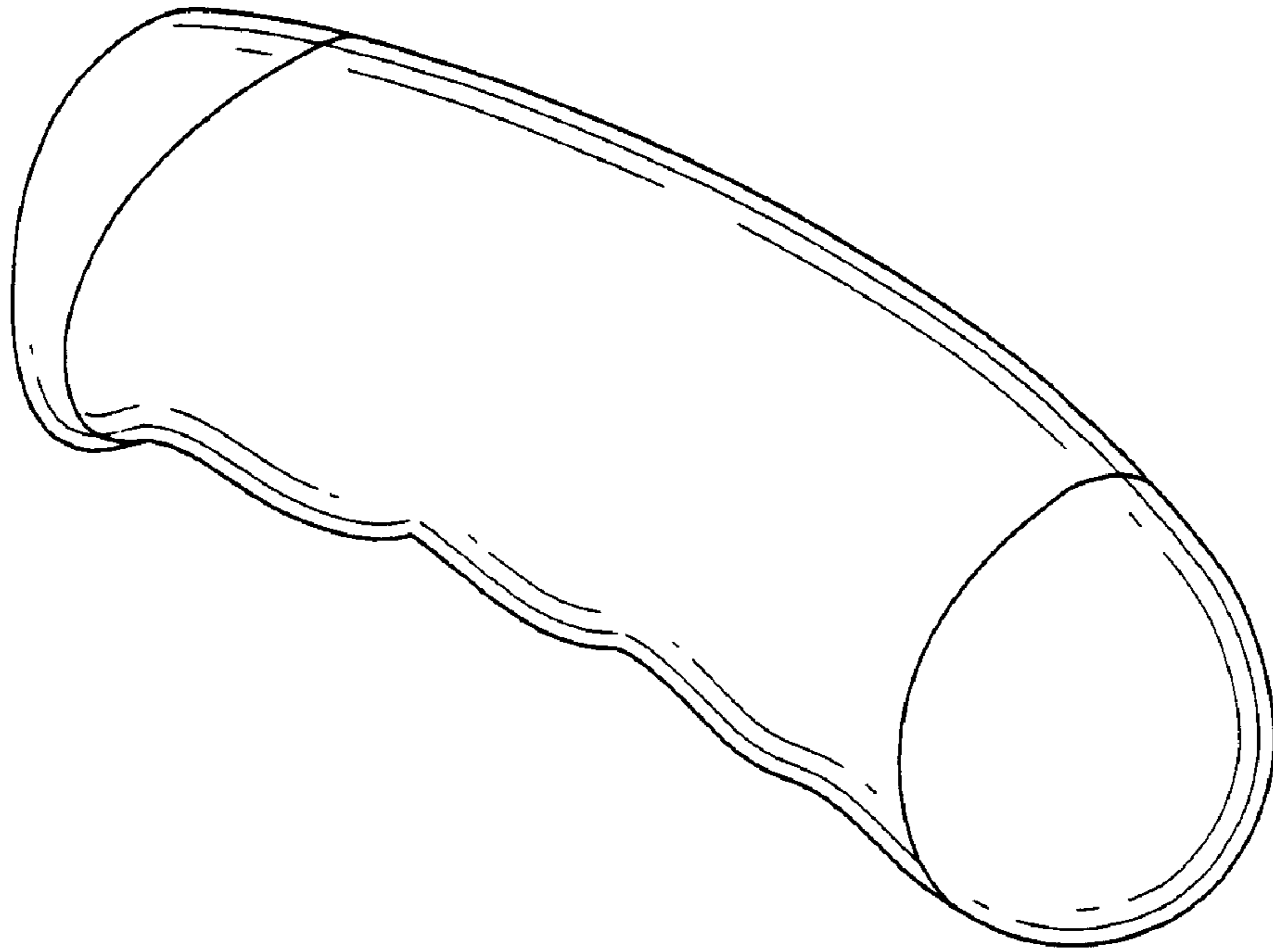

FIG. 1

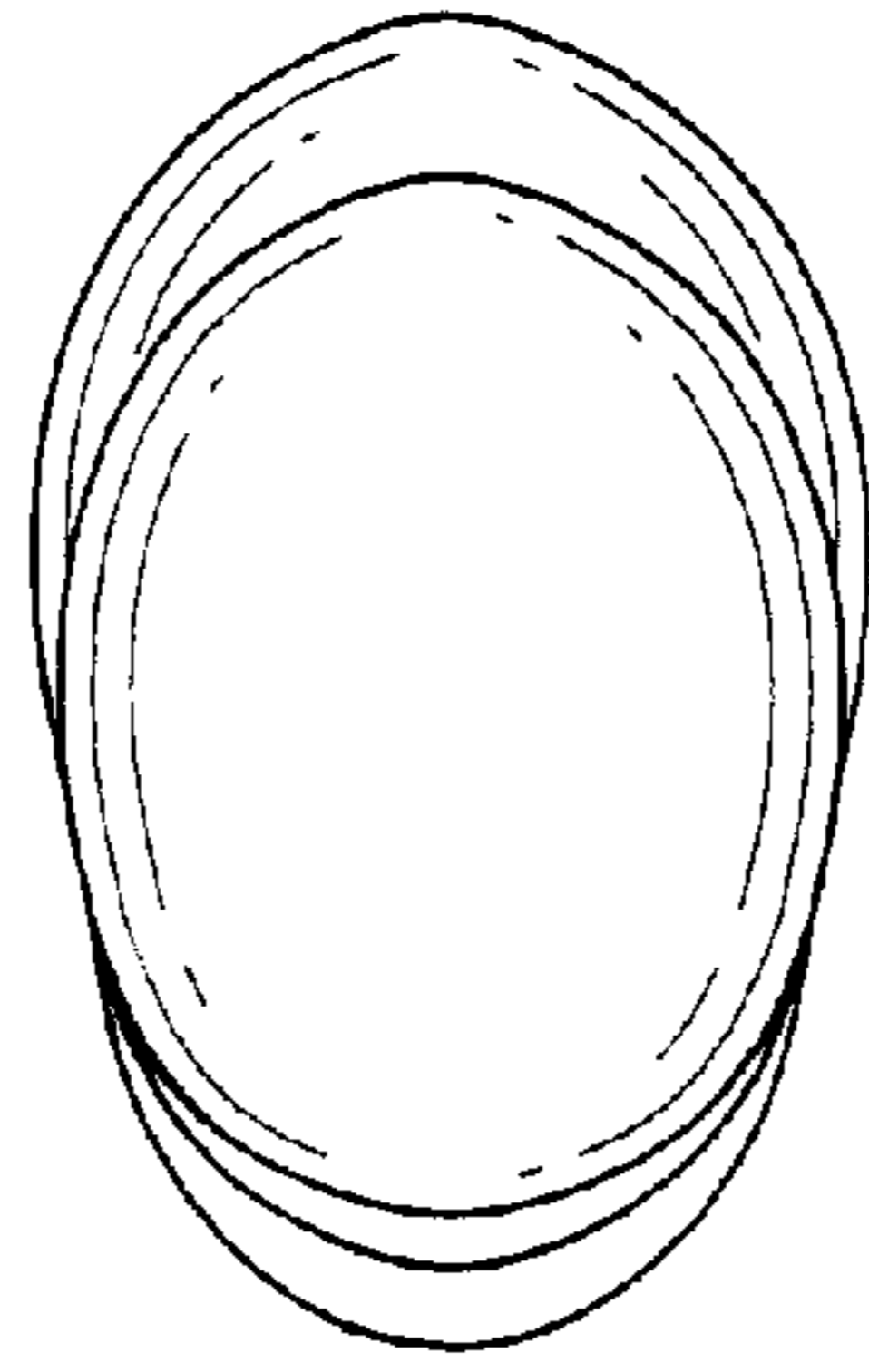

FIG. 2

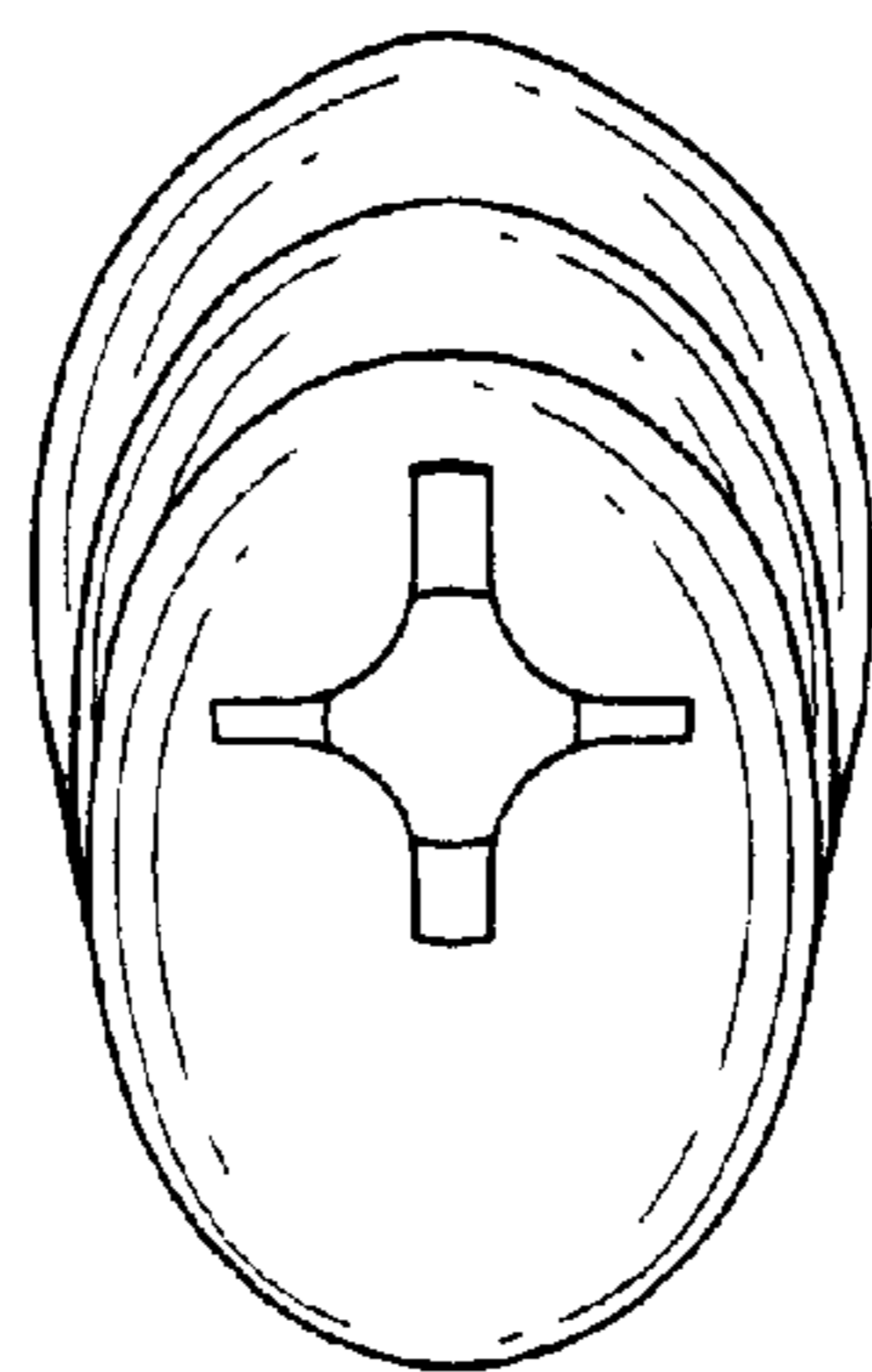

FIG. 3

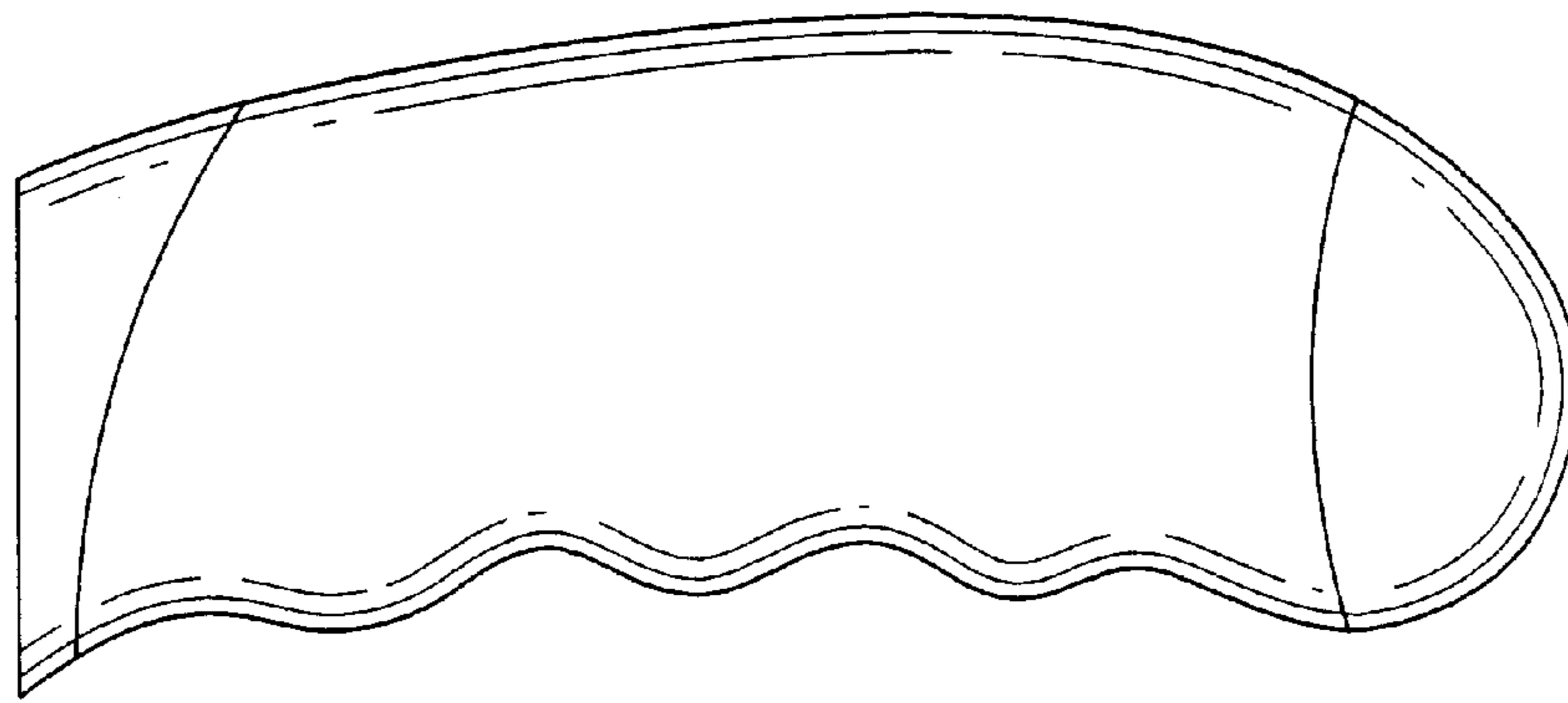

FIG. 4

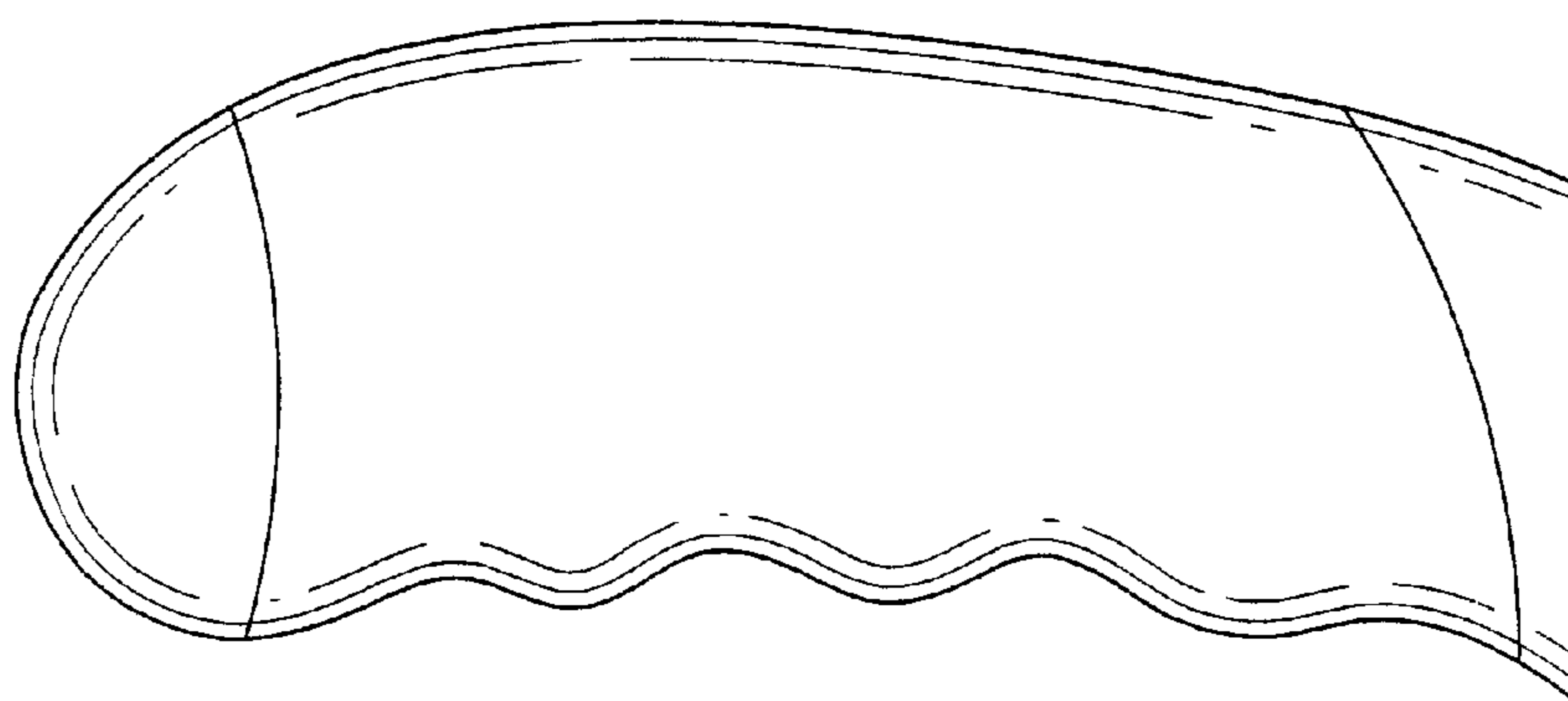

FIG. 5

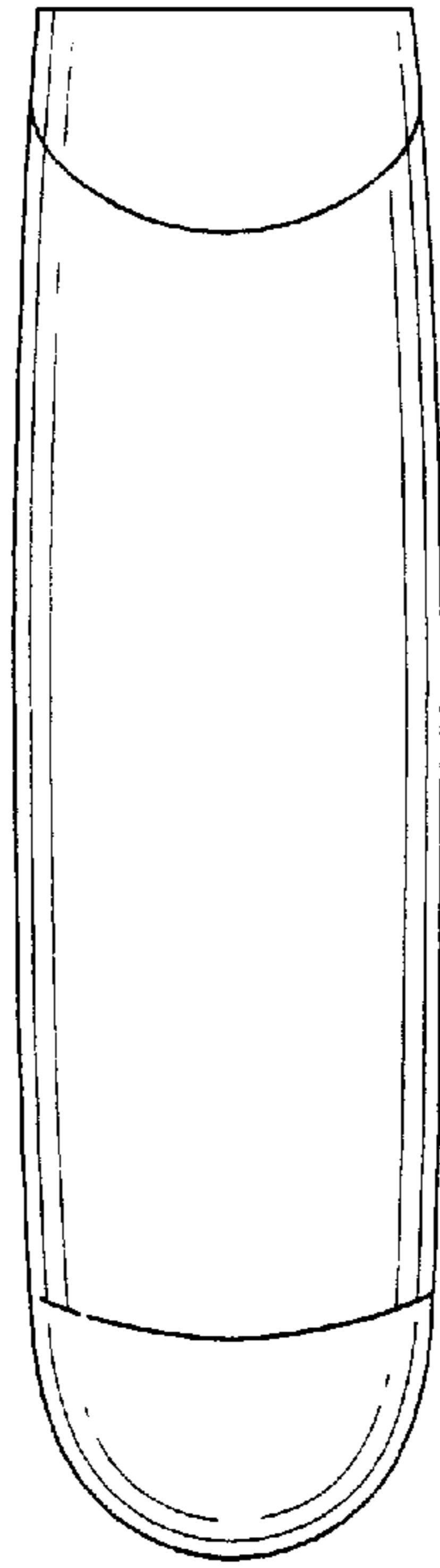

FIG. 6

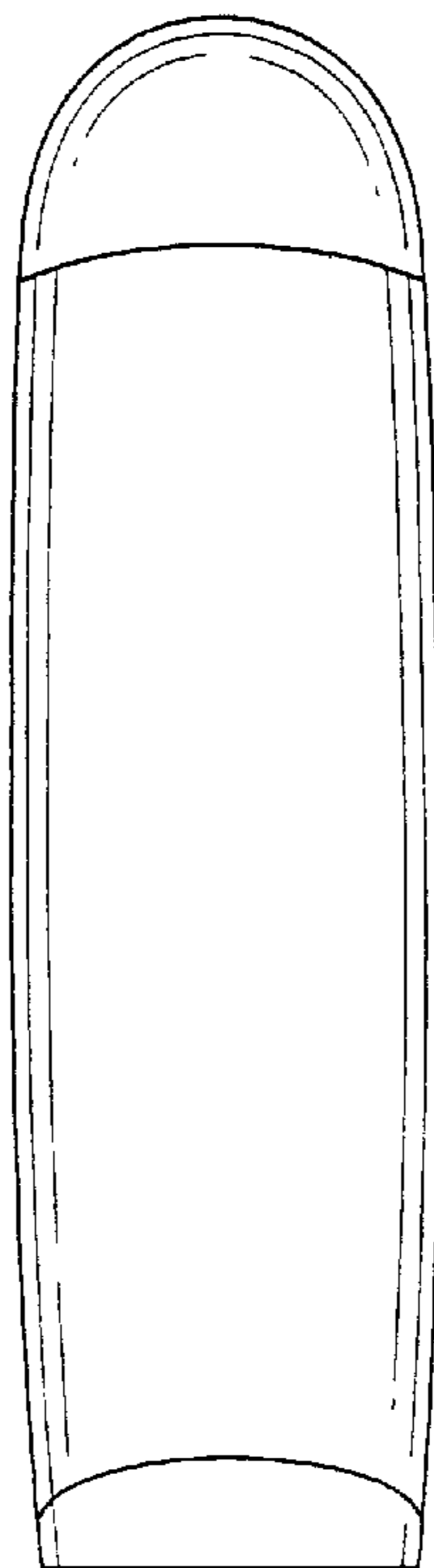

FIG. 7

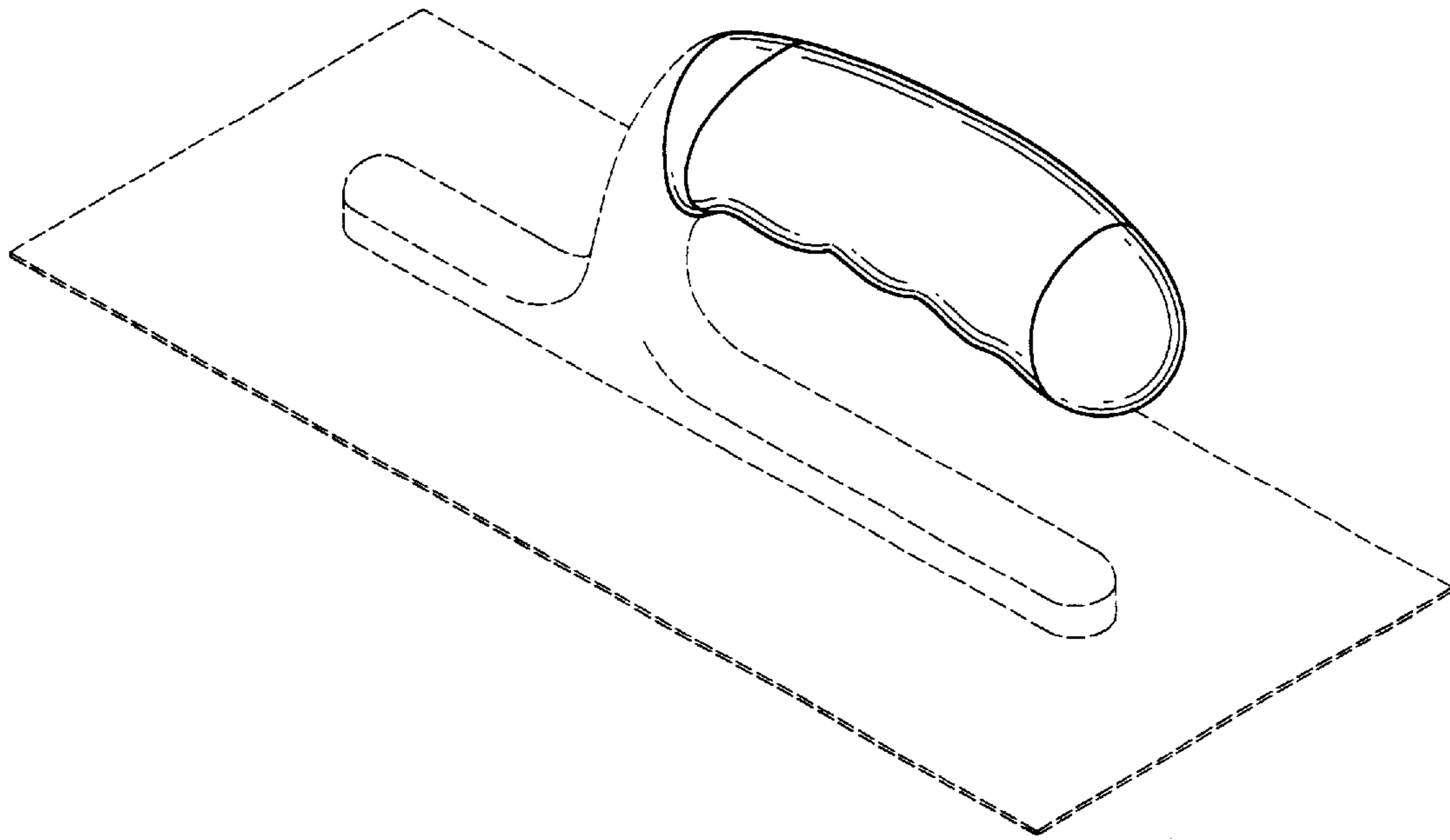

FIG.8