



US00D530574S

(12) **United States Design Patent**  
**Thornton**

(10) **Patent No.:** **US D530,574 S**

(45) **Date of Patent:** **\*\* Oct. 24, 2006**

(54) **CONDIMENT GRINDER**

(75) Inventor: **Andrew John Thornton**, Godalming  
(GB)

(73) Assignee: **William Levene Limited**, Farnborough  
(GB)

(\*\*) Term: **14 Years**

(21) Appl. No.: **29/231,872**

(22) Filed: **Jun. 10, 2005**

(30) **Foreign Application Priority Data**

Dec. 24, 2004 (EM) ..... 000275284-002

(51) **LOC (8) Cl.** ..... **07-04**

(52) **U.S. Cl.** ..... **D7/679**

(58) **Field of Classification Search** ..... D7/679,  
D7/590-597, 372-374, 383, 384; 241/168,  
241/169, 169.1, 273.1-273.5, 262, 286  
See application file for complete search history.

(56) **References Cited**

**U.S. PATENT DOCUMENTS**

5,988,543 A \* 11/1999 Wu ..... 241/168

D437,744 S \* 2/2001 Young et al. .... D7/679  
D451,351 S \* 12/2001 Young et al. .... D7/679  
6,877,684 B1 \* 4/2005 Wu ..... 241/169.1

\* cited by examiner

*Primary Examiner*—Terry A. Wallace

(74) *Attorney, Agent, or Firm*—Reed Smith LLP

(57) **CLAIM**

The ornamental design for a condiment grinder, as shown and described.

**DESCRIPTION**

FIG. 1 is a front elevational view of the condiment grinder.  
FIG. 2 is a back elevational view of the FIG. 1 device.  
FIG. 3 is a first side elevational view of the FIG. 1 device.  
FIG. 4 is a second side elevational view of the FIG. 1 device.  
FIG. 5 is a top view of the FIG. 1 device; and,  
FIG. 6 is a bottom view of the FIG. 1 device.

**1 Claim, 6 Drawing Sheets**

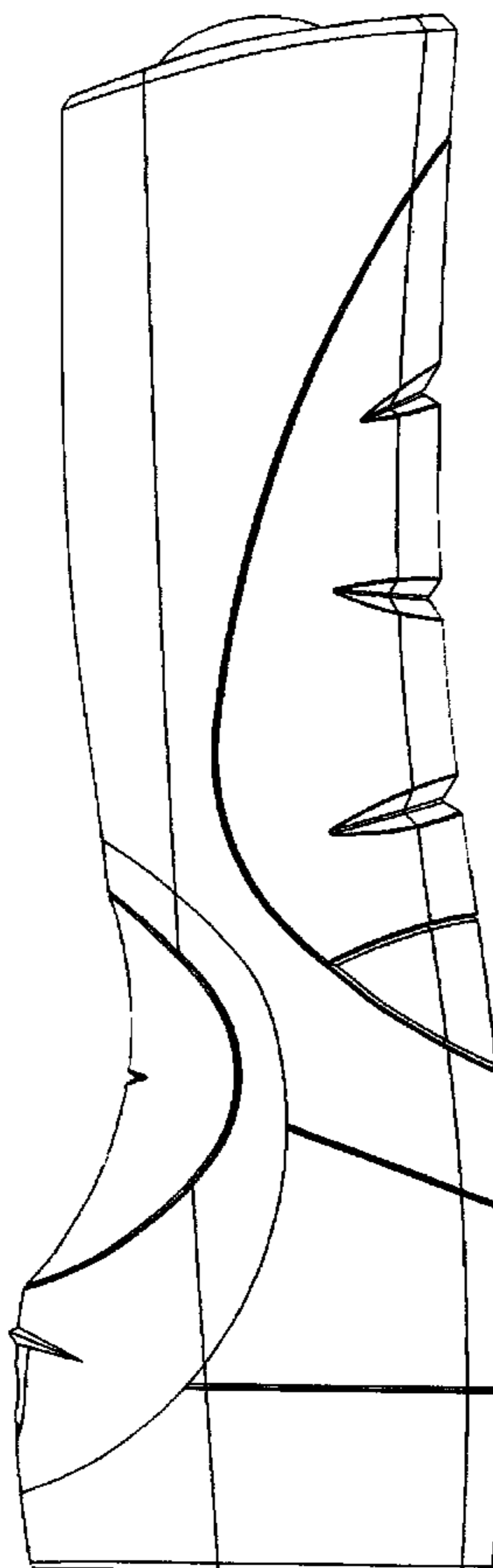

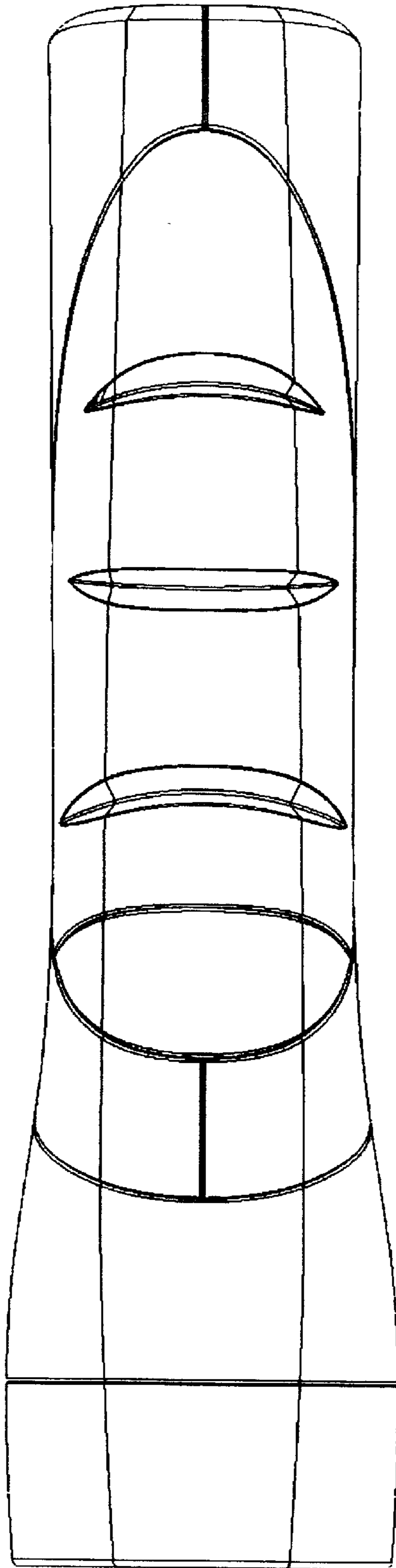

FIG. 1

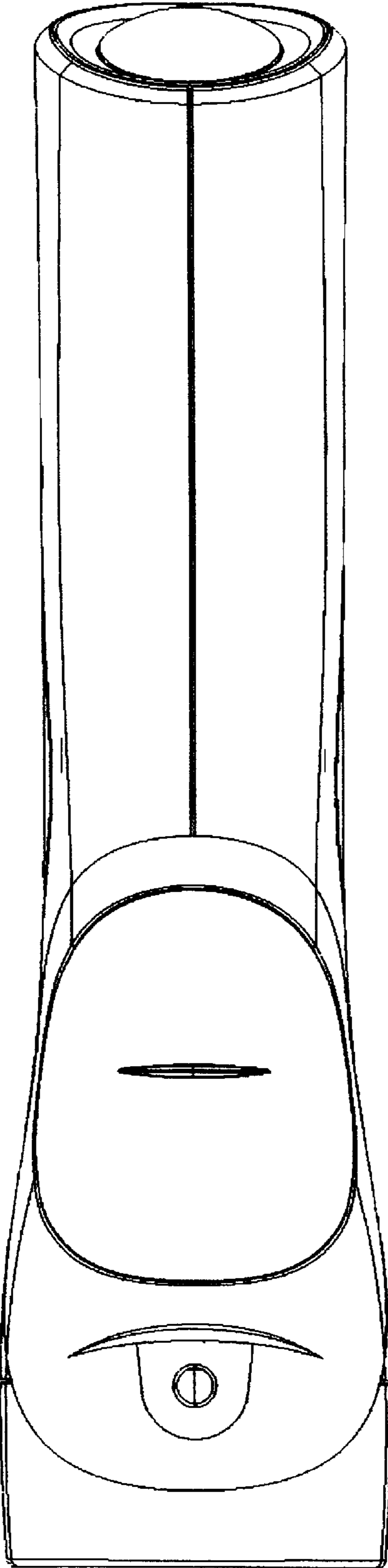

FIG. 2

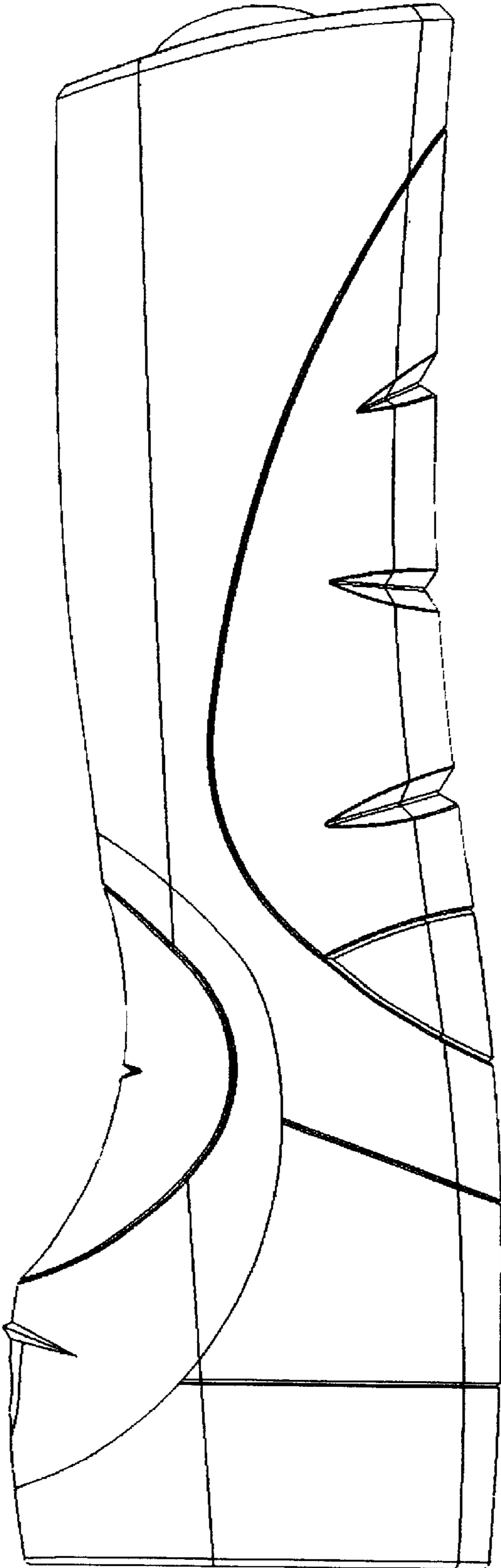

FIG. 3

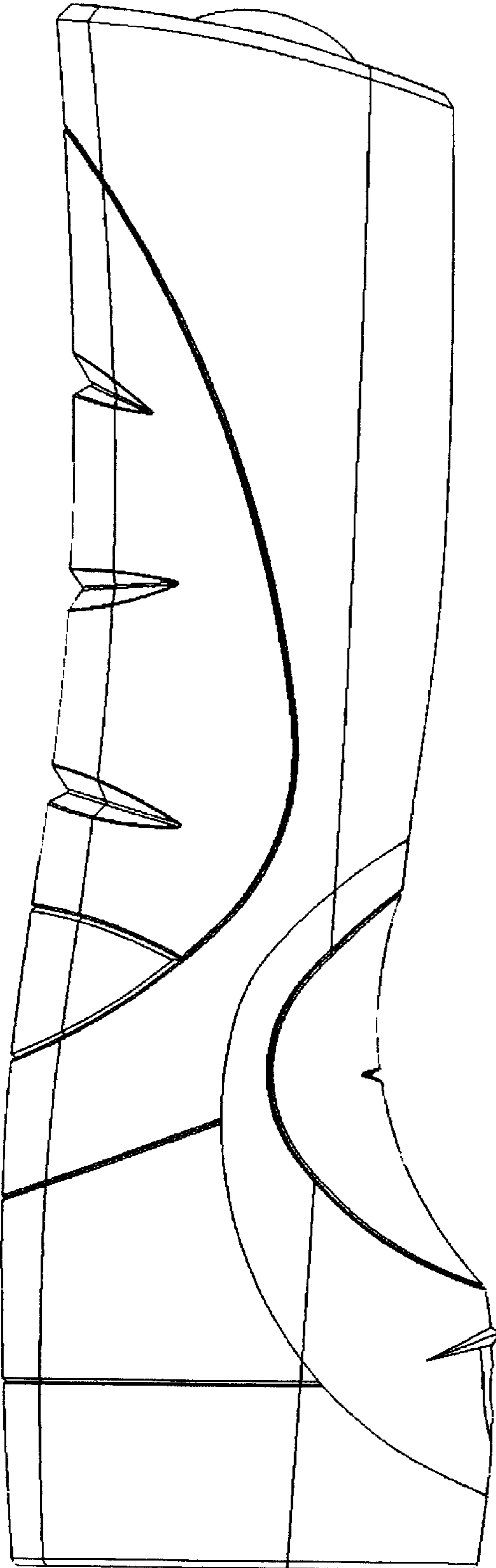

FIG. 4

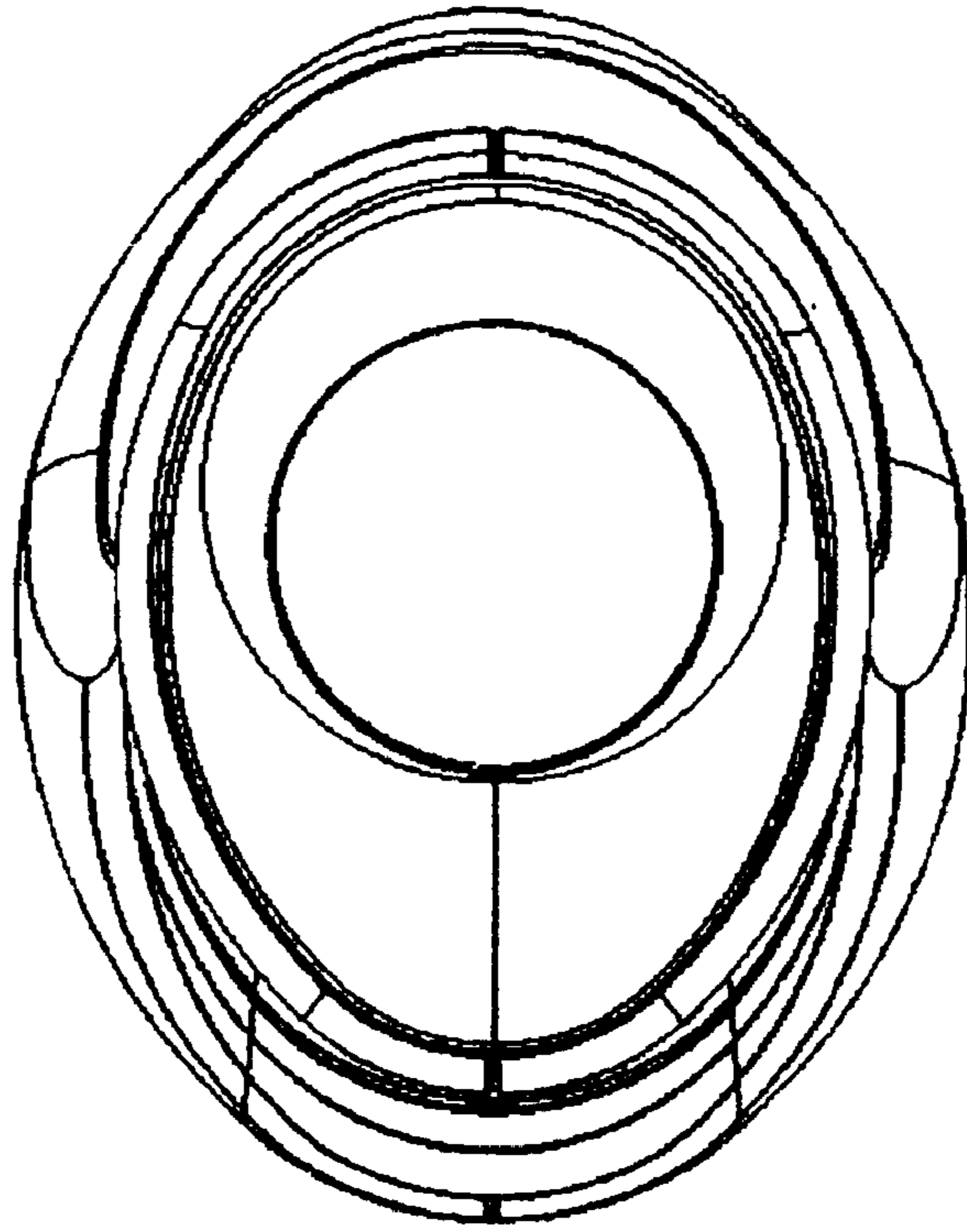

FIG. 5

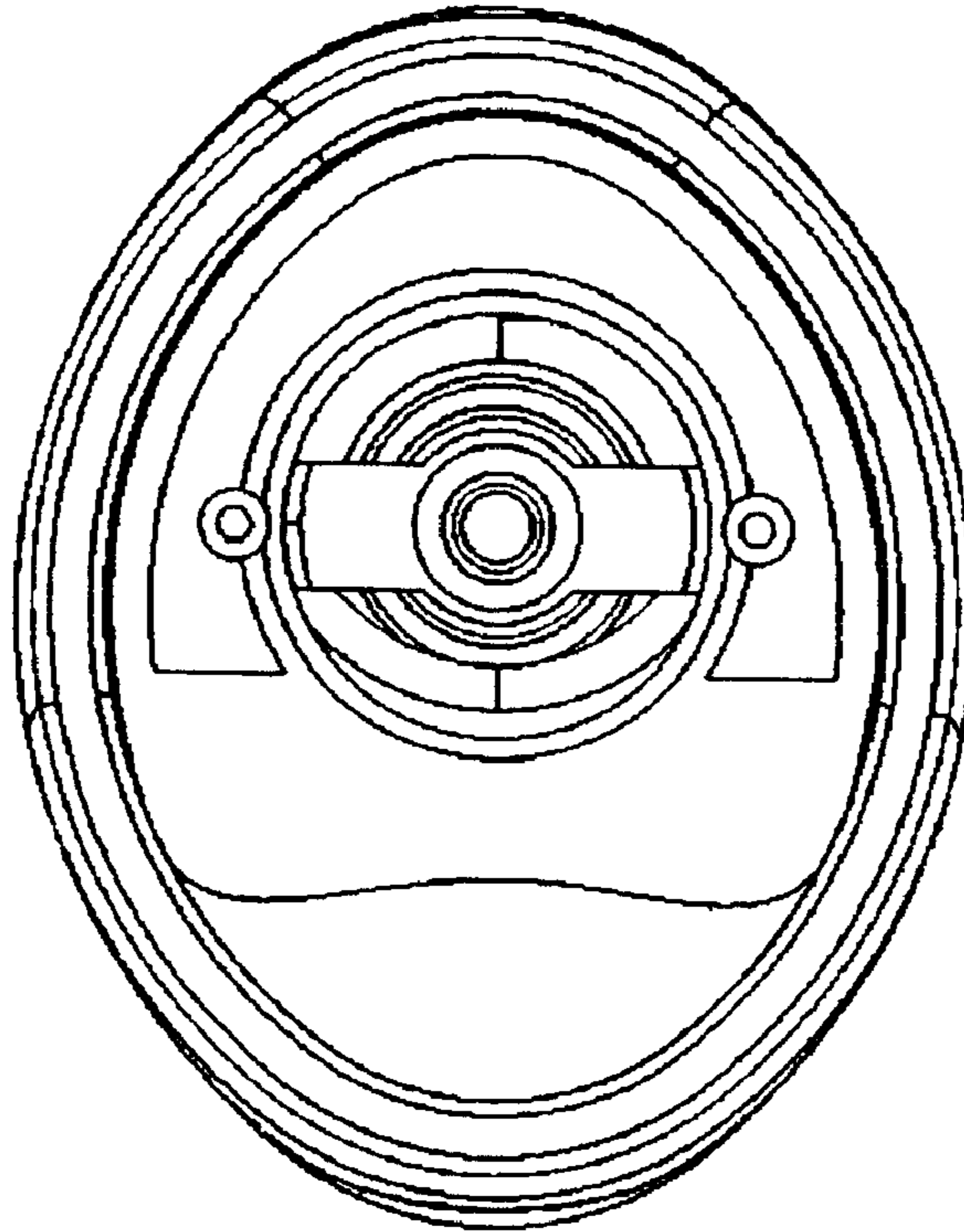

FIG. 6