



US00D530422S

(12) **United States Design Patent**  
**Morris**

(10) **Patent No.:** **US D530,422 S**

(45) **Date of Patent:** **\*\* Oct. 17, 2006**

(54) **ILM FULL VIEW FORCEPS**

(75) Inventor: **Robert Morris**, Birmingham, AL (US)

(73) Assignee: **Synergetics, Inc.**, O'Fallon, MO (US)

(\*\*) Term: **14 Years**

(21) Appl. No.: **29/215,707**

(22) Filed: **Oct. 22, 2004**

(51) **LOC (8) Cl.** ..... **24-02**

(52) **U.S. Cl.** ..... **D24/150**

(58) **Field of Classification Search** ..... D24/150,  
D24/145, 143, 133; D28/55; 606/205-207,  
606/166, 170, 174, 105, 45, 29; 604/22; 433/159  
See application file for complete search history.

(56) **References Cited**

U.S. PATENT DOCUMENTS

D452,936 S	*	1/2002	Grisoni	.....	D28/55
2003/0195480 A1	*	10/2003	Morris	.....	604/272
2003/0229976 A1	*	12/2003	Scheller et al.	.....	29/17.2

\* cited by examiner

*Primary Examiner*—Antoine D. Davis

*Assistant Examiner*—Christopher Lee

(74) *Attorney, Agent, or Firm*—Kevin L. Klug

(57) **CLAIM**

The ornamental design for an ILM full view forceps, as shown and described.

**DESCRIPTION**

FIG. 1 is a left perspective view of an ILM full view forceps showing my new design;

FIG. 2 is a top plan view thereof;

FIG. 3 is a left side view thereof, the right side view being the same thereto;

FIG. 4 is a bottom plan view thereof;

FIG. 5 is an enlarged fragmentary left perspective view of the tip portion thereof;

FIG. 6 is an enlarged fragmentary top plan view of the tip portion thereof;

FIG. 7 is an enlarged fragmentary left side view of the tip portion thereof, the right side view being the same thereto;

FIG. 8 is an enlarged fragmentary bottom plan view of the tip portion thereof;

FIG. 9 is an enlarged front side view of the ILM full view forceps;

FIG. 10 is an enlarged rear side view thereof.

FIG. 11 is left perspective view of an ILM full view forceps in an open position showing my new design;

FIG. 12 is a top plan view thereof;

FIG. 13 is a left side view thereof, the right side view being the same thereto;

FIG. 14 is a bottom plan view thereof;

FIG. 15 is an enlarged fragmentary left perspective view of the tip portion thereof;

FIG. 16 is an enlarged fragmentary top plan view of the tip portion thereof;

FIG. 17 is an enlarged fragmentary left side view of the tip portion thereof, the right side view being the same thereto;

FIG. 18 is an enlarged fragmentary bottom plan view of the tip portion thereof;

FIG. 19 is an enlarged front side view of the ILM full view forceps in an open position; and

FIG. 20 is an enlarged rear side view thereof.

**1 Claim, 10 Drawing Sheets**

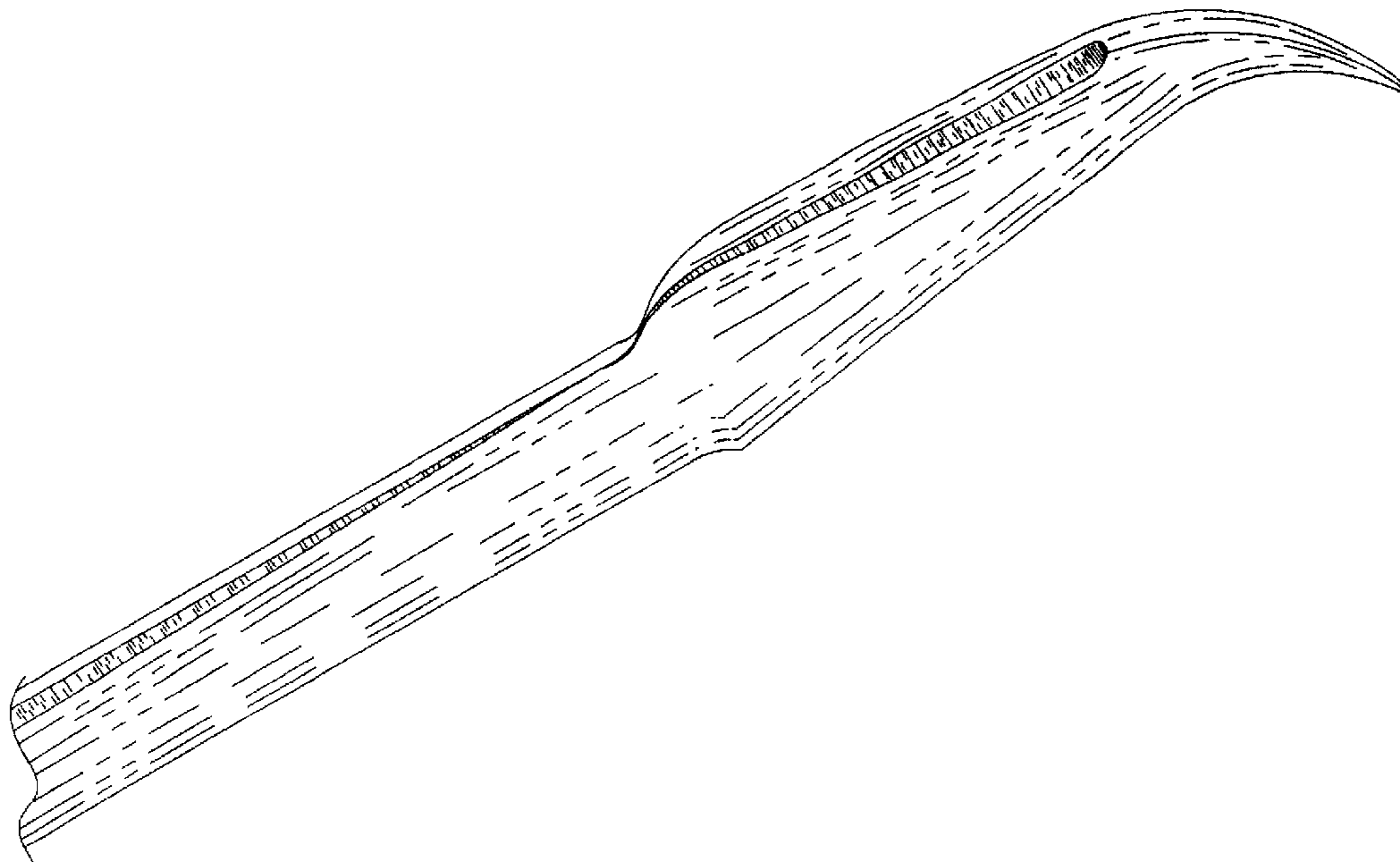

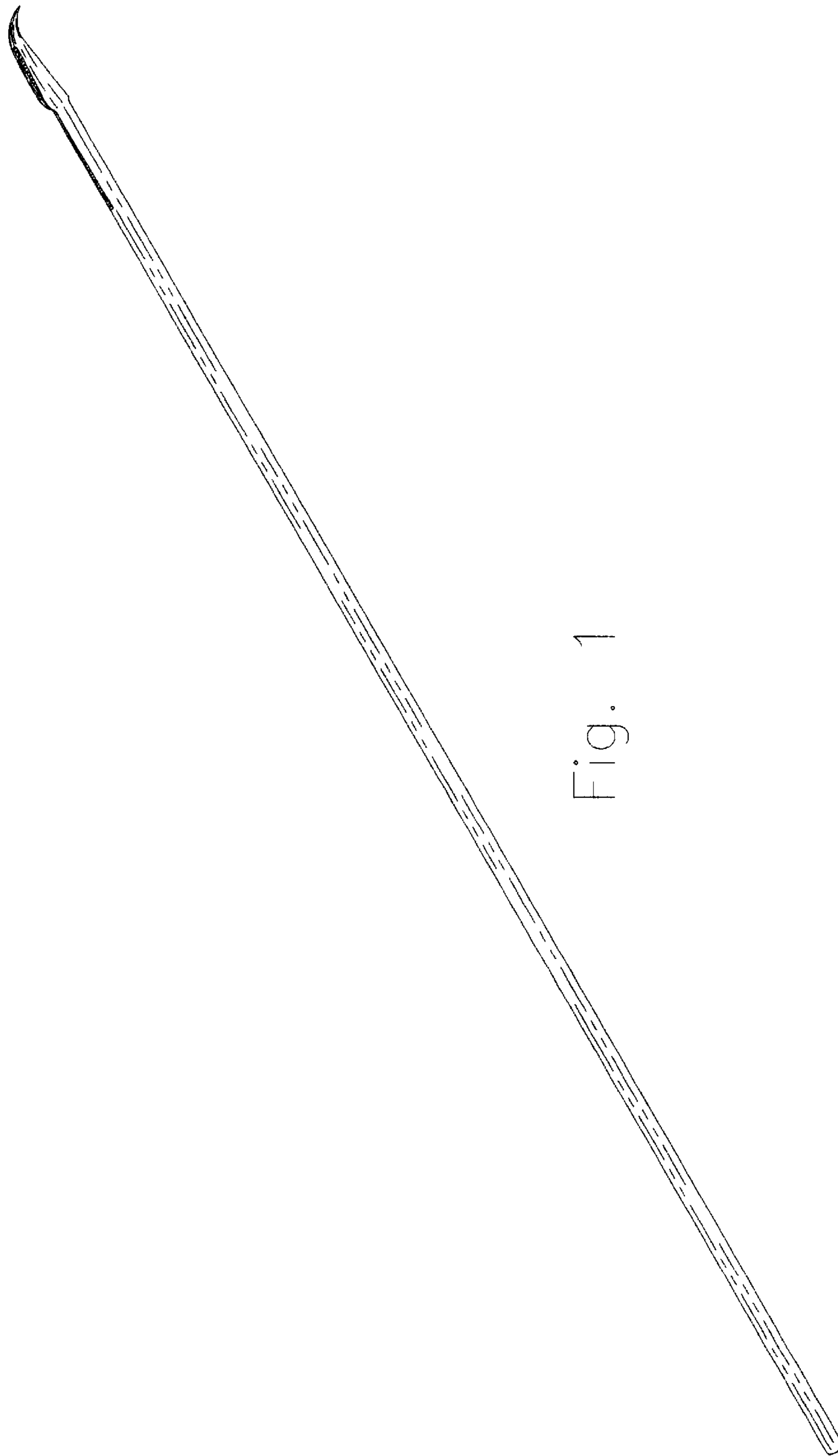

Fig. 1



Fig. 2

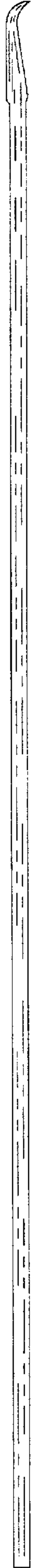

Fig. 3



Fig. 4

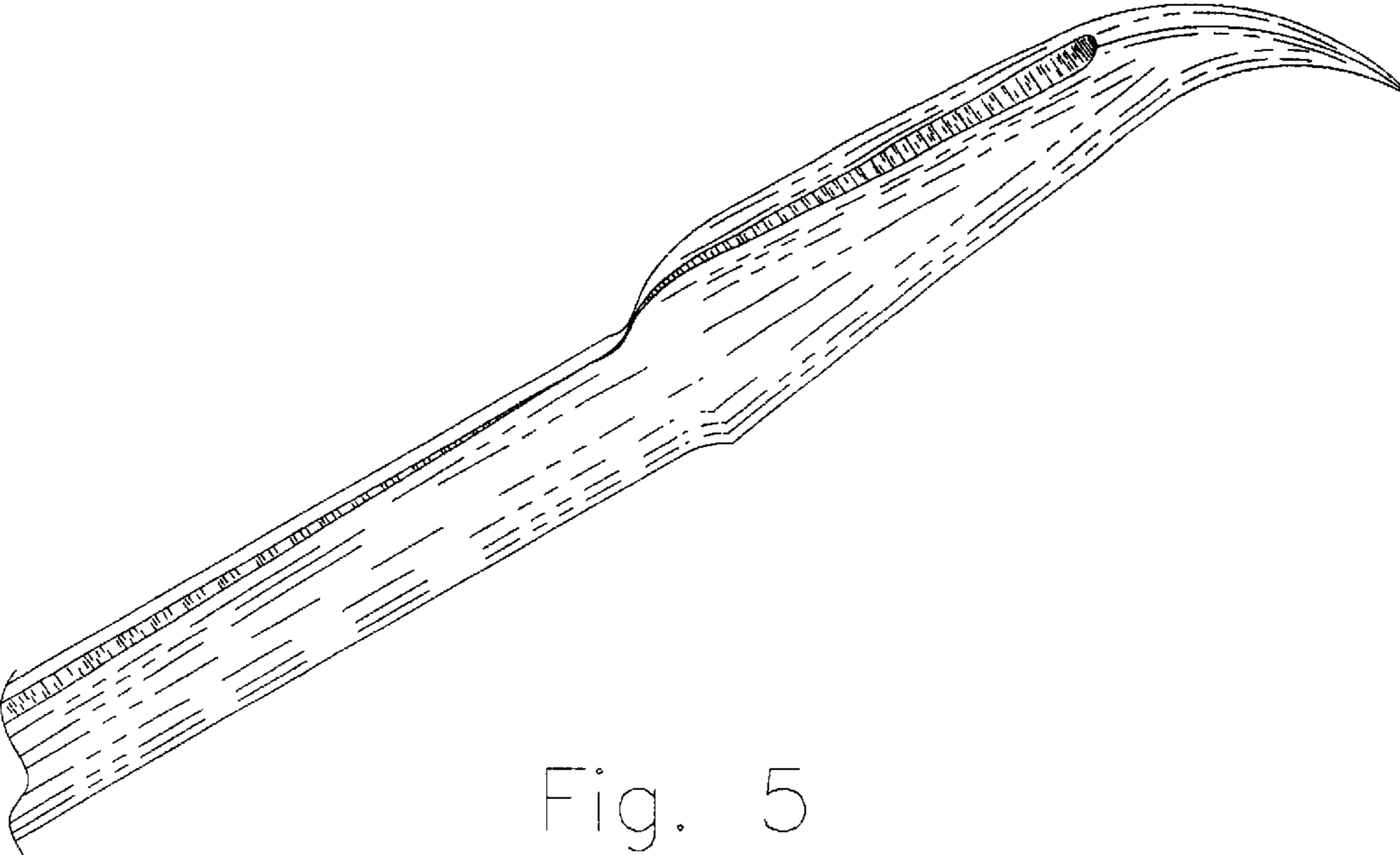

Fig. 5

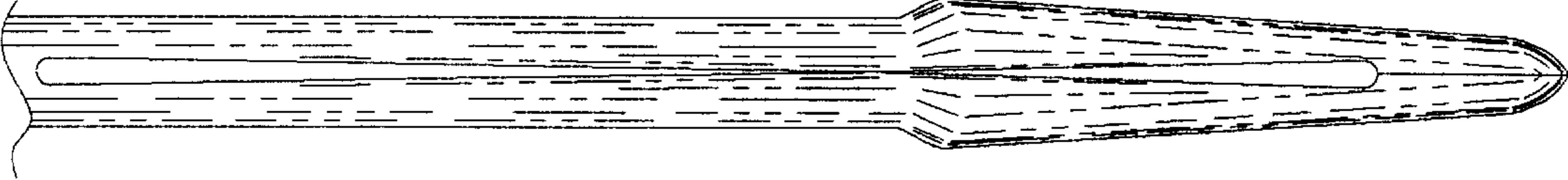

Fig. 6

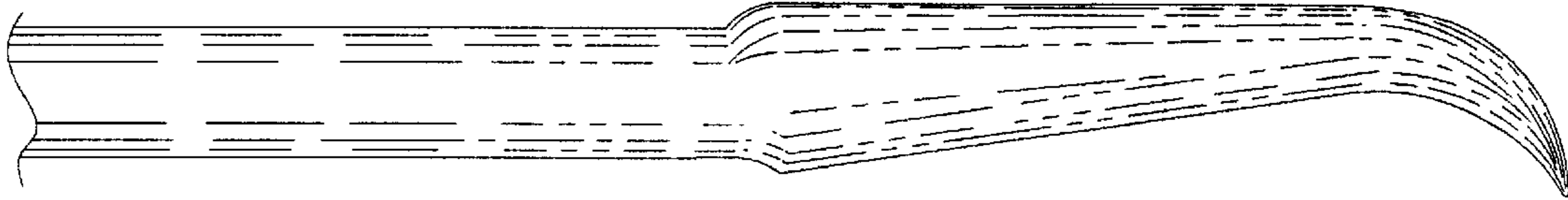

Fig. 7

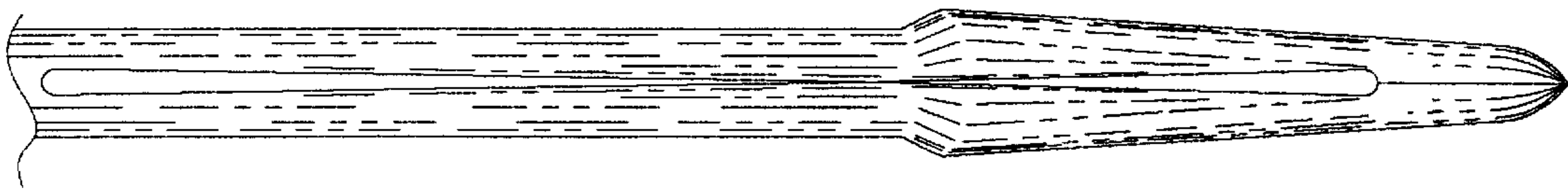

Fig. 8

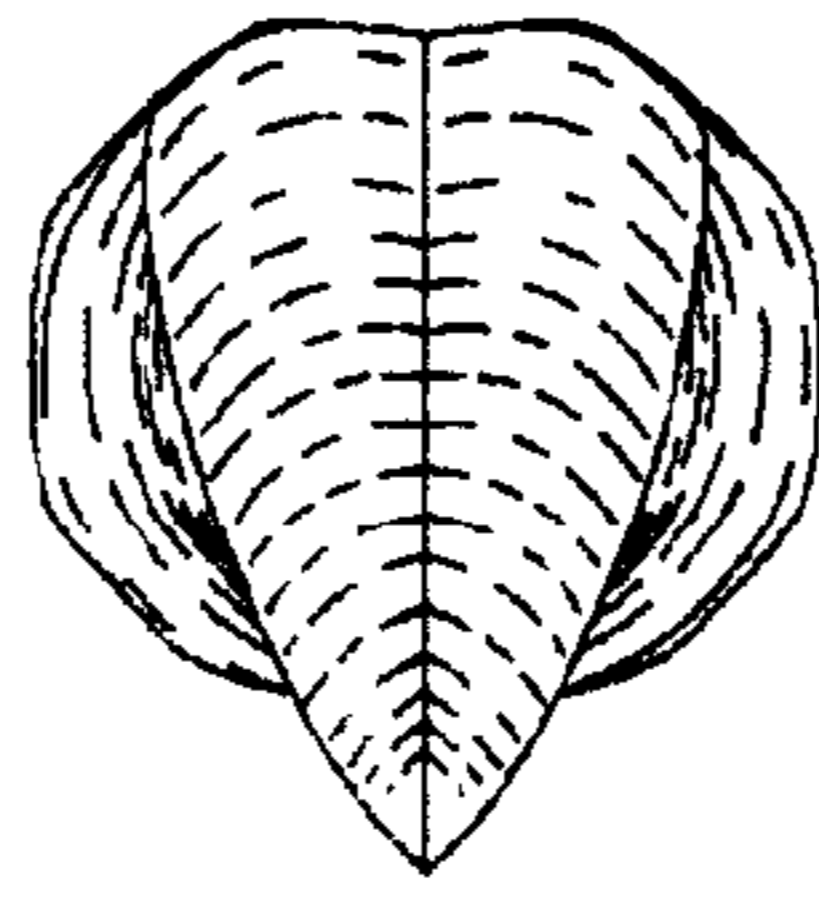

Fig. 9

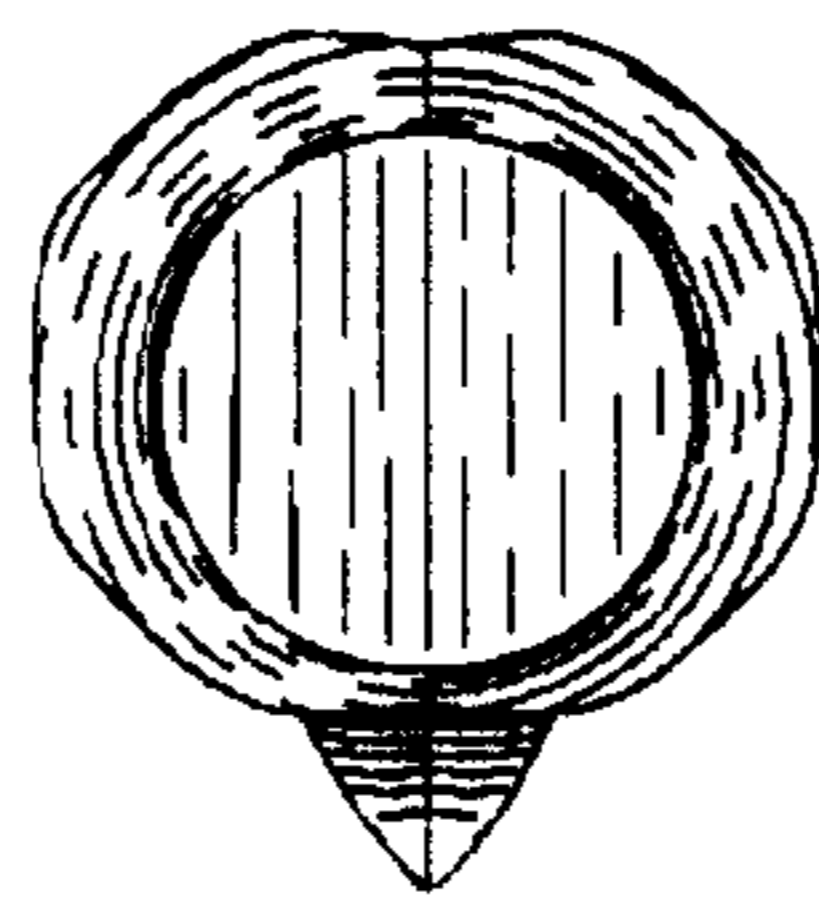

Fig. 10

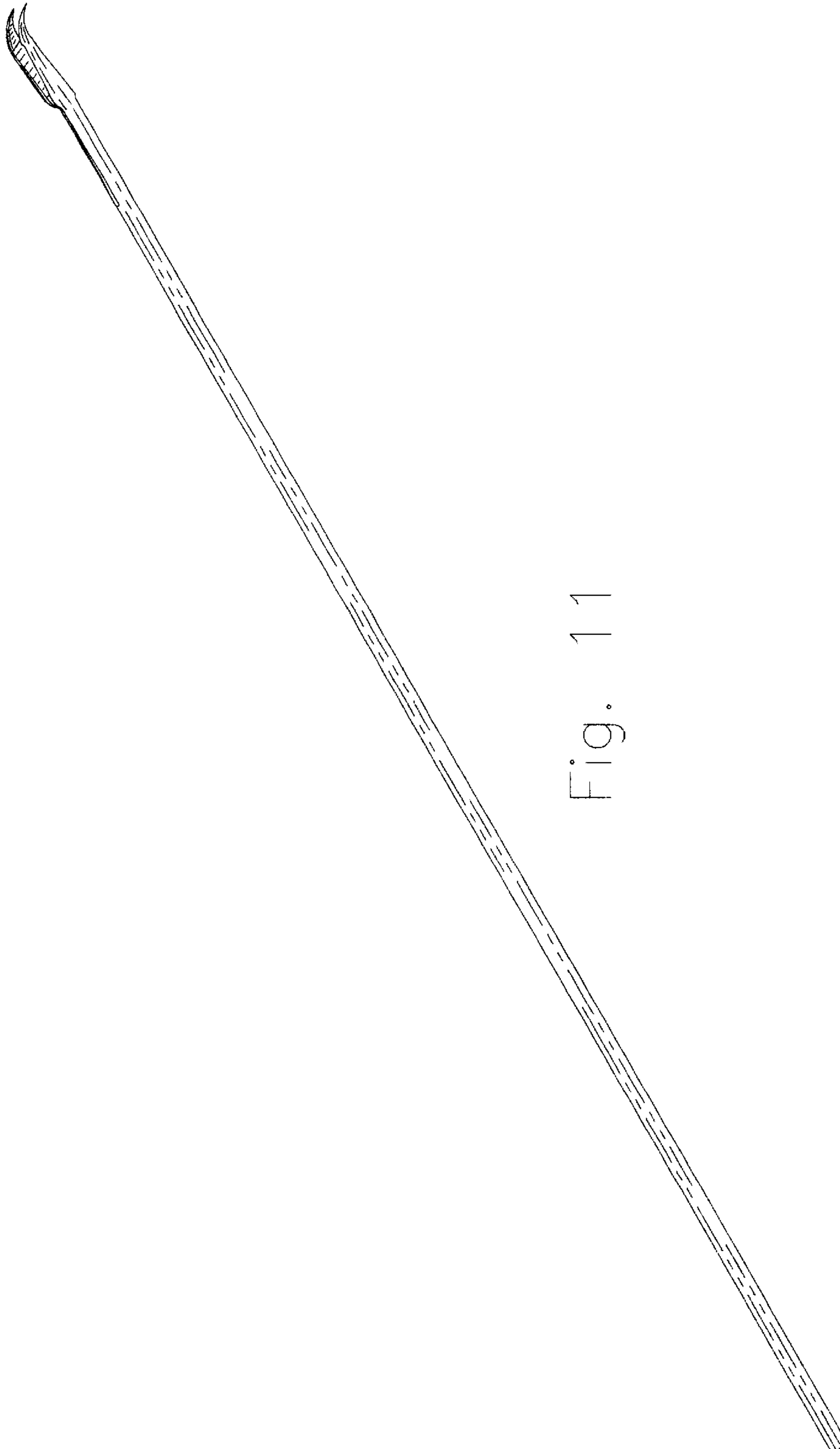

Fig. 11



Fig. 12



Fig. 13



Fig. 14



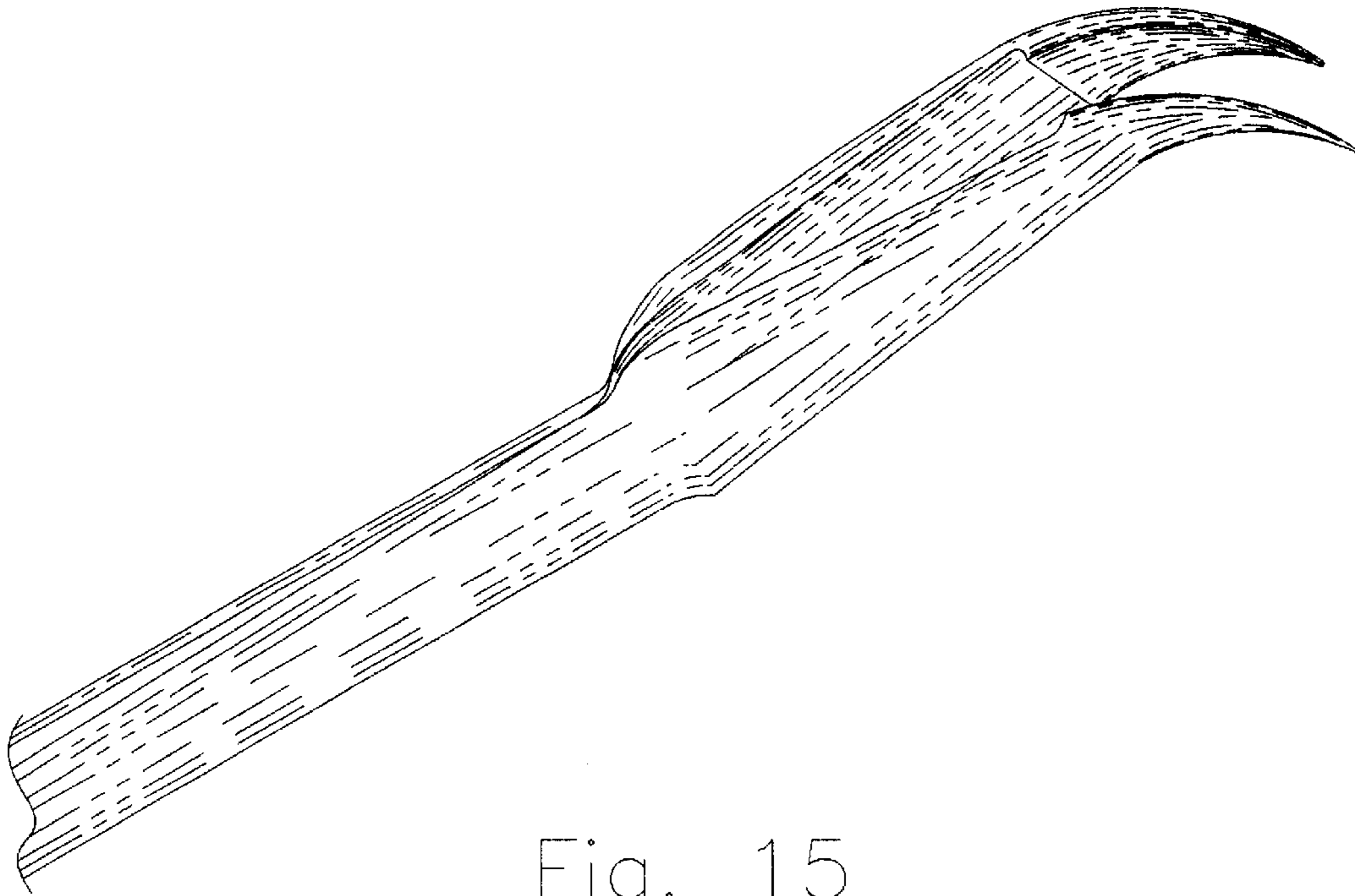

Fig. 15

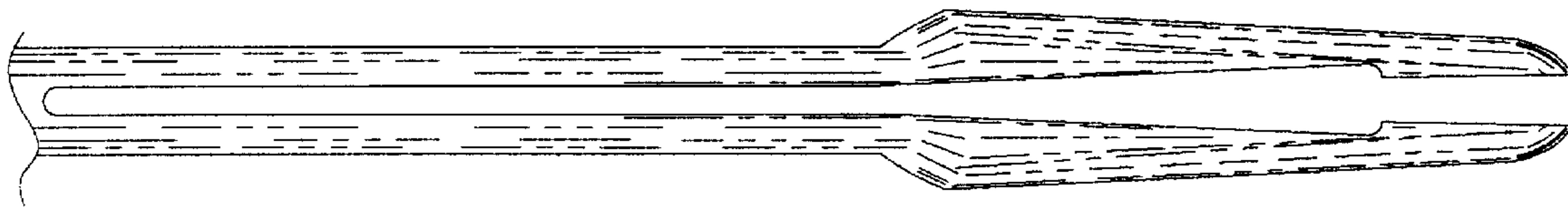

Fig. 16

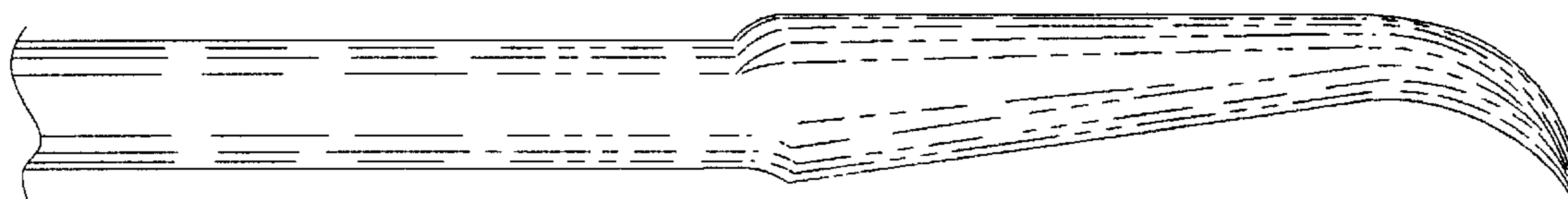

Fig. 17

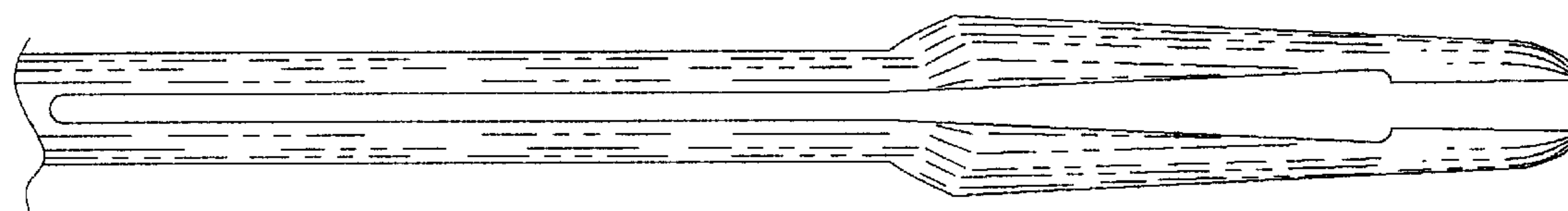

Fig. 18

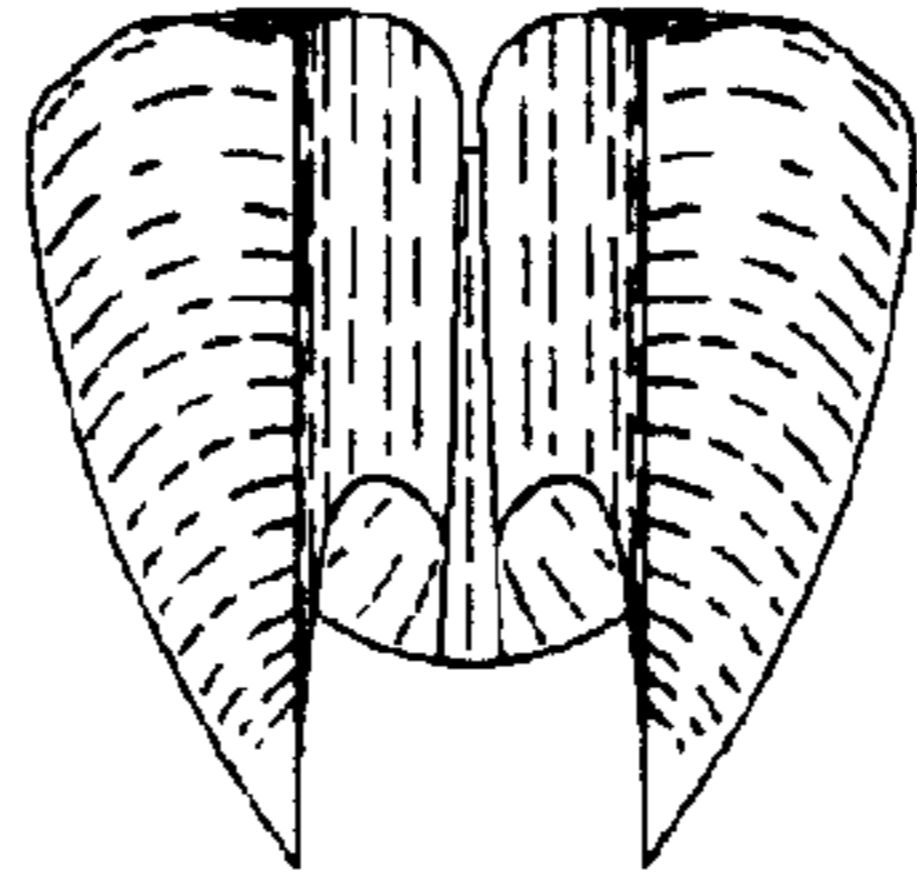

Fig. 19

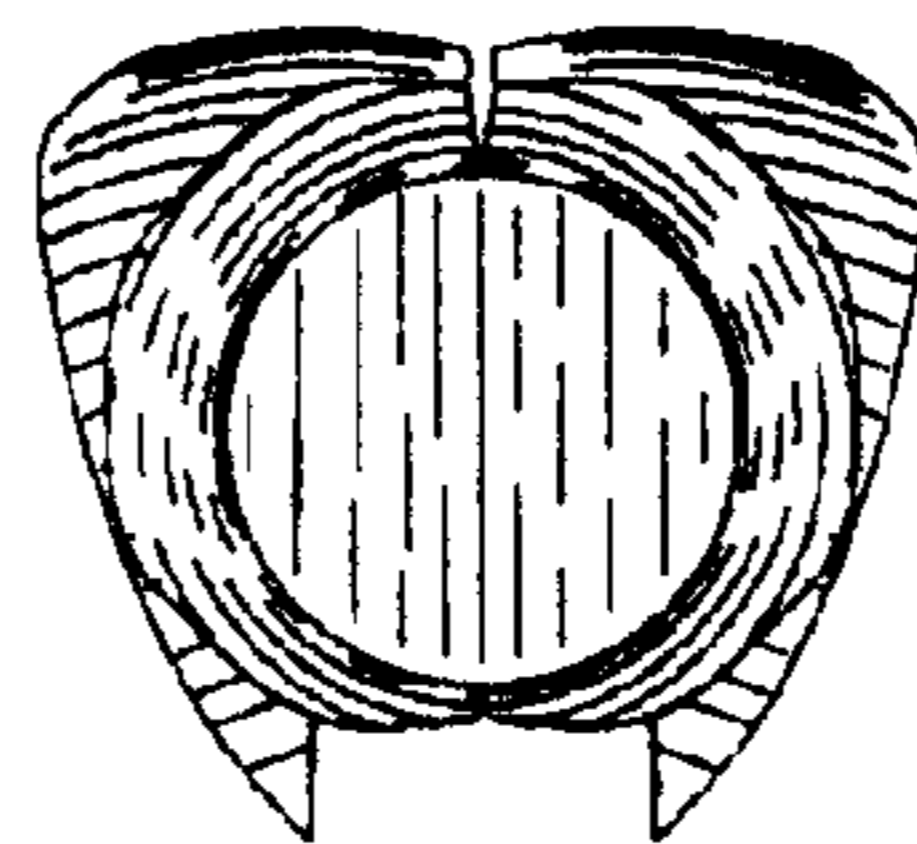

Fig. 20