



US00D530405S

(12) **United States Design Patent**
Douglass et al.

(10) **Patent No.:** **US D530,405 S**

(45) **Date of Patent:** **** Oct. 17, 2006**

(54) **SINK**

(75) Inventors: **John Michael Douglass**, Algonquin, IL (US); **Deborah Marie Plikuhn**, Lombard, IL (US)

(73) Assignee: **Elkay Manufacturing Company**, Oak Brook, IL (US)

(**) Term: **14 Years**

(21) Appl. No.: **29/229,180**

(22) Filed: **May 4, 2005**

(51) **LOC (8) Cl.** **23-02**

(52) **U.S. Cl.** **D23/285**

(58) **Field of Classification Search** D23/272-274, D23/284-285, 288-289, 291, 293.1, 303, D23/308; 4/515-516, 519, 619, 650, 661
See application file for complete search history.

(56) **References Cited**
PUBLICATIONS

Elkay press release: "Scrub-a-Dubs™ sinks from Elkay add Whimsy to Children's Bath", Football Sink, www.elkayusa.com, Apr. 1, 2006.*

* cited by examiner

Primary Examiner—Robert A. Delehanty

(74) *Attorney, Agent, or Firm*—Leydig, Voit & Mayer, Ltd.

(57) **CLAIM**

The ornamental design for a sink, as shown and described.

DESCRIPTION

FIG. 1 is a perspective view taken from the top, front and right side of a sink showing our new design;

FIG. 2 is a top plan view of the sink shown in FIG. 1;

FIG. 3 is a bottom view of the sink shown in FIG. 1;

FIG. 4 is a front side view of the sink shown in FIG. 1;

FIG. 5 is a rear side view of the sink shown in FIG. 1;

FIG. 6 is a left side view of the sink shown in FIG. 1; and,

FIG. 7 is a right side view of the sink shown in FIG. 1.

1 Claim, 5 Drawing Sheets

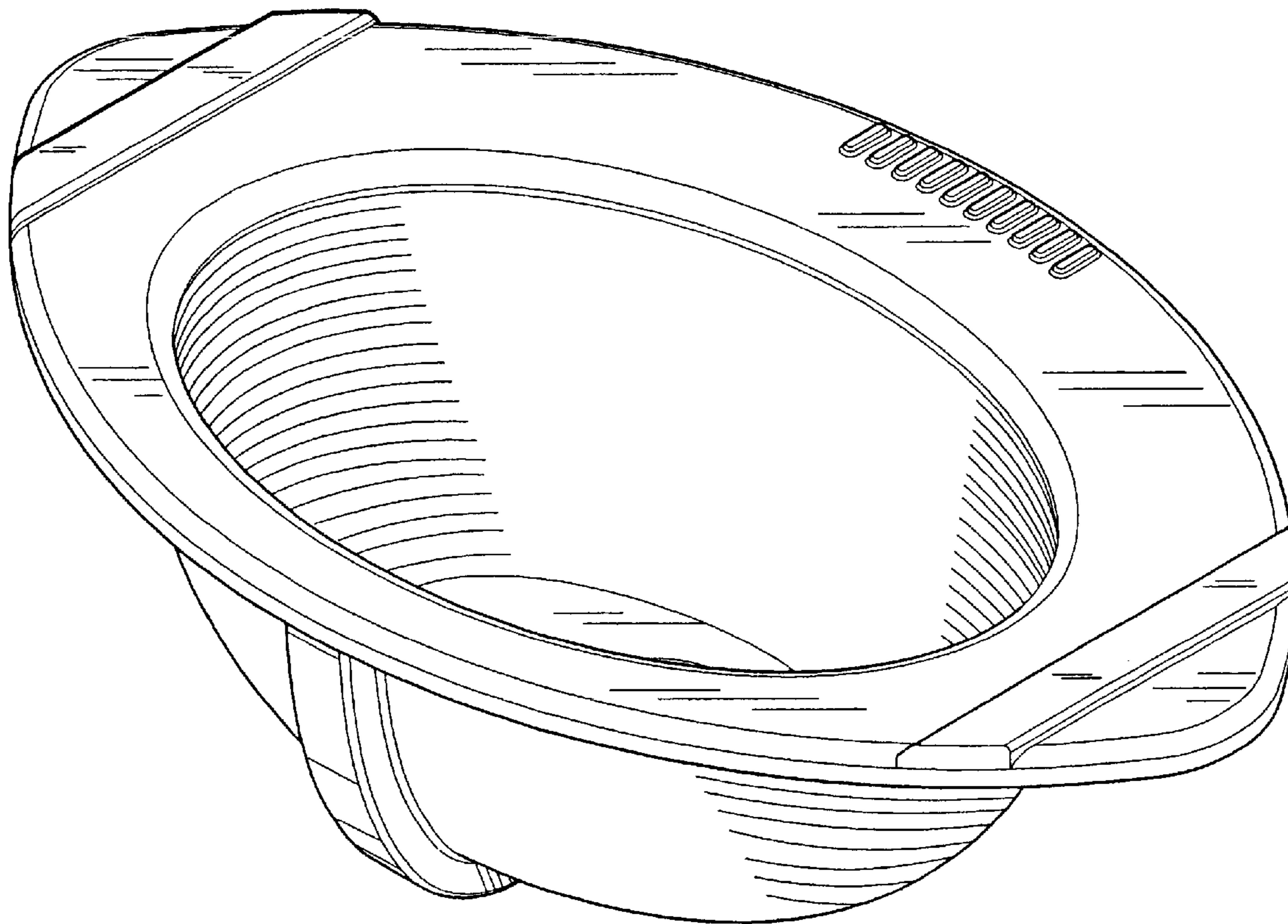

FIG. 1

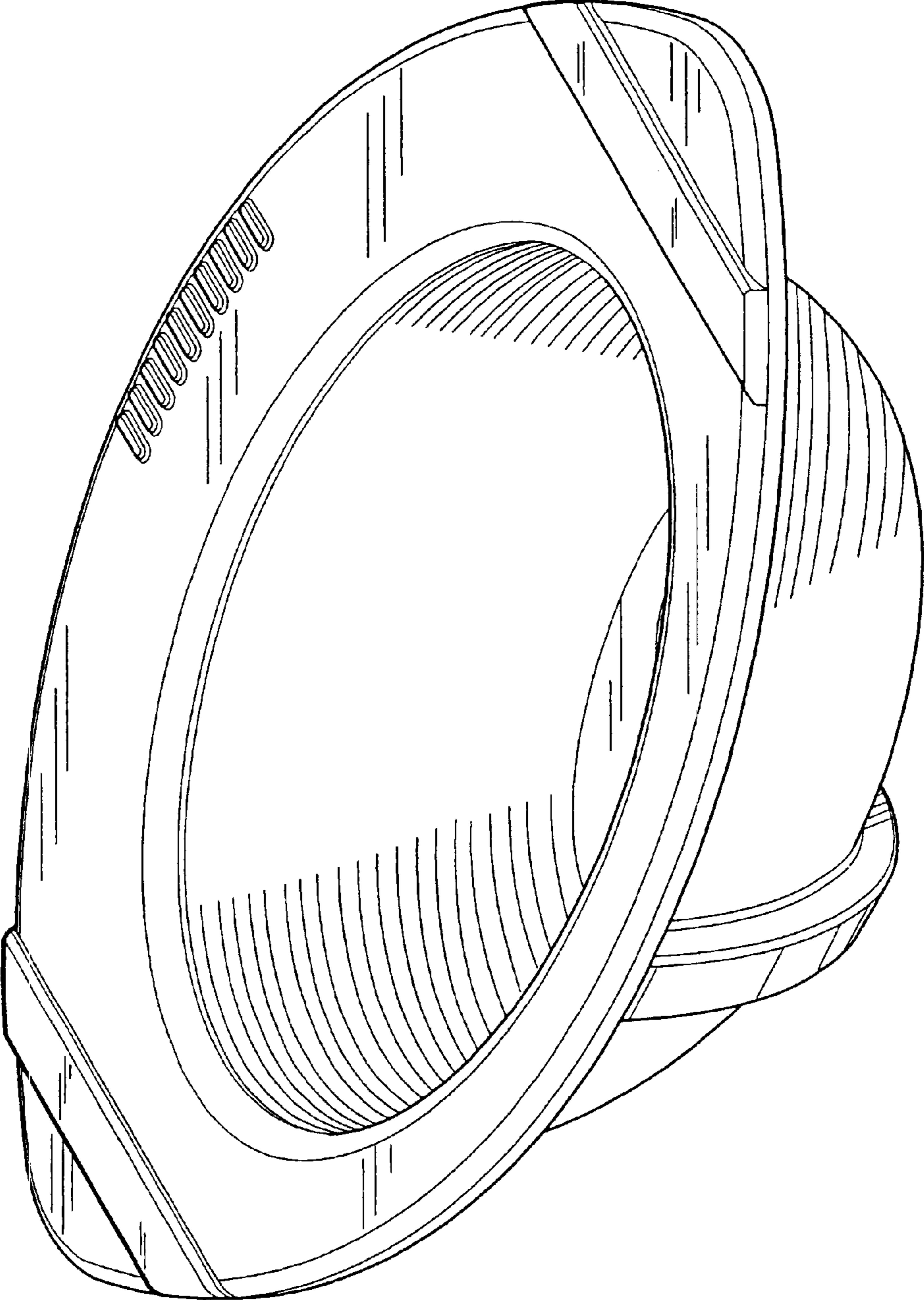

FIG. 2

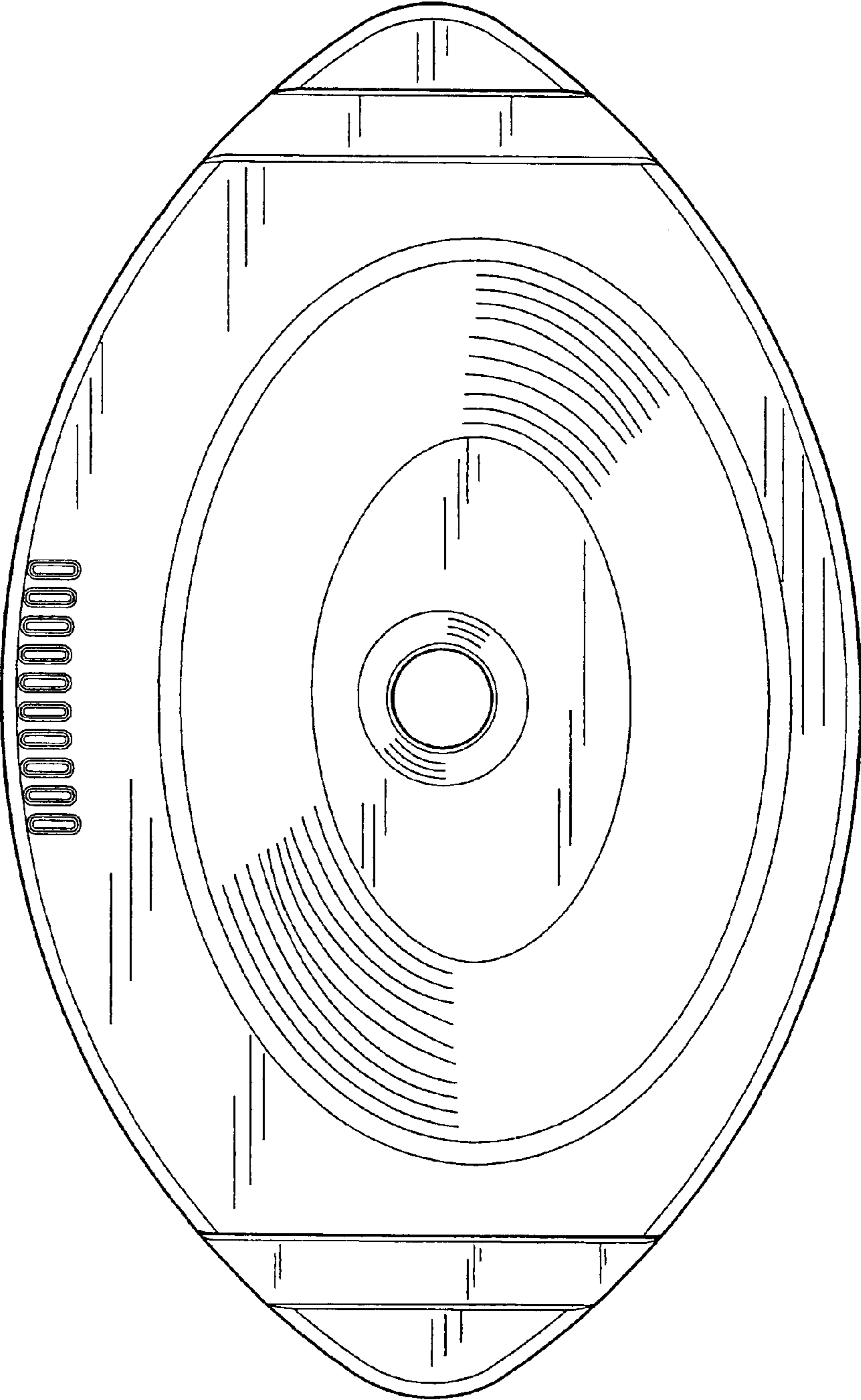

FIG. 3

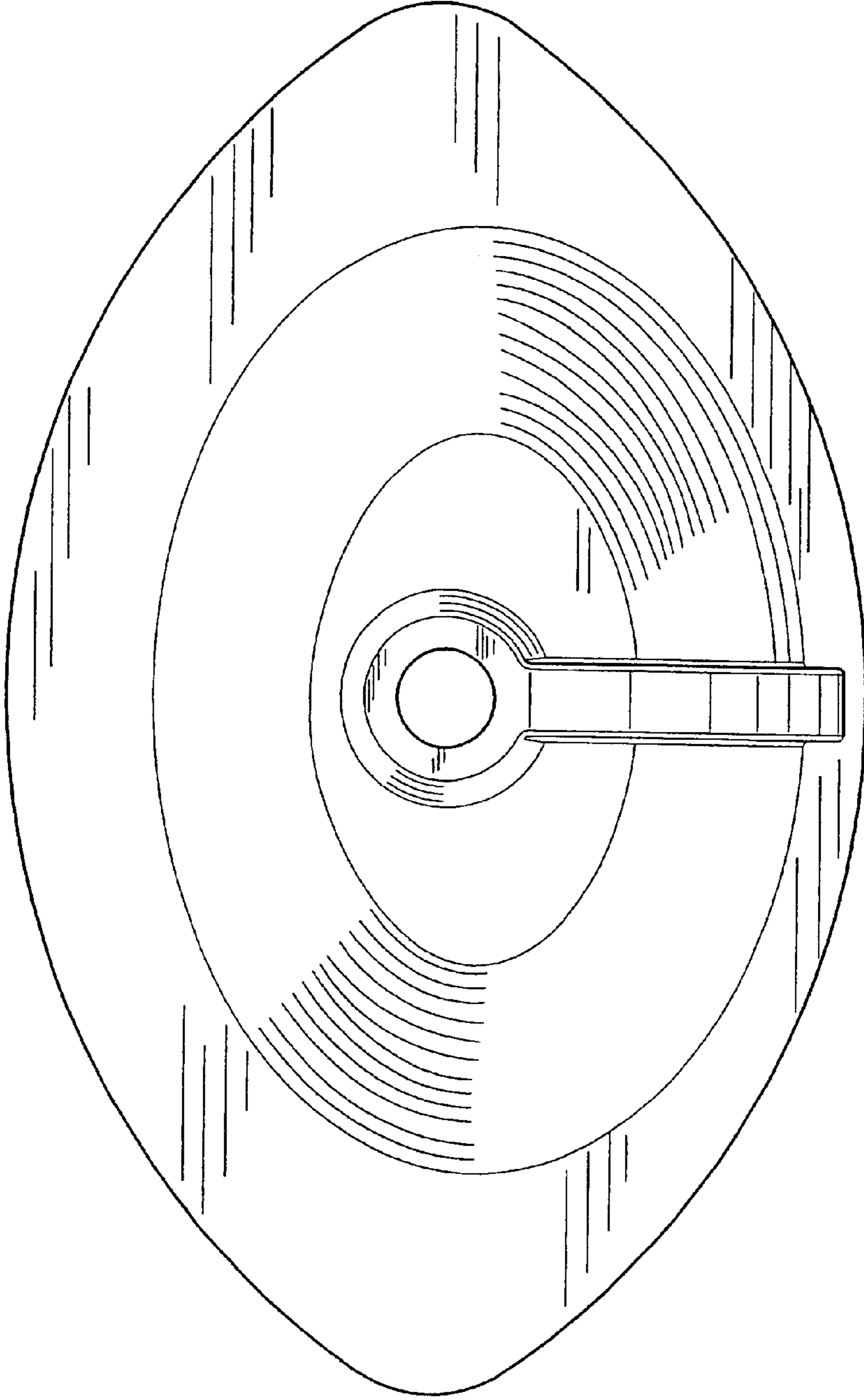

FIG. 4

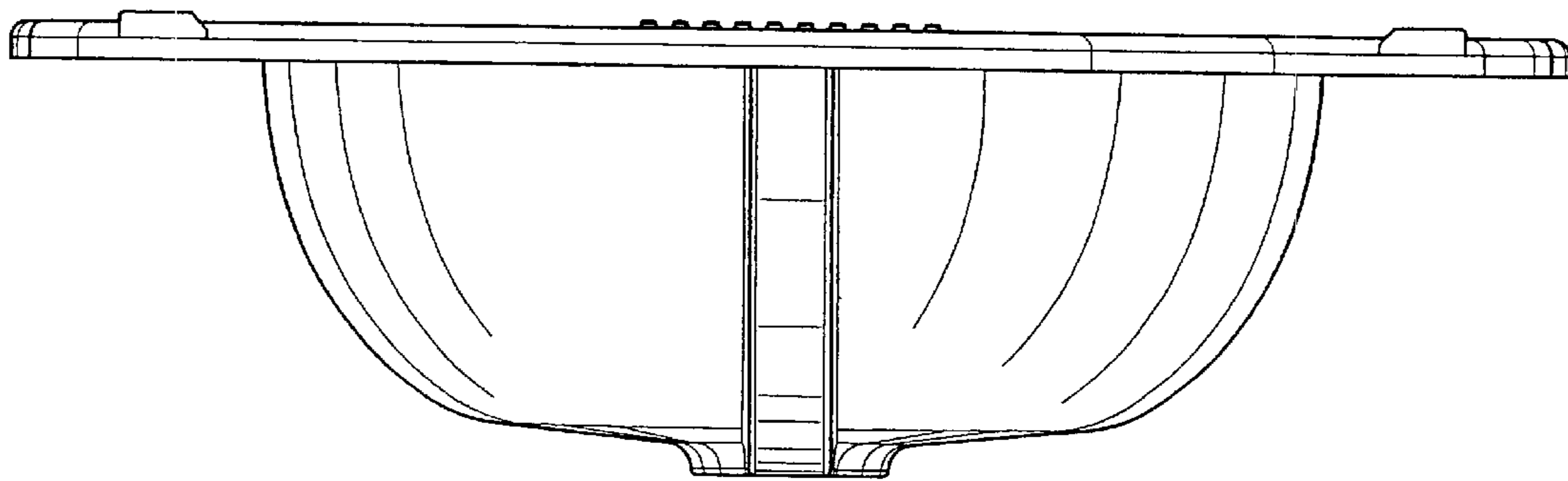

FIG. 5

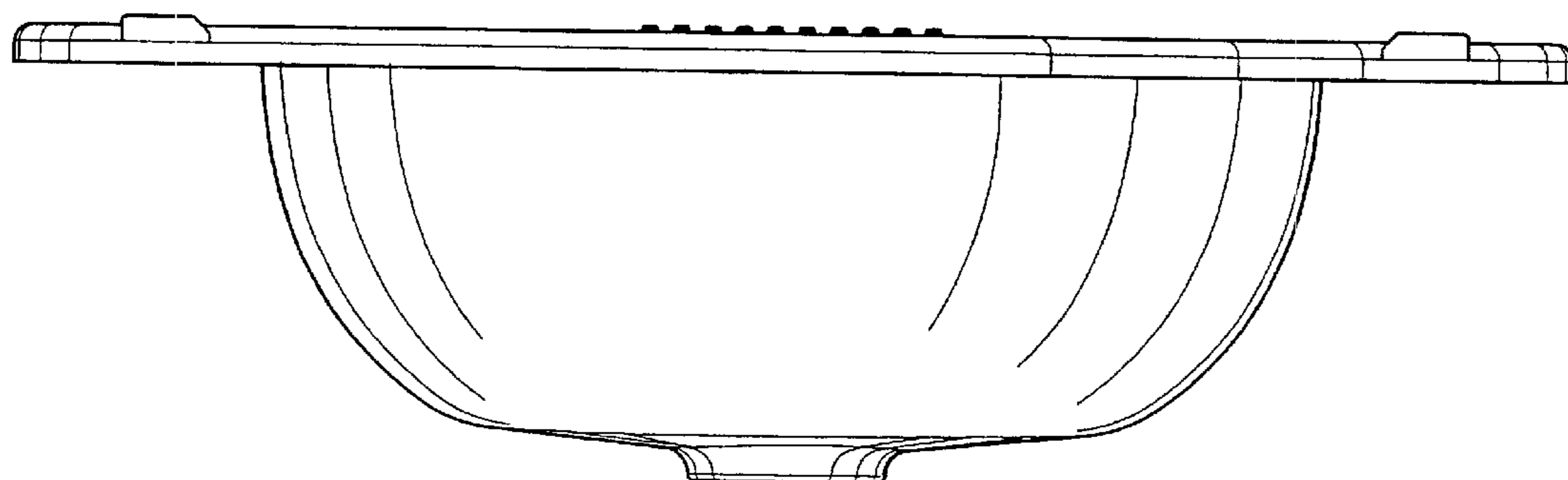

FIG. 6

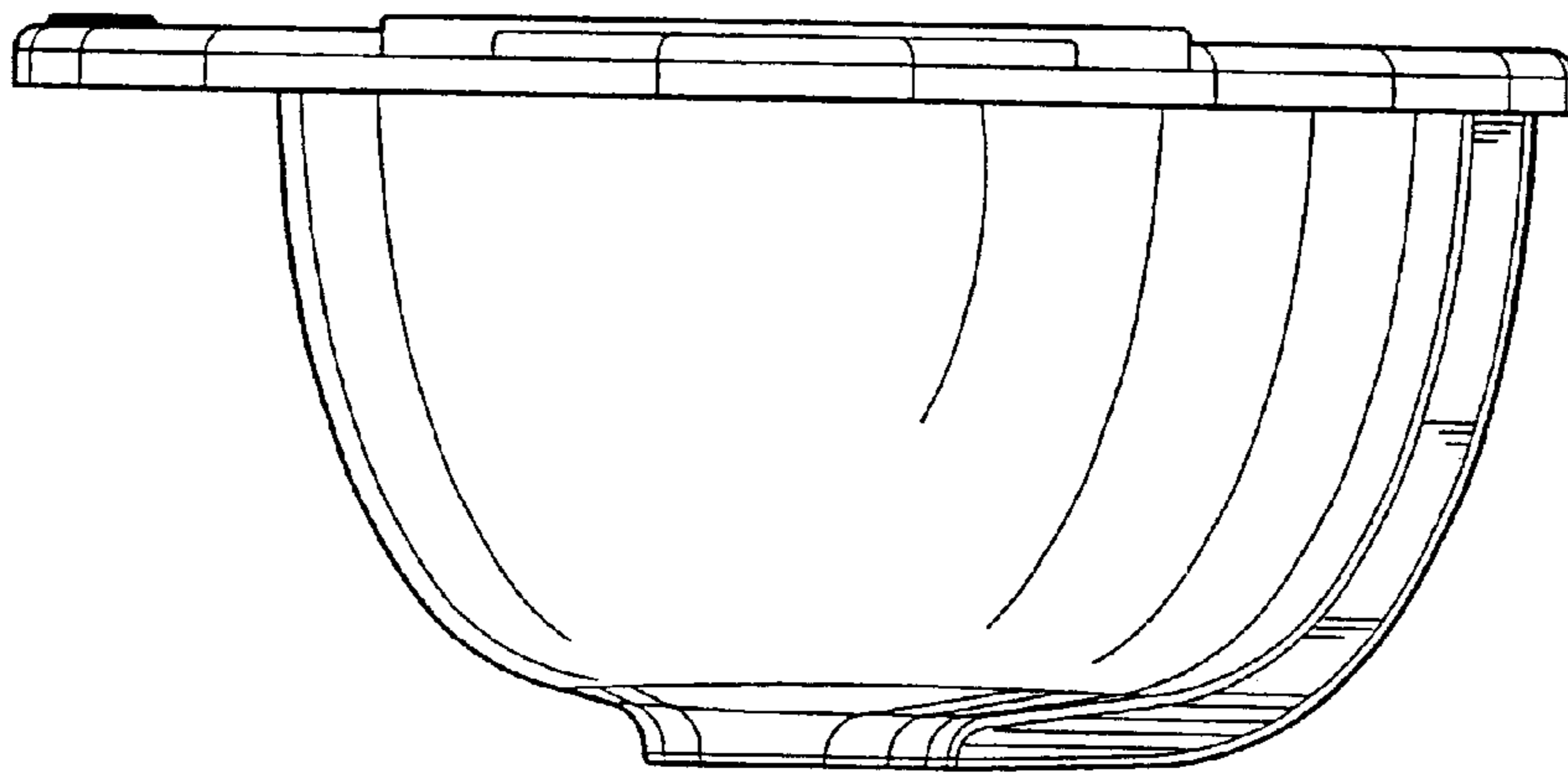

FIG. 7

