



US00D530378S

(12) **United States Design Patent**
Bird

(10) **Patent No.:** **US D530,378 S**

(45) **Date of Patent:** **** Oct. 17, 2006**

(54) **GAME CARD**

(75) Inventor: **Susan Willett Bird**, Greenwich, CT
(US)

(73) Assignee: **WF360**, New York, NY (US)

(**) Term: **14 Years**

(21) Appl. No.: **29/209,484**

(22) Filed: **Jul. 16, 2004**

(51) **LOC (8) Cl.** **21-01**

(52) **U.S. Cl.** **D21/376**

(58) **Field of Classification Search** D7/709;
D9/504; D19/59; D21/334-368, 385-386,
D21/396; 273/236-291, 292-294, 299, 300,
273/148 R; 434/166, 167

See application file for complete search history.

(56) **References Cited**

U.S. PATENT DOCUMENTS

D109,938	S	*	5/1938	Lightfoot et al.	D7/709
D322,753	S	*	12/1991	Sussman	D9/504
5,316,482	A	*	5/1994	Bryson	273/236
5,435,726	A	*	7/1995	Taylor	273/263
5,478,085	A	*	12/1995	Canner et al.	273/239
5,941,526	A	*	8/1999	Martens et al.	273/249
D429,608	S	*	8/2000	Hoffman	D7/709
6,139,326	A	*	10/2000	Catto	434/167
6,168,439	B1	*	1/2001	Anderson	434/167
2001/0039000	A1	*	11/2001	Parsons	434/166

2002/0061508 A1 * 5/2002 Vicia 434/409
2003/0001336 A1 1/2003 Parker

* cited by examiner

Primary Examiner—Sandra L. Morris

(57) **CLAIM**

The ornamental design for a game card, as shown and described.

DESCRIPTION

FIG. 1 illustrates a perspective view of a game card, showing my new design;

FIG. 2 illustrates a top elevational view thereof;

FIG. 3 illustrates a front plan view thereof;

FIG. 4 illustrates a bottom elevational view thereof;

FIG. 5 illustrates a right side elevational view thereof;

FIG. 6 illustrates a rear plan view thereof in one embodiment;

FIG. 7 illustrates a rear plan view thereof in another embodiment;

FIG. 8 illustrates a perspective view of a container and plurality of cards, showing my new design;

FIG. 9 illustrates another perspective view of a container and plurality of cards, showing my new design; and,

FIG. 10 illustrates a perspective view of another container and game card, showing my new design.

The broken lines in the figures have been shown for illustration purposes only and form no part of the claimed invention.

1 Claim, 3 Drawing Sheets

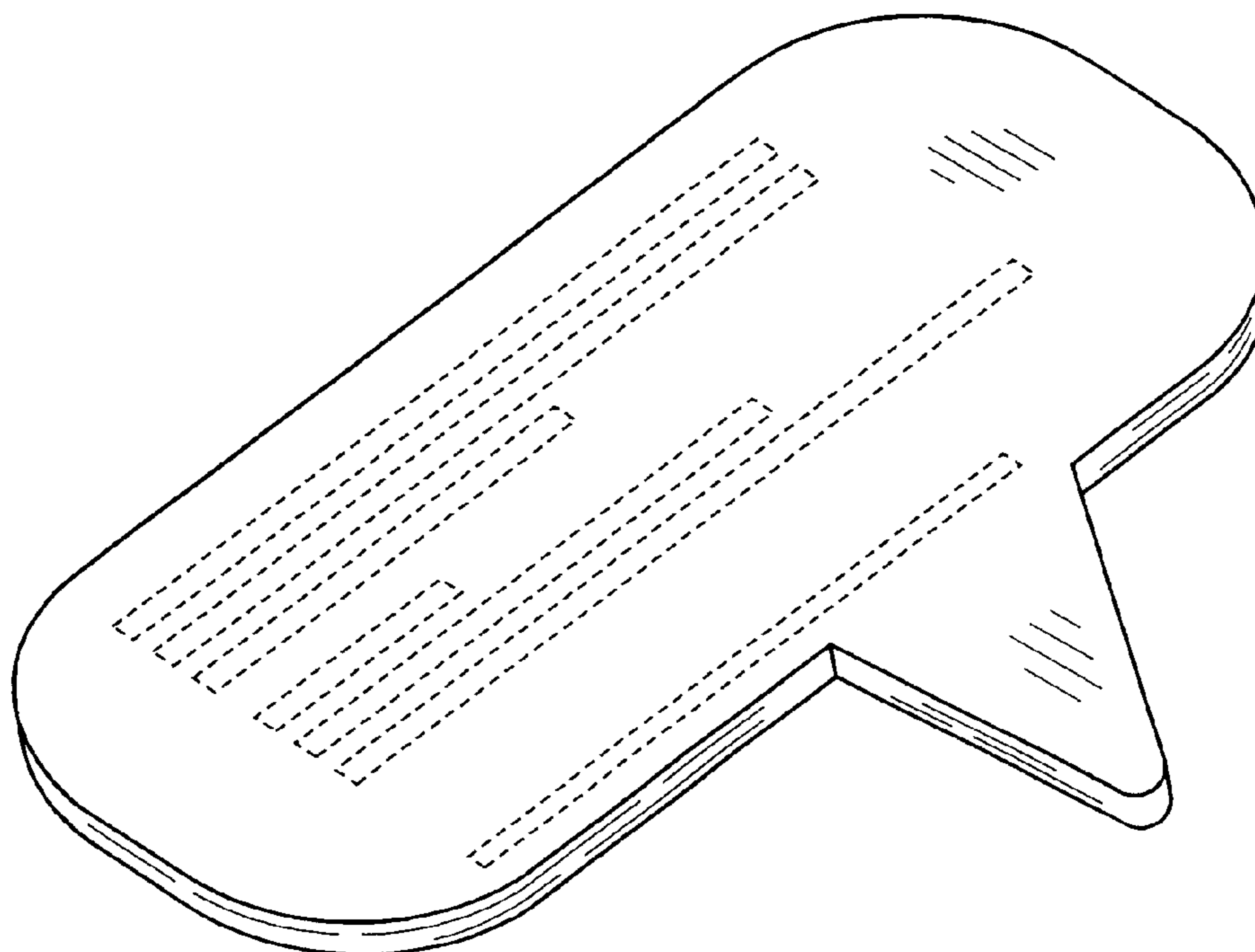

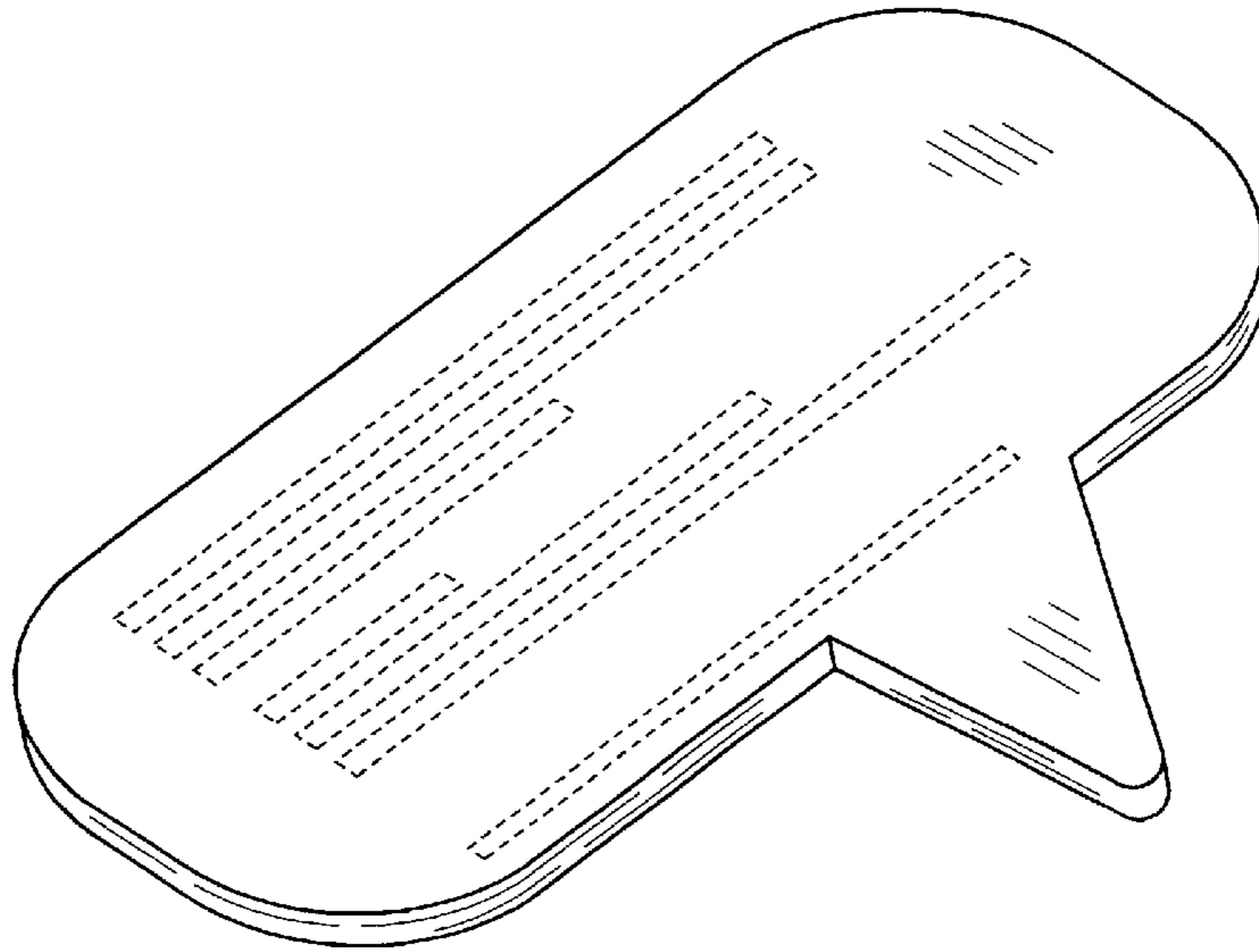

FIG. 1



FIG. 2

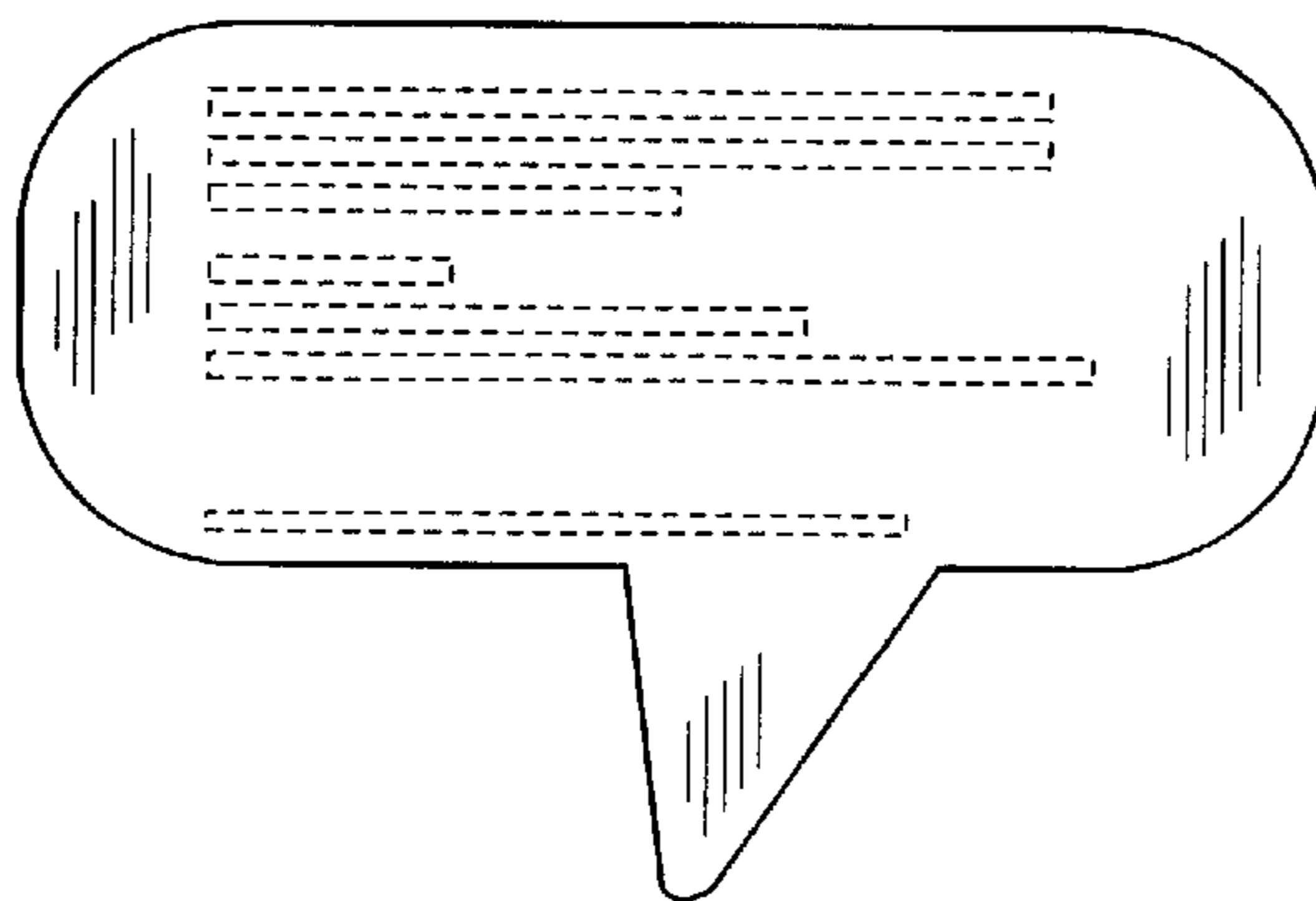

FIG. 3



FIG. 5



FIG. 4

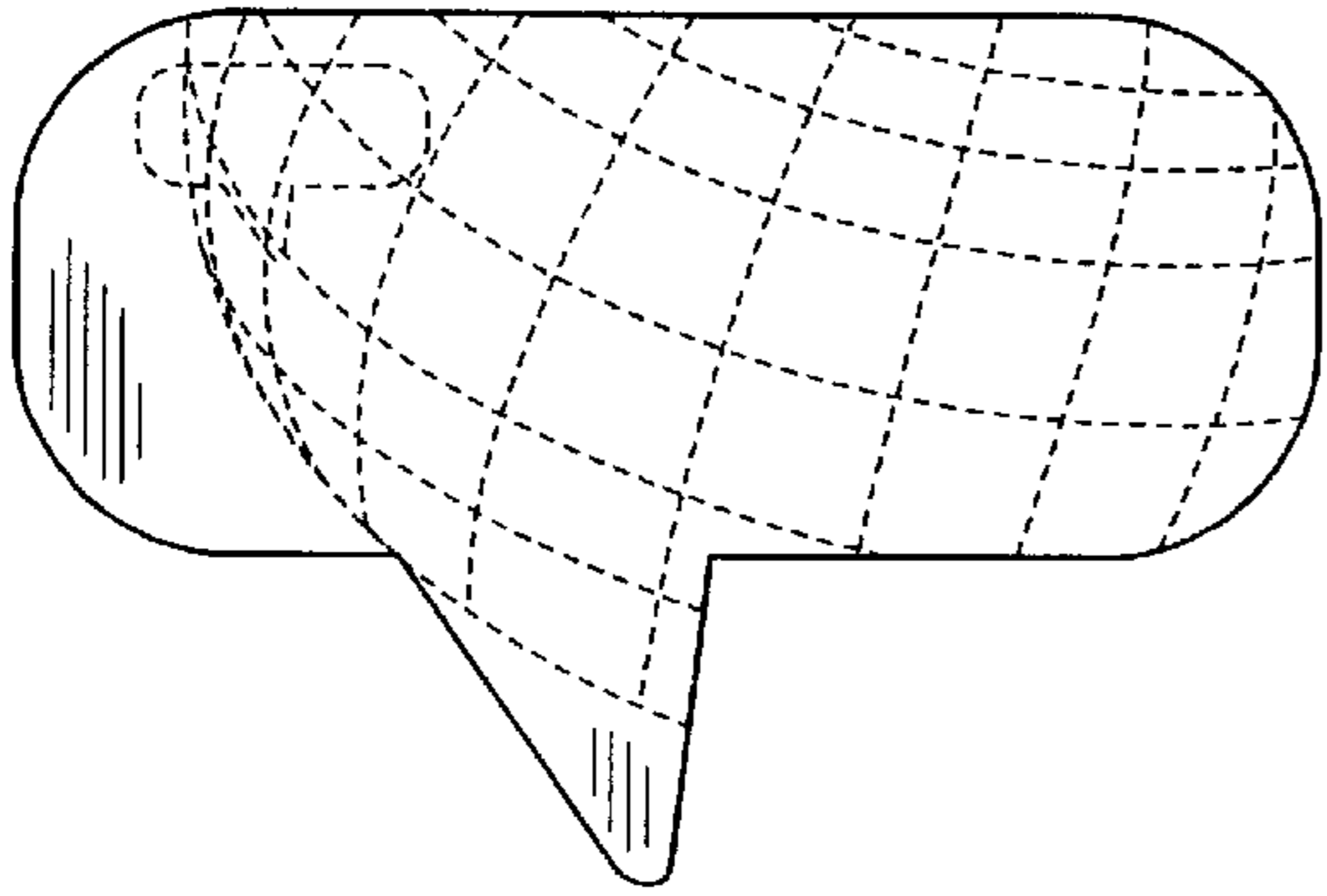

FIG. 6

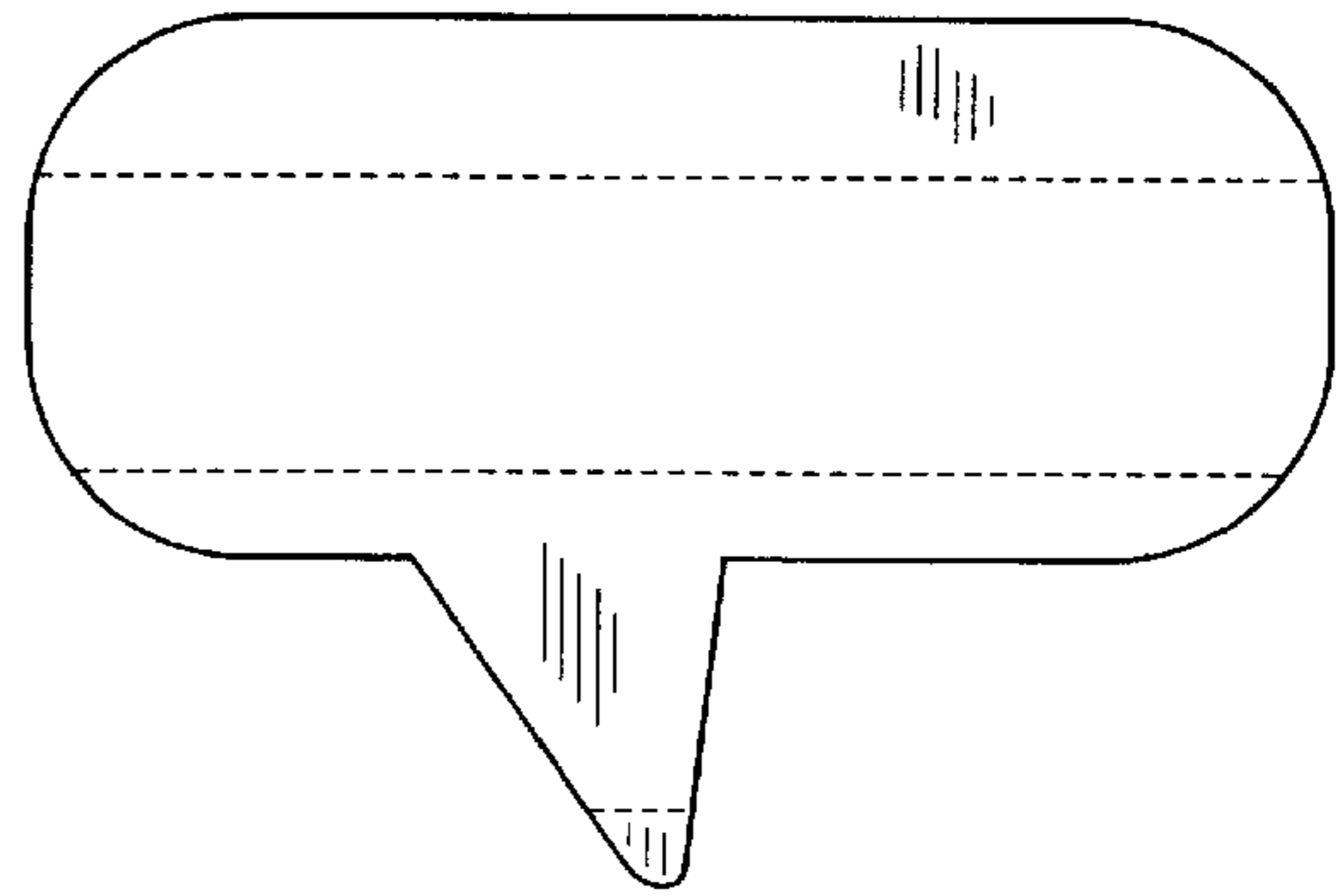

FIG. 7

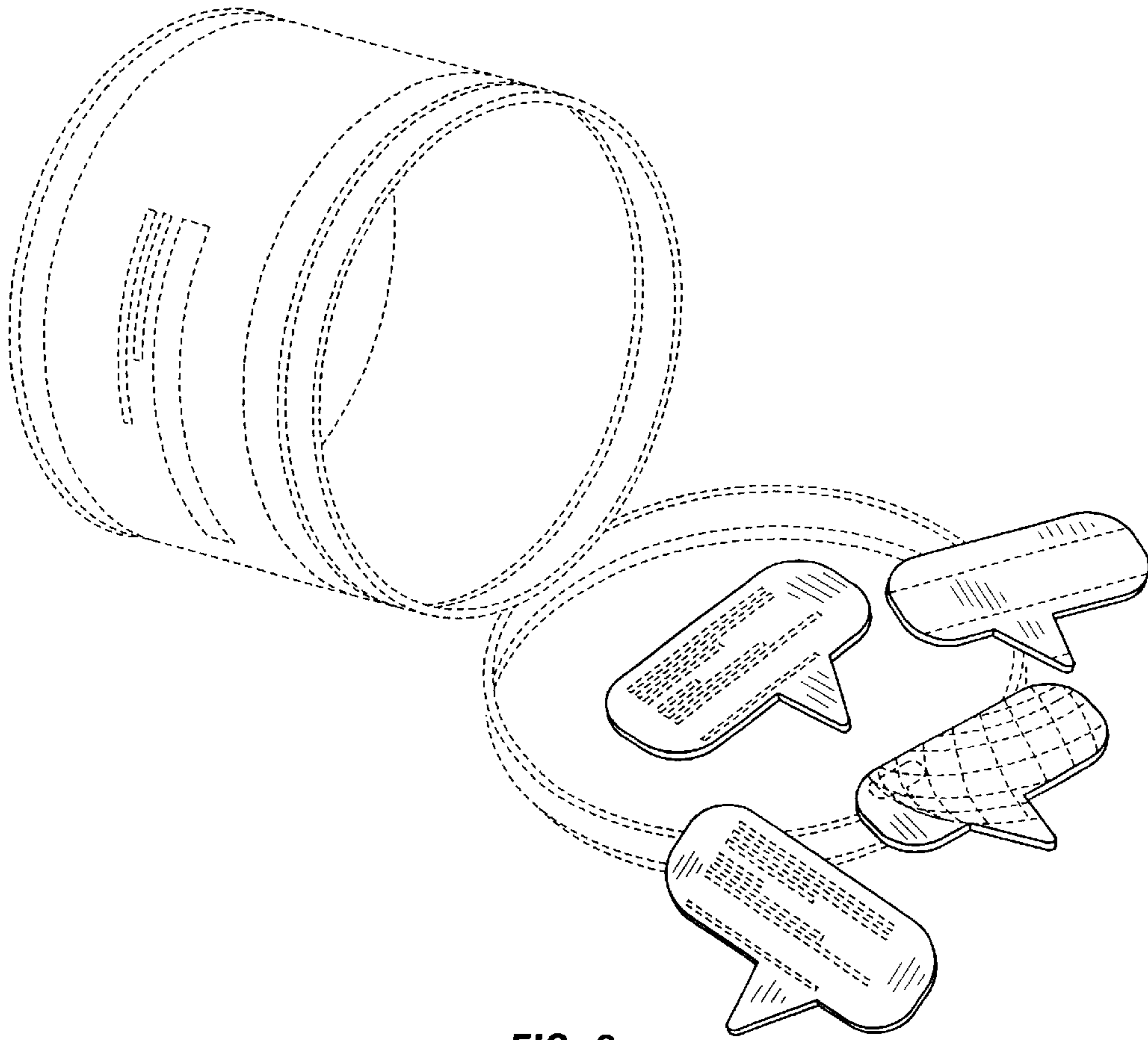

FIG. 8

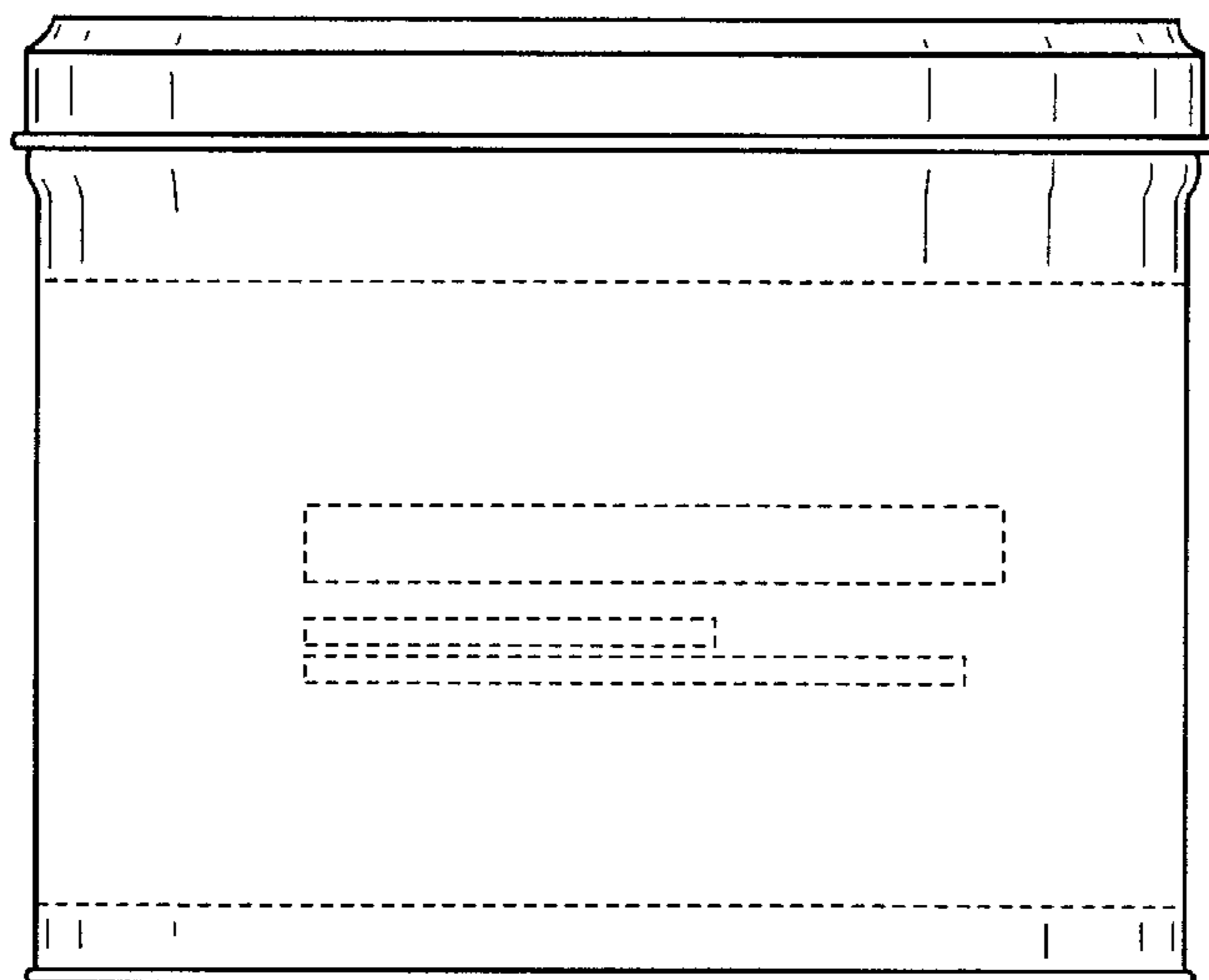

FIG. 9

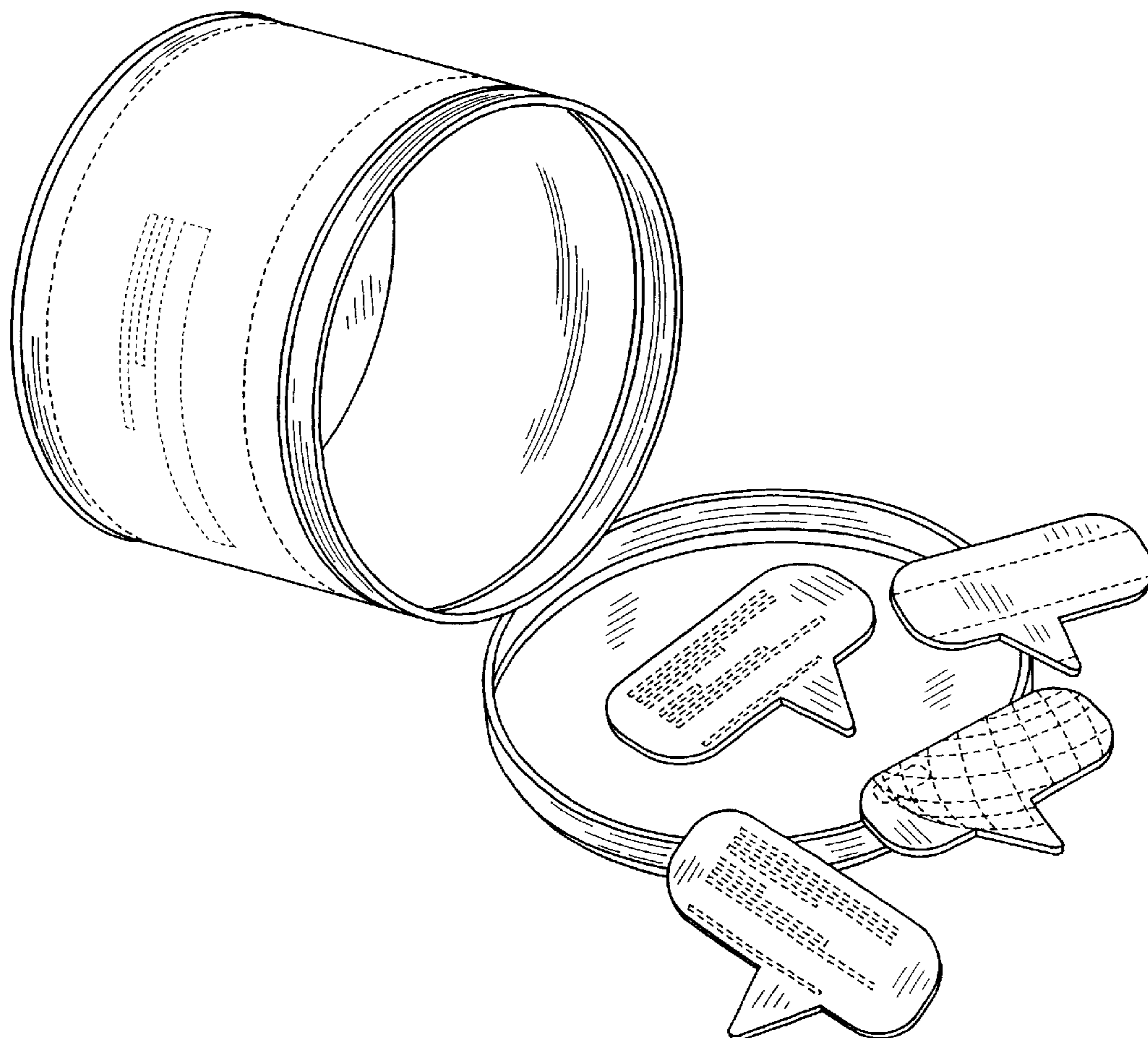

FIG. 10