



US00D530184S

(12) **United States Design Patent**  
**Oas**

(10) **Patent No.:** **US D530,184 S**

(45) **Date of Patent:** **\*\* Oct. 17, 2006**

(54) **CARABINEER PILL BOX**

(75) Inventor: **Daniel Oas**, Irwindale, CA (US)

(73) Assignee: **Calibre International, LLC**, Irwindale, CA (US)

(\*\*) Term: **14 Years**

(21) Appl. No.: **29/222,403**

(22) Filed: **Jan. 26, 2005**

(51) **LOC (8) Cl.** ..... **08-03**

(52) **U.S. Cl.** ..... **D8/333; D8/343; D9/414; D9/415**

(58) **Field of Classification Search** ..... **D8/330, D8/331, 343, 333, 335, 339, 373; D9/414, D9/415, 428; 70/14-17, 30, 51, 52, 58, 57.1, 70/63, 206, 233, 431, 465; 206/528-530, 206/828**

See application file for complete search history.

(56) **References Cited**

**U.S. PATENT DOCUMENTS**

D241,304	S	*	9/1976	Snader	.....	D8/333
4,333,562	A	*	6/1982	Todd	.....	206/37
4,765,459	A	*	8/1988	Edwards	.....	206/38.1
5,421,177	A	*	6/1995	Sieber et al.	.....	70/57.1
5,775,485	A	*	7/1998	Dierking	.....	206/38
D501,843	S	*	2/2005	Oas	.....	D14/188

D502,936	S	*	3/2005	Oas	.....	D14/188
D505,938	S	*	6/2005	Tse	.....	D14/196
6,933,847	B1	*	8/2005	Feibelman	.....	340/572.1
D516,541	S	*	3/2006	Bhavnani	.....	D14/192
7,032,590	B1	*	4/2006	Loeffler et al.	.....	128/200.24

\* cited by examiner

*Primary Examiner*—Prabhakar Deshmukh

(74) *Attorney, Agent, or Firm*—The Soni Law Firm

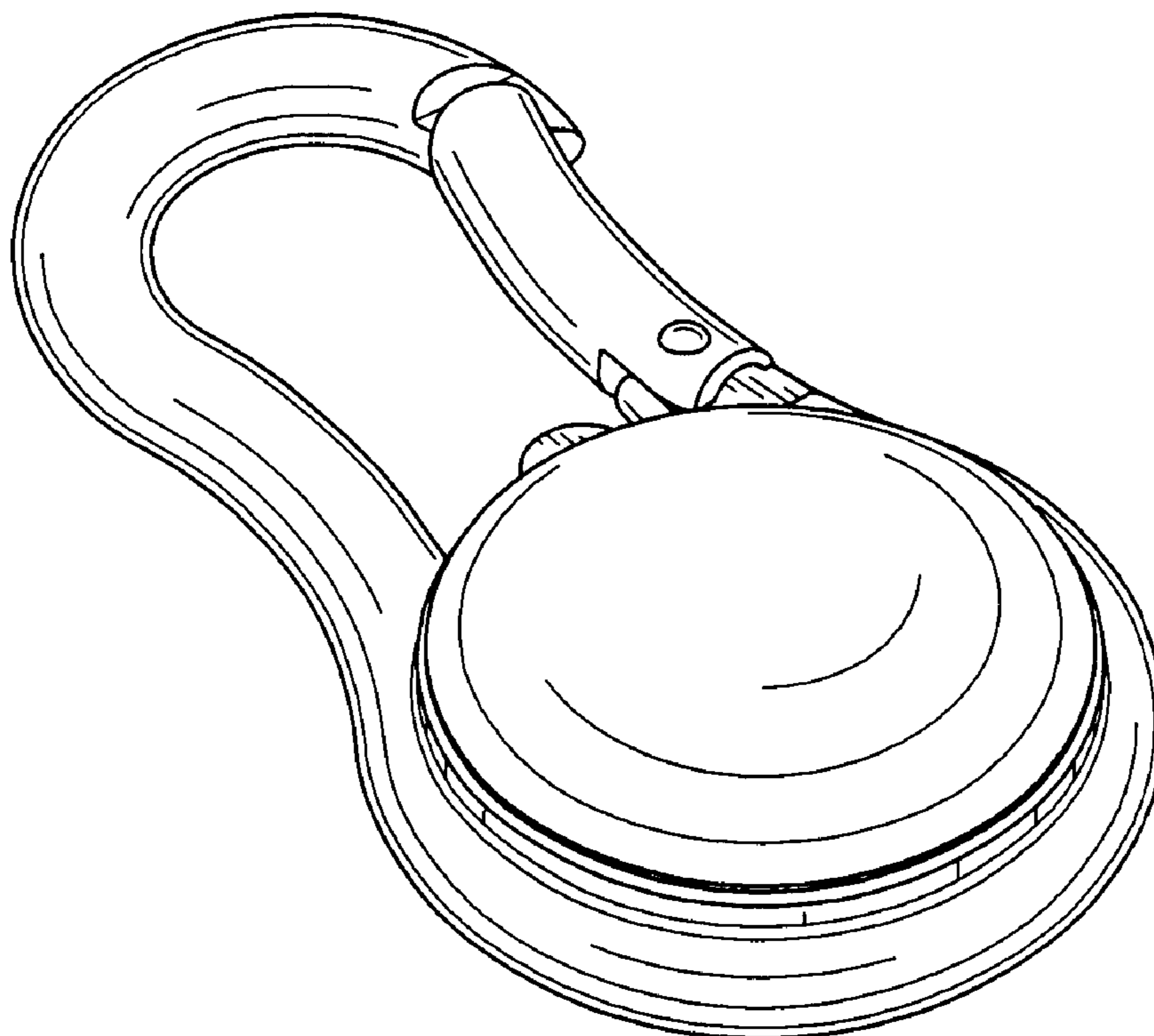
(57) **CLAIM**

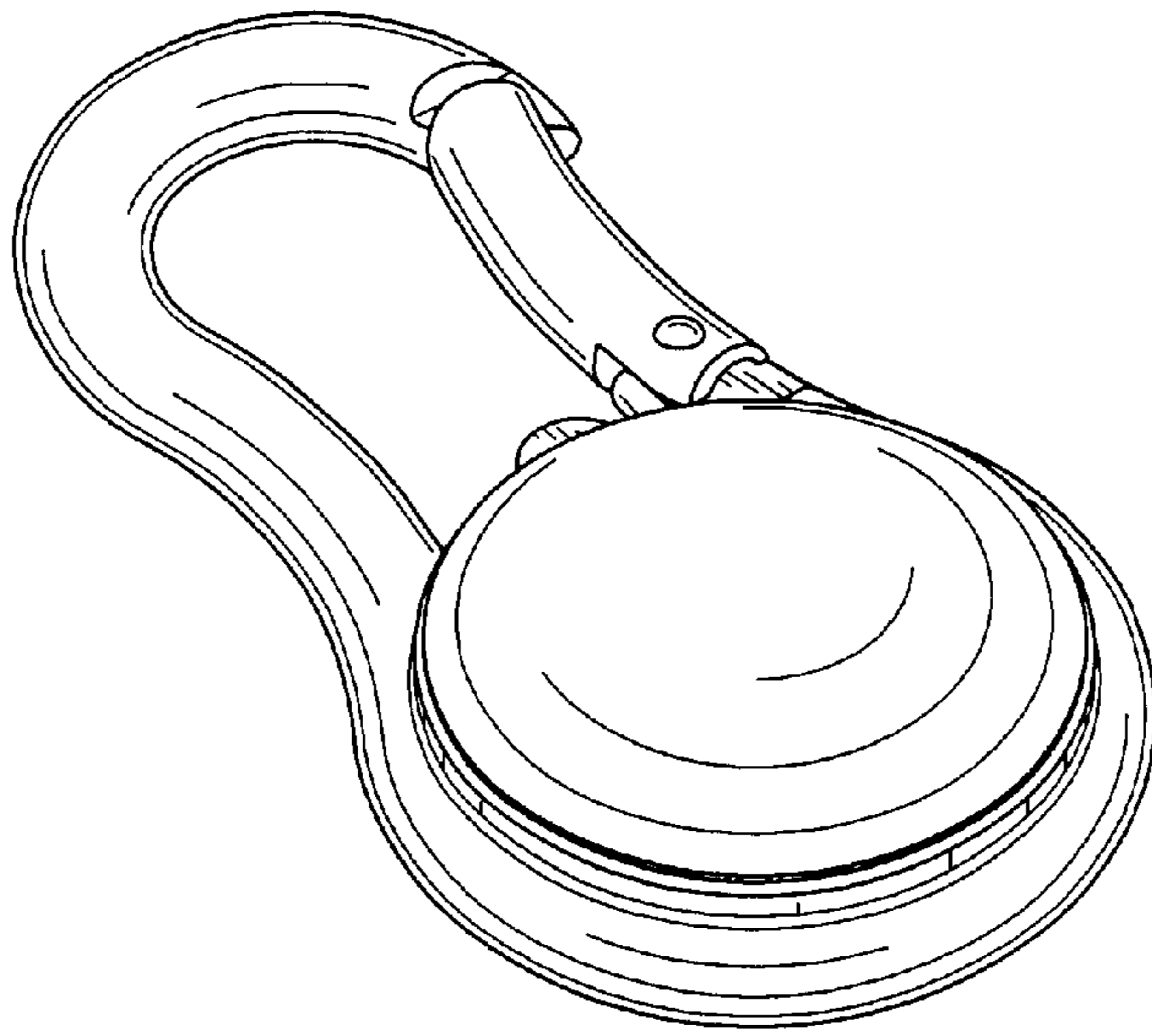
The ornamental design for a carabineer pill box, as shown and described.

**DESCRIPTION**

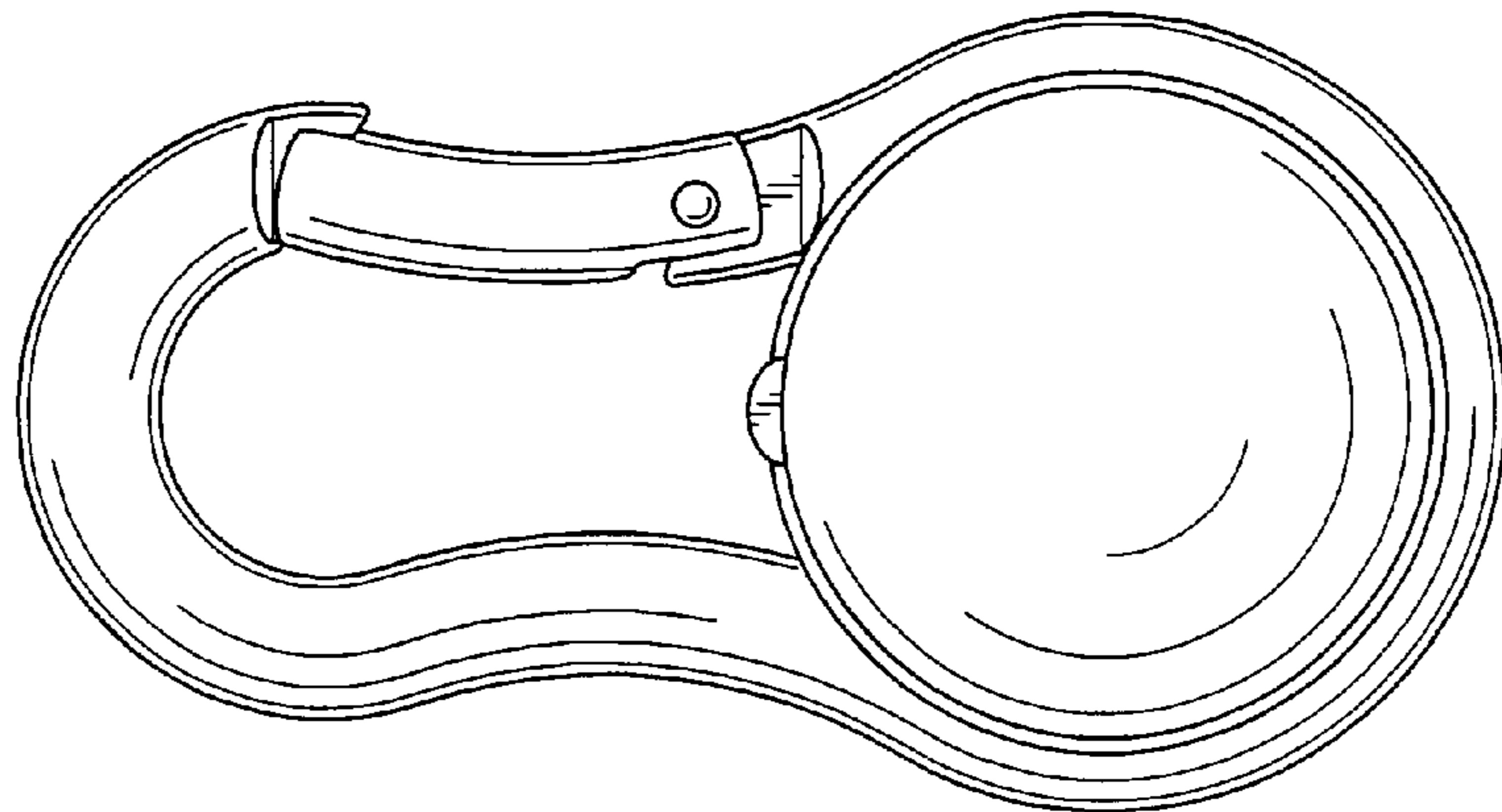
FIG. 1 is a top front perspective view of a carabineer pill box;  
 FIG. 2 is a front view of the carabineer pill box of FIG. 1;  
 FIG. 3 is a right side elevation view of the carabineer pill box of FIG. 1;  
 FIG. 4 is a left side elevation view of the carabineer pill box of FIG. 1;  
 FIG. 5 is a top plan view of the carabineer pill box of FIG. 1;  
 FIG. 6 is a bottom plan view of the carabineer pill box of FIG. 1;  
 FIG. 7 is a rear view of the carabineer pill box of FIG. 1; and,  
 FIG. 8 is an exploded top front perspective of the carabineer pill box of FIG. 1.

**1 Claim, 3 Drawing Sheets**

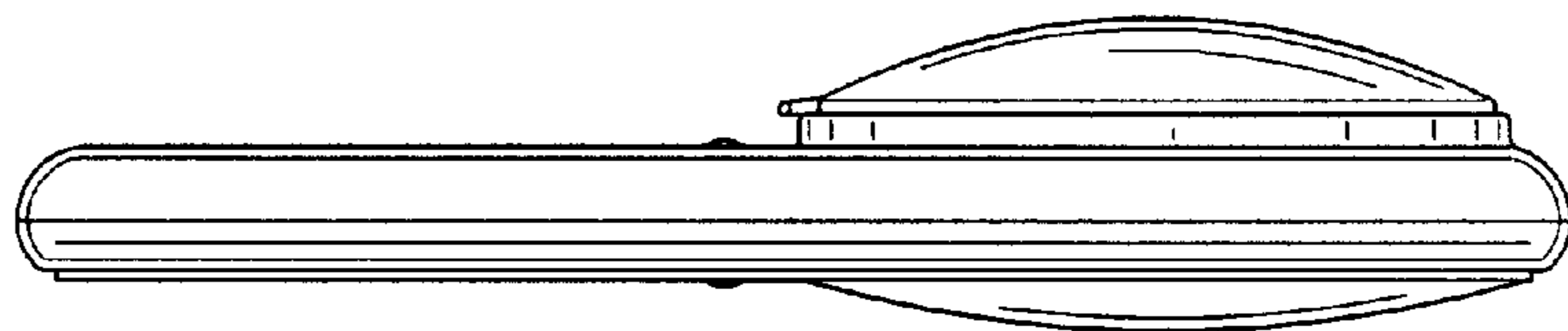




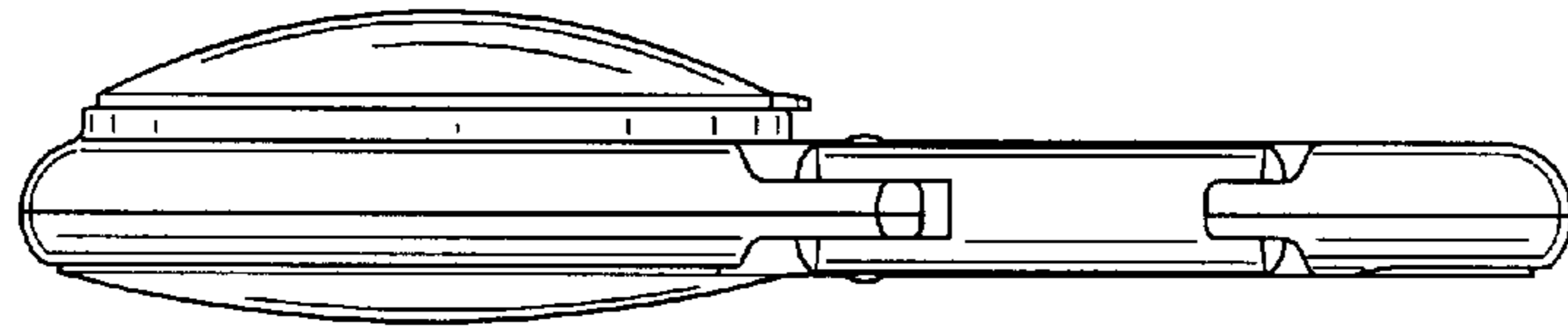
*FIG. 1*



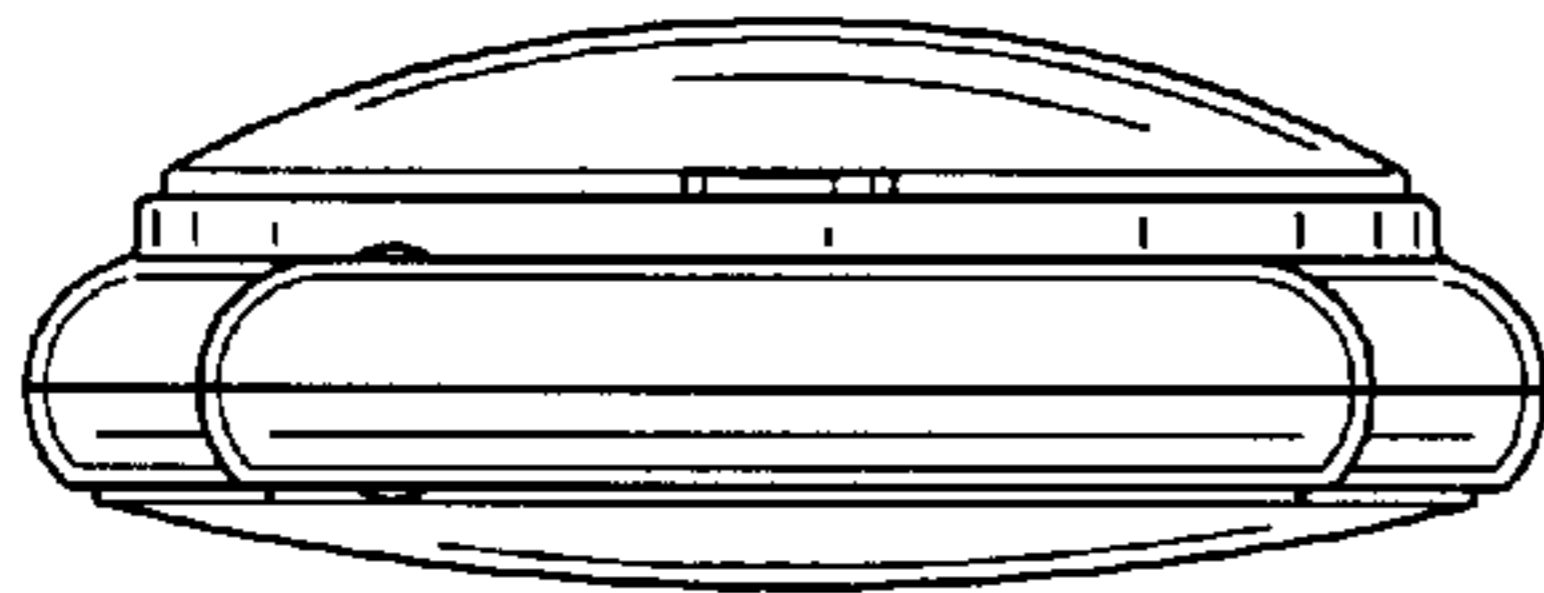
*FIG. 2*



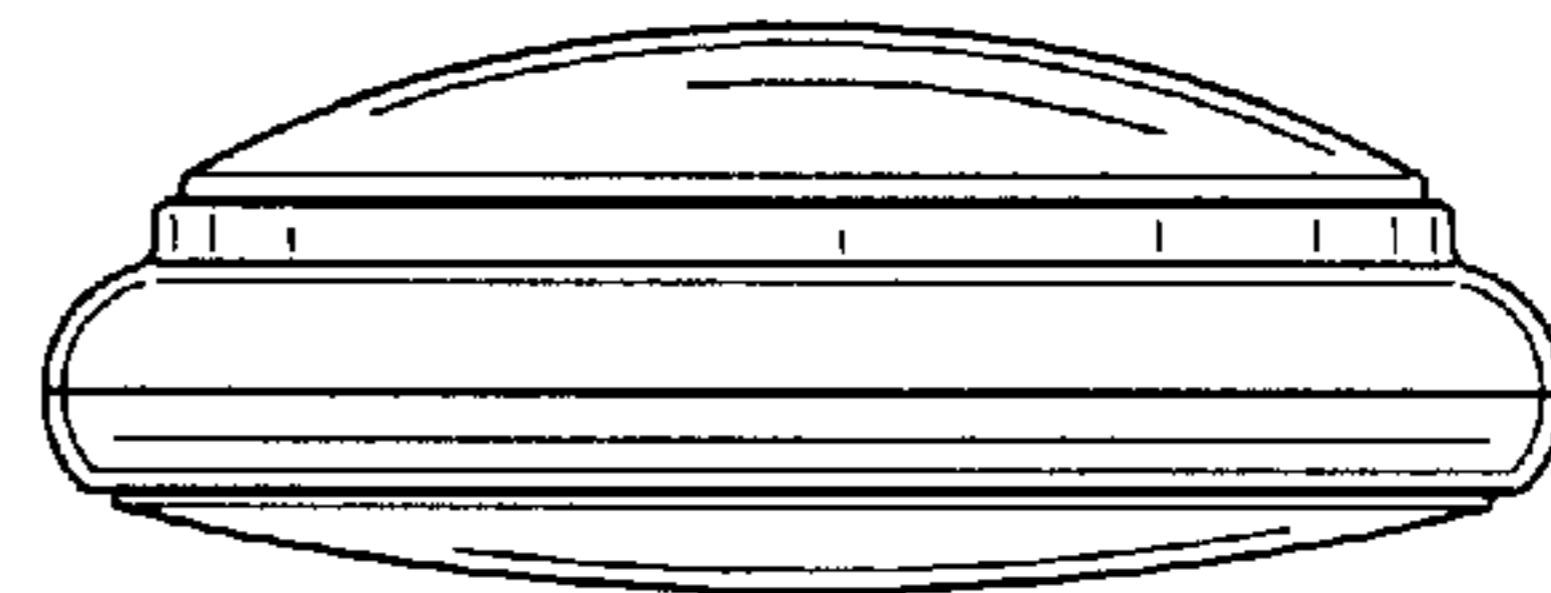
*FIG. 3*



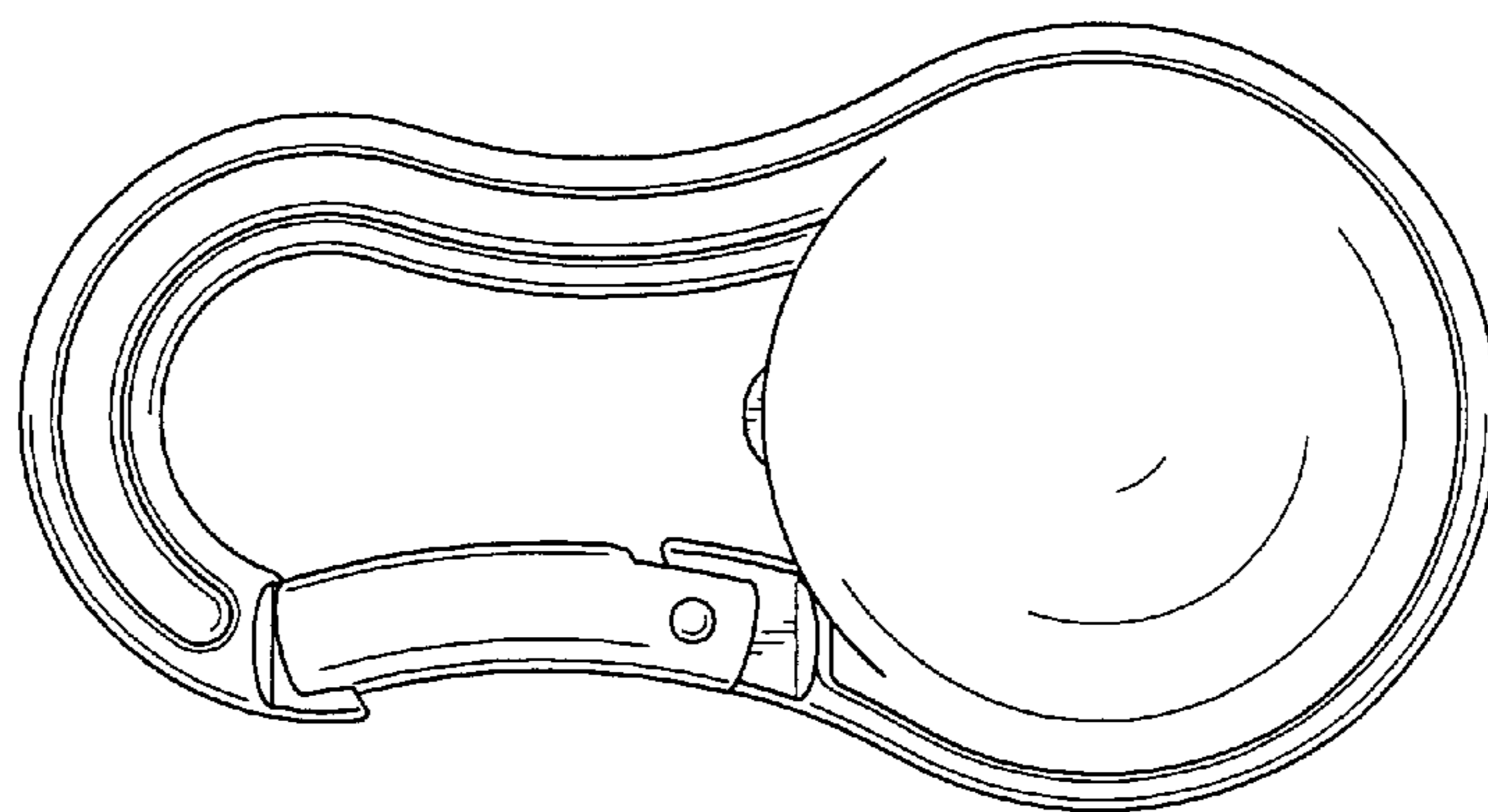
*FIG. 4*



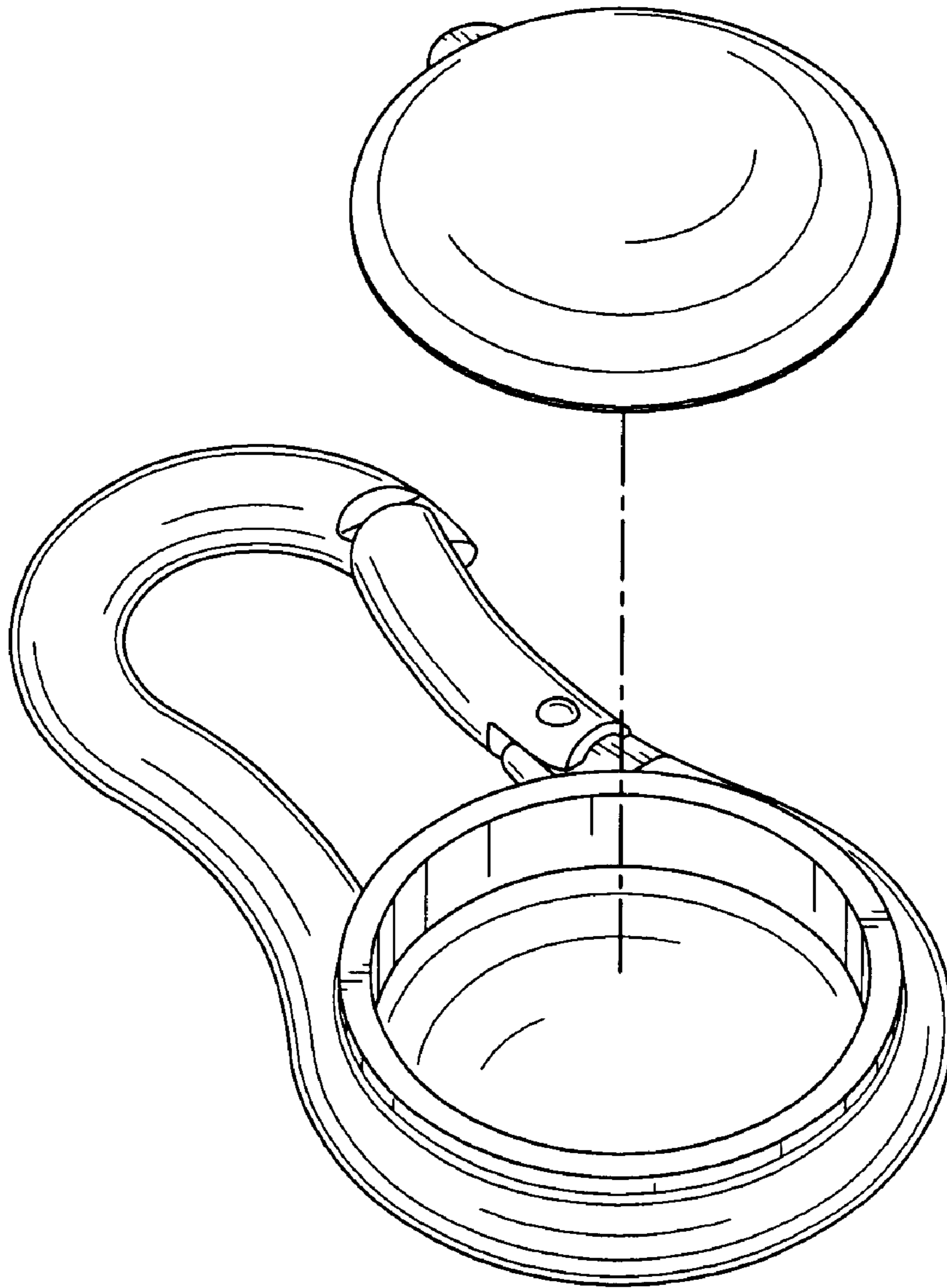
*FIG. 5*



*FIG. 6*



*FIG. 7*



*FIG. 8*