



US00D530141S

(12) **United States Design Patent** (10) **Patent No.:** **US D530,141 S**
Wilgus et al. (45) **Date of Patent:** **** Oct. 17, 2006**

(54) **BEVERAGE COOLER**

(75) Inventors: **Mitchell L. Wilgus**, Andover, KS (US);
Timothy M. Holub, Cheney, KS (US)

(73) Assignee: **The Coleman Company, Inc.**, Wichita,
KS (US)

(**) Term: **14 Years**

(21) Appl. No.: **29/238,749**

(22) Filed: **Sep. 20, 2005**

(51) **LOC (8) Cl.** **07-01**

(52) **U.S. Cl.** **D7/313; D7/608**

(58) **Field of Classification Search** **D7/300,**
D7/312, 313, 306, 605-608; 222/144, 146.6,
222/469, 183, 185.1, 129; 62/457.1-457.7;
215/12.1, 12.2, 13.1; 220/915.1, 915.2, 592.16,
220/592.17, 592.23, 592.27

See application file for complete search history.

(56) **References Cited**

U.S. PATENT DOCUMENTS

D208,378 S * 8/1967 Waddington D7/608
D293,409 S * 12/1987 Seike et al. D7/313
D298,602 S * 11/1988 Price D7/313

OTHER PUBLICATIONS

Igloo Products Corp., Products Brochure, 2003, Houston,
Texas.

* cited by examiner

Primary Examiner—Terry A. Wallace

(74) *Attorney, Agent, or Firm*—Leydig, Voit & Mayer, Ltd.

(57) **CLAIM**

The ornamental design for a beverage cooler, as shown and
described.

DESCRIPTION

FIG. 1 is a front side perspective view of our new beverage
cooler;

FIG. 2 is a front elevation view thereof;

FIG. 3 is a rear elevation view thereof;

FIG. 4 is a left elevation view thereof;

FIG. 5 is a right elevation view thereof;

FIG. 6 is a top plan view thereof; and,

FIG. 7 is a bottom plan view thereof.

The broken line showing is for illustrative purposes only and
forms no part of the claimed design.

1 Claim, 3 Drawing Sheets

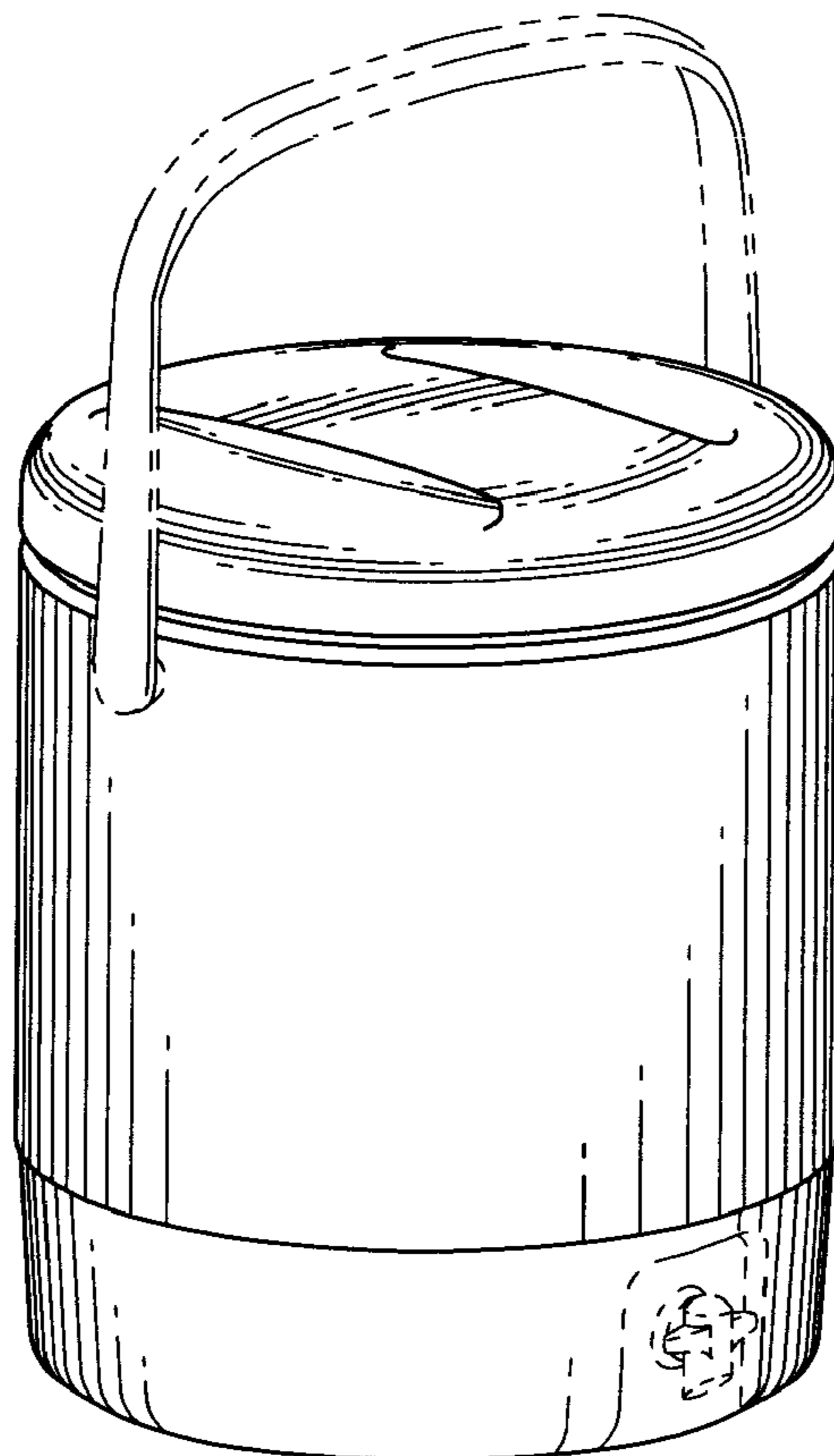

FIG. 2

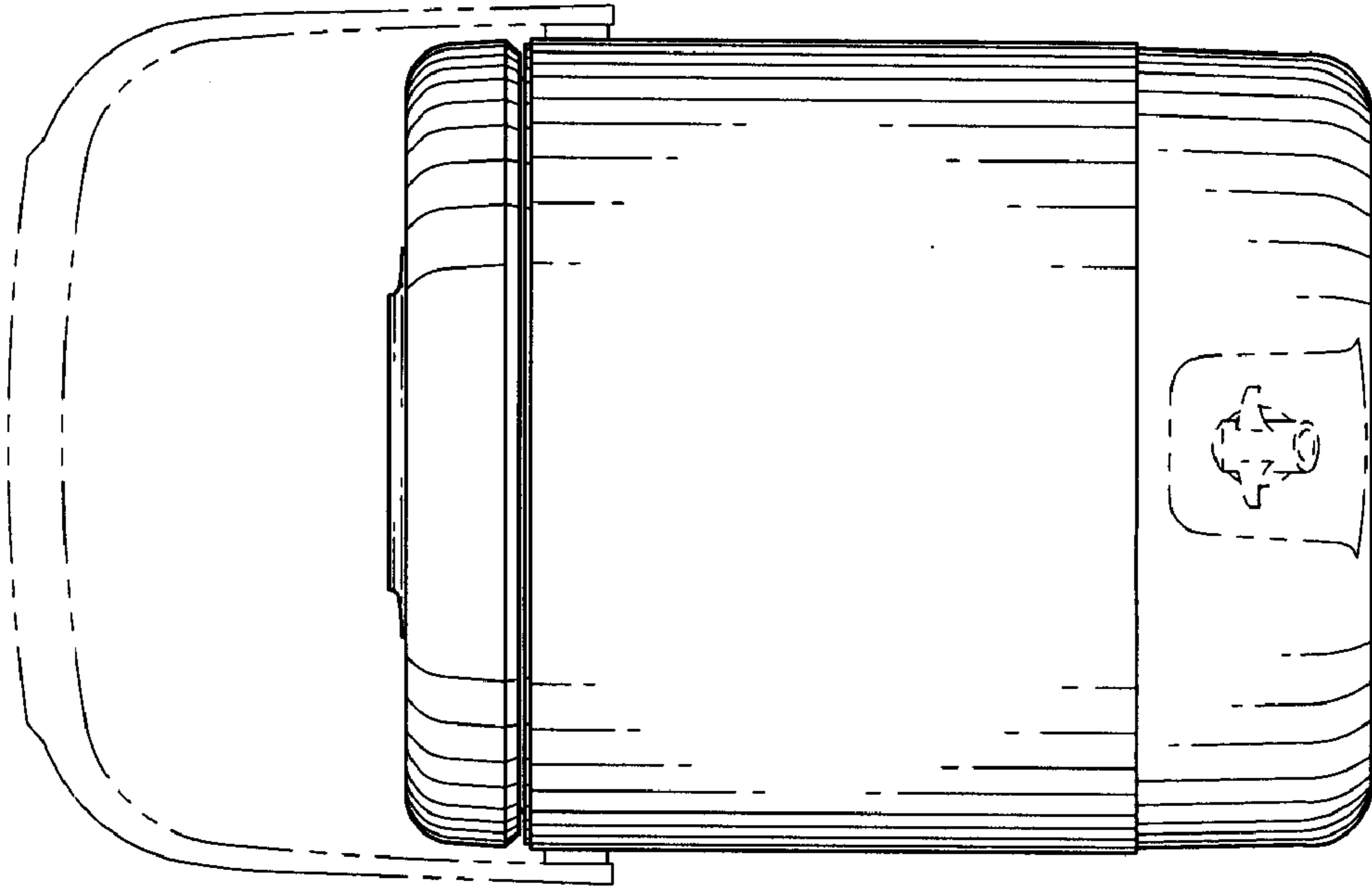
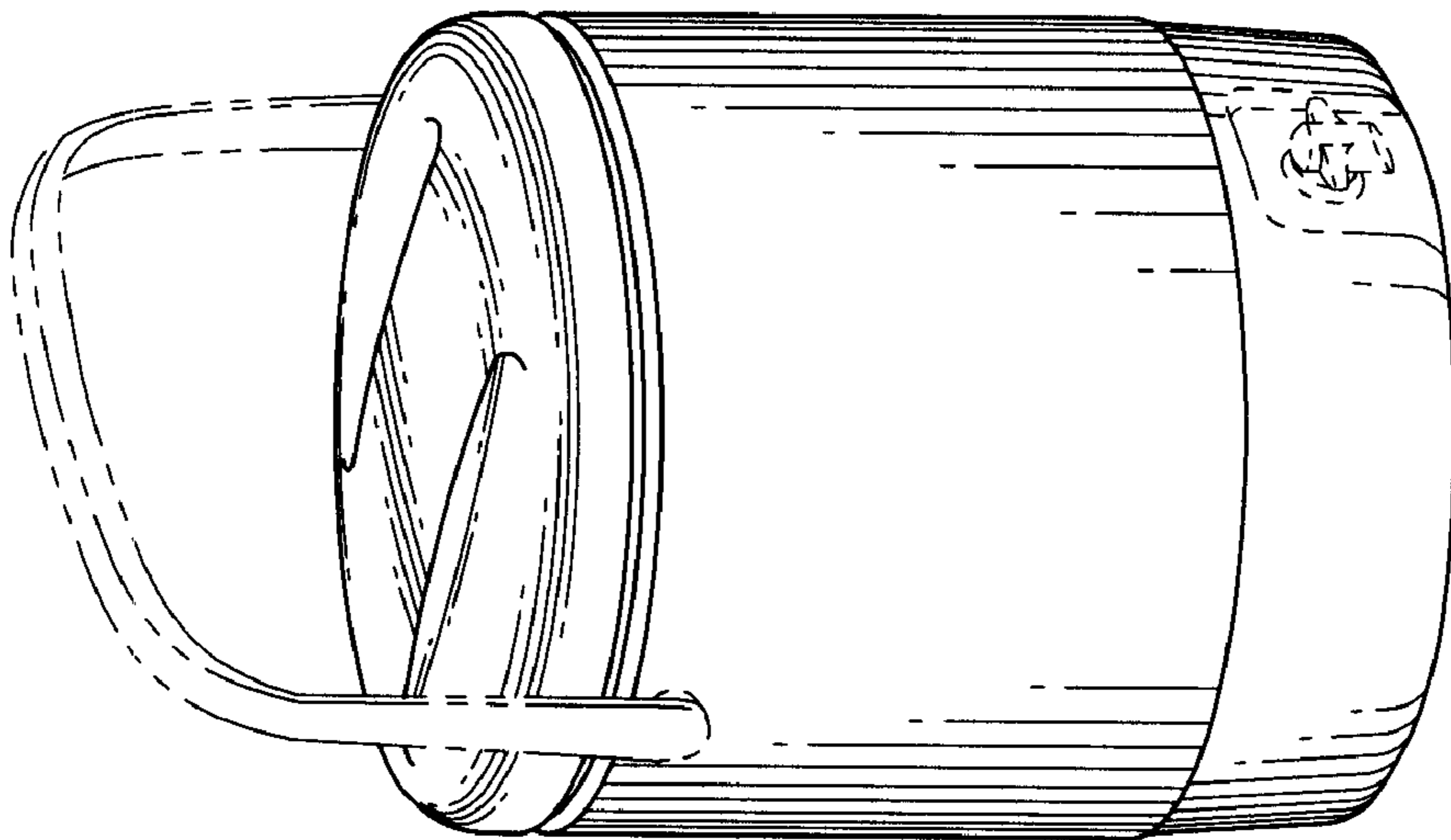

FIG. 1



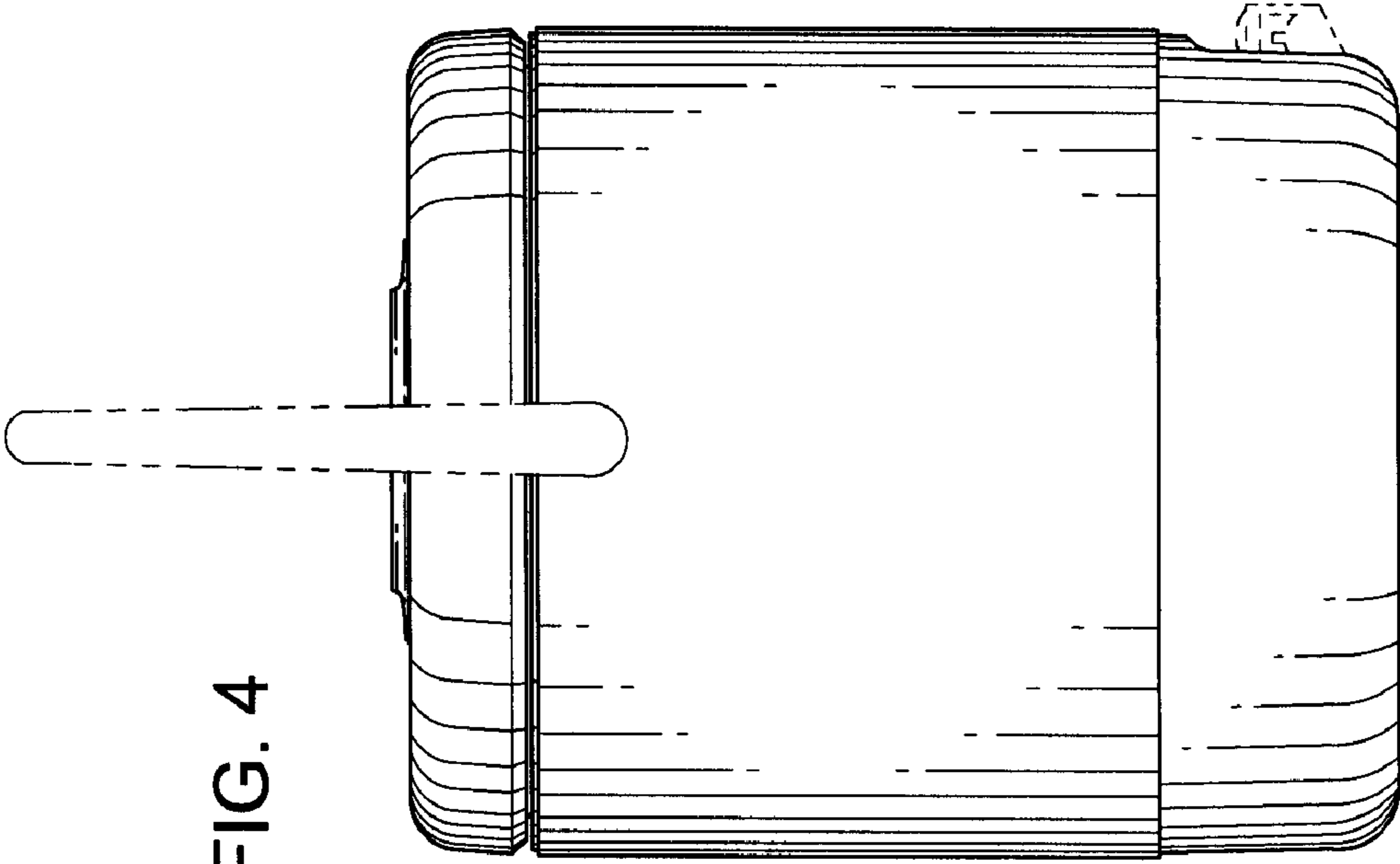

FIG. 4

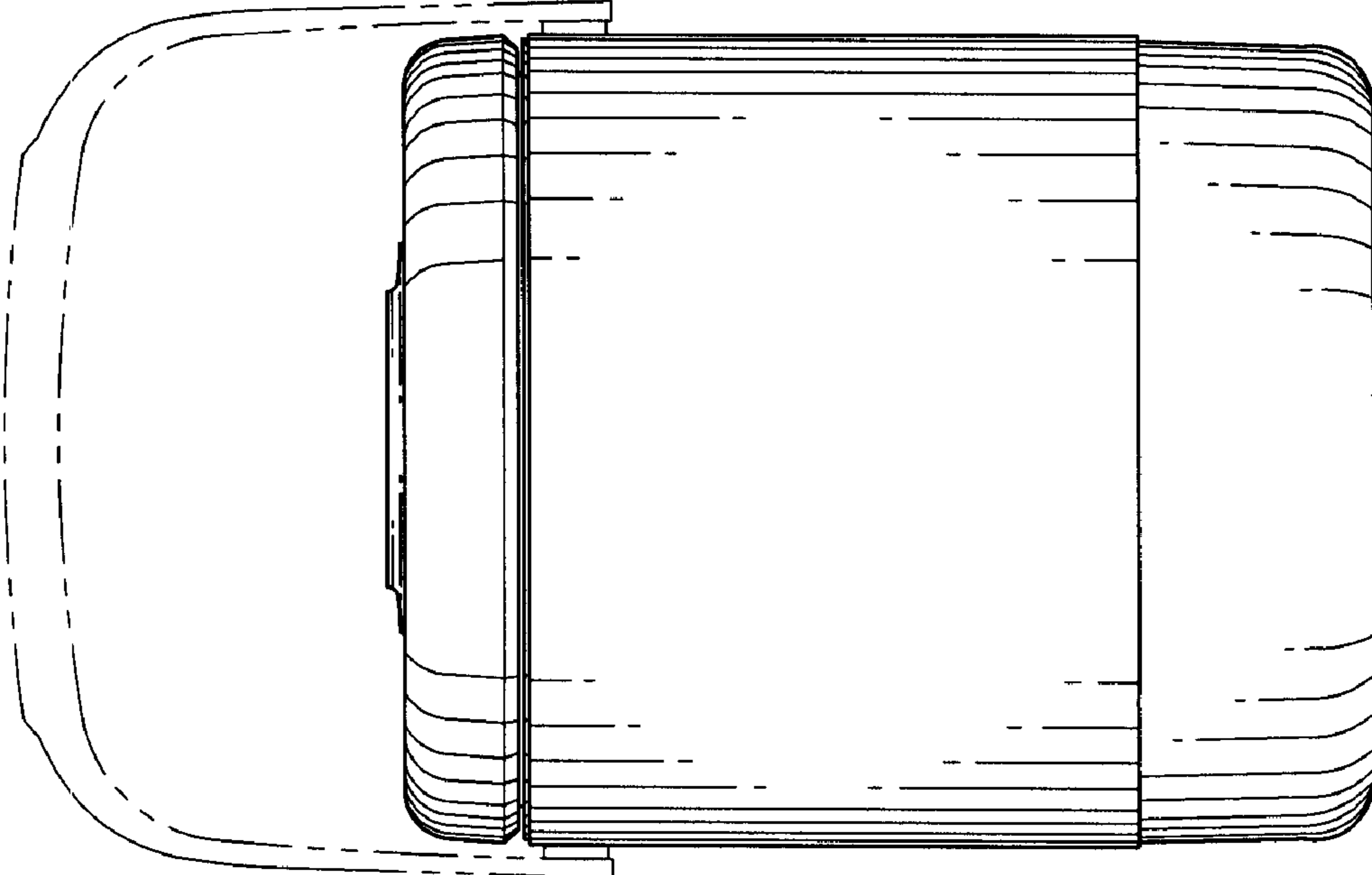

FIG. 3

FIG. 6

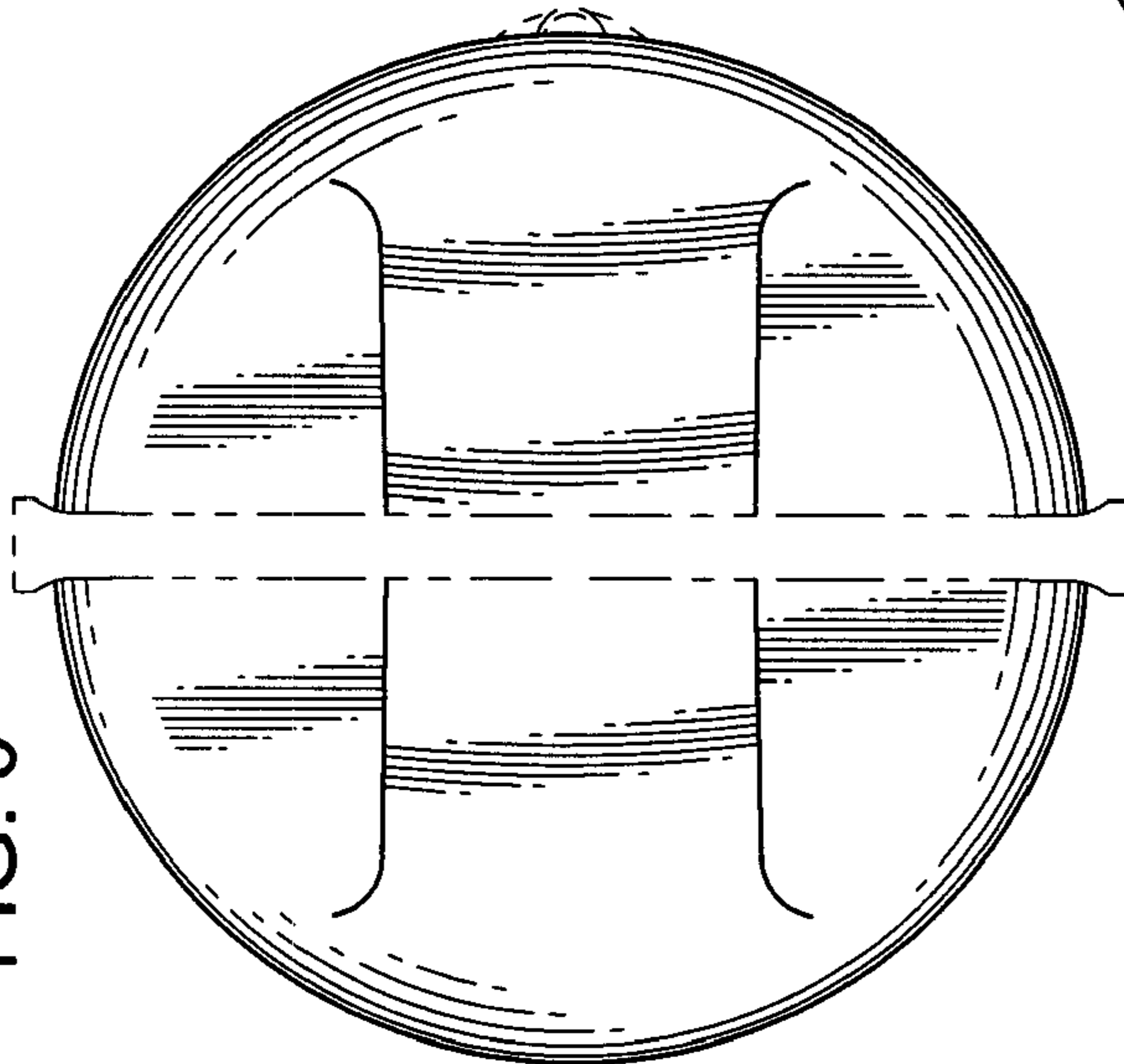

FIG. 7

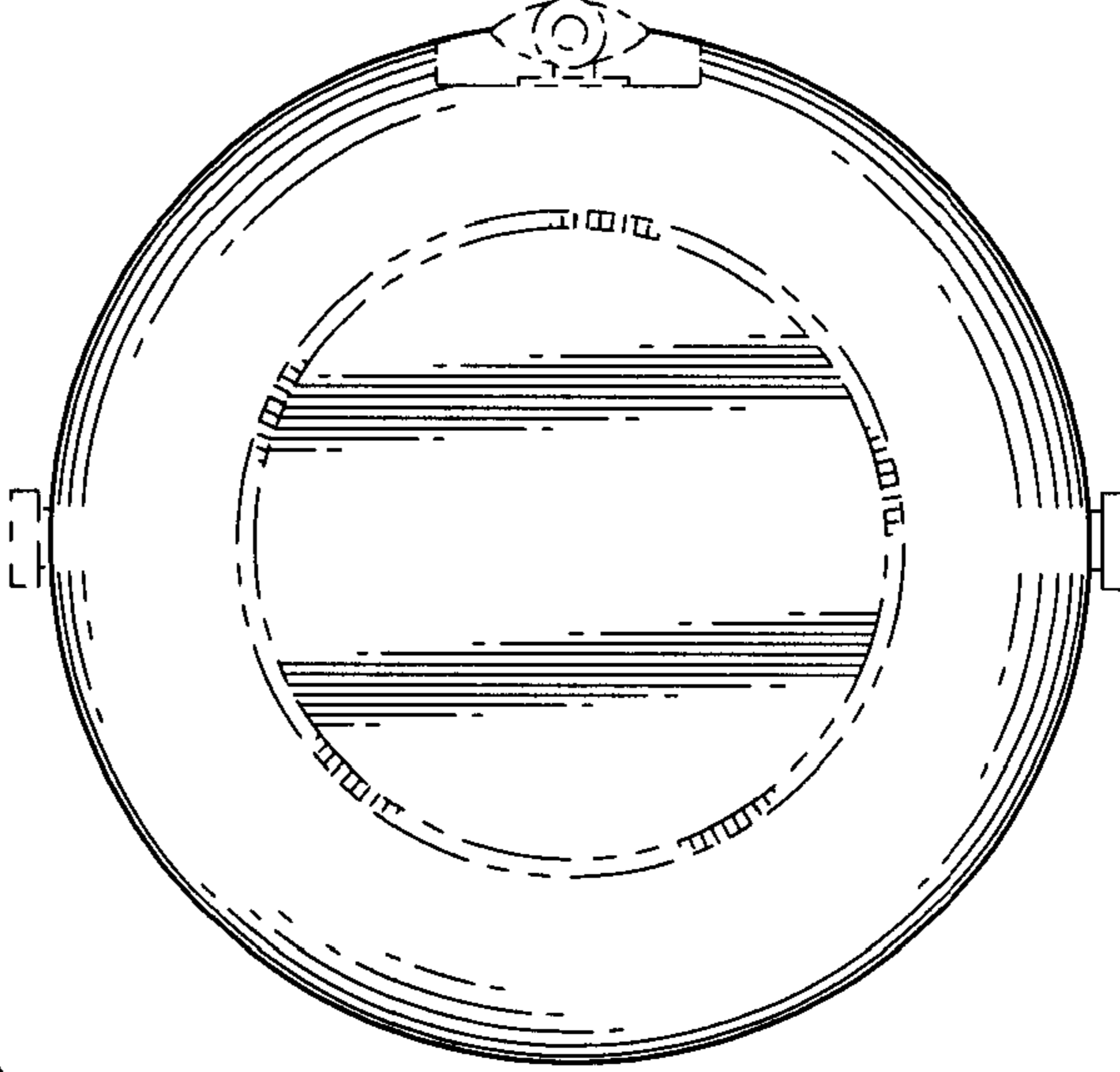

FIG. 5

