



US00D530130S

(12) **United States Design Patent**  
**Counard**

(10) **Patent No.:** **US D530,130 S**

(45) **Date of Patent:** **\*\* Oct. 17, 2006**

(54) **WINDOW SHADE**

(75) Inventor: **Kerry J. Counard**, De Pere, WI (US)

(73) Assignee: **Sports Fields Shades, LLC**, De Pere, WI (US)

(\*\*) Term: **14 Years**

(21) Appl. No.: **29/253,507**

(22) Filed: **Feb. 8, 2006**

**Related U.S. Application Data**

(62) Division of application No. 29/210,267, filed on Jul. 29, 2004.

(51) **LOC (8) Cl.** ..... **06-10**

(52) **U.S. Cl.** ..... **D6/576**

(58) **Field of Classification Search** ..... D6/576;  
D21/339, 359; D5/20; 160/84.01, 84.04,  
160/84.05, 238

See application file for complete search history.

(56) **References Cited**

**U.S. PATENT DOCUMENTS**

D59,820 S	11/1921	Cotter	
D89,205 S	2/1933	Nunn	
3,205,118 A	9/1965	Guffan	
3,580,573 A	5/1971	Noonan et al.	
D251,228 S	* 3/1979	Block et al.	..... D7/551.1
D252,599 S	* 8/1979	Carter	..... D6/388
D285,579 S	* 9/1986	Hill	..... D21/339
D321,910 S	11/1991	Brady	
D322,527 S	12/1991	Barfield	
D373,148 S	8/1996	Crow et al.	
D384,111 S	9/1997	Dougan	
5,664,780 A	9/1997	Bricker	

D416,137 S \* 11/1999 Messersmith ..... D6/303  
D488,335 S 4/2004 Kerr

\* cited by examiner

*Primary Examiner*—Holly Baynham

(74) *Attorney, Agent, or Firm*—Ryan Kromholz & Manion, S.C.

(57) **CLAIM**

The ornamental design for a window shade, as shown and described.

**DESCRIPTION**

FIG. 1 is a front view of a window shade according to the present invention in a closed position.

FIG. 2 is a perspective view of a window shade according to the present invention in a closed position.

FIG. 3 is a side view of a window shade according to the present invention is an open position.

FIG. 4 is a bottom view of the window shade of FIG. 2.

FIG. 5 is a front view of a first embodiment of a window shade according to the present invention in an open position.

FIG. 6 is a front view of a second embodiment of a window shade according to the present invention in an open position.

FIG. 7 is a front view of a third embodiment of a window shade according to the present invention in an open position.

FIG. 8 is a front view of a fourth embodiment of a window shade according to the present invention in an open position;

and,

FIG. 9 is a perspective view of the embodiment of the window shade of FIG. 6.

The broken lines showing of a window, back portion of the shade, and on the front portion of the shade in FIGS. 1–9 are for illustrative purposes only and form no part of the claimed design.

**1 Claim, 4 Drawing Sheets**

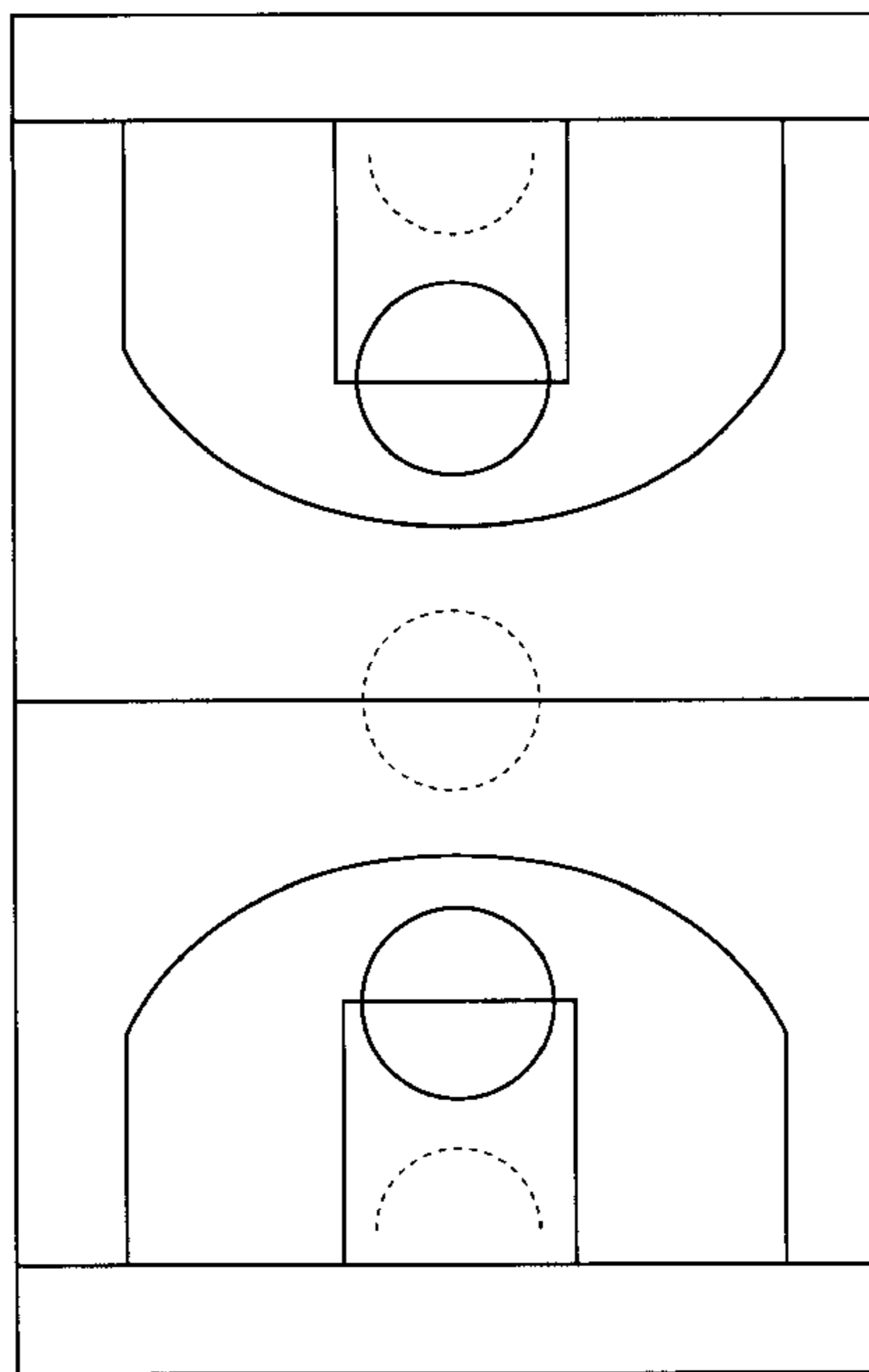
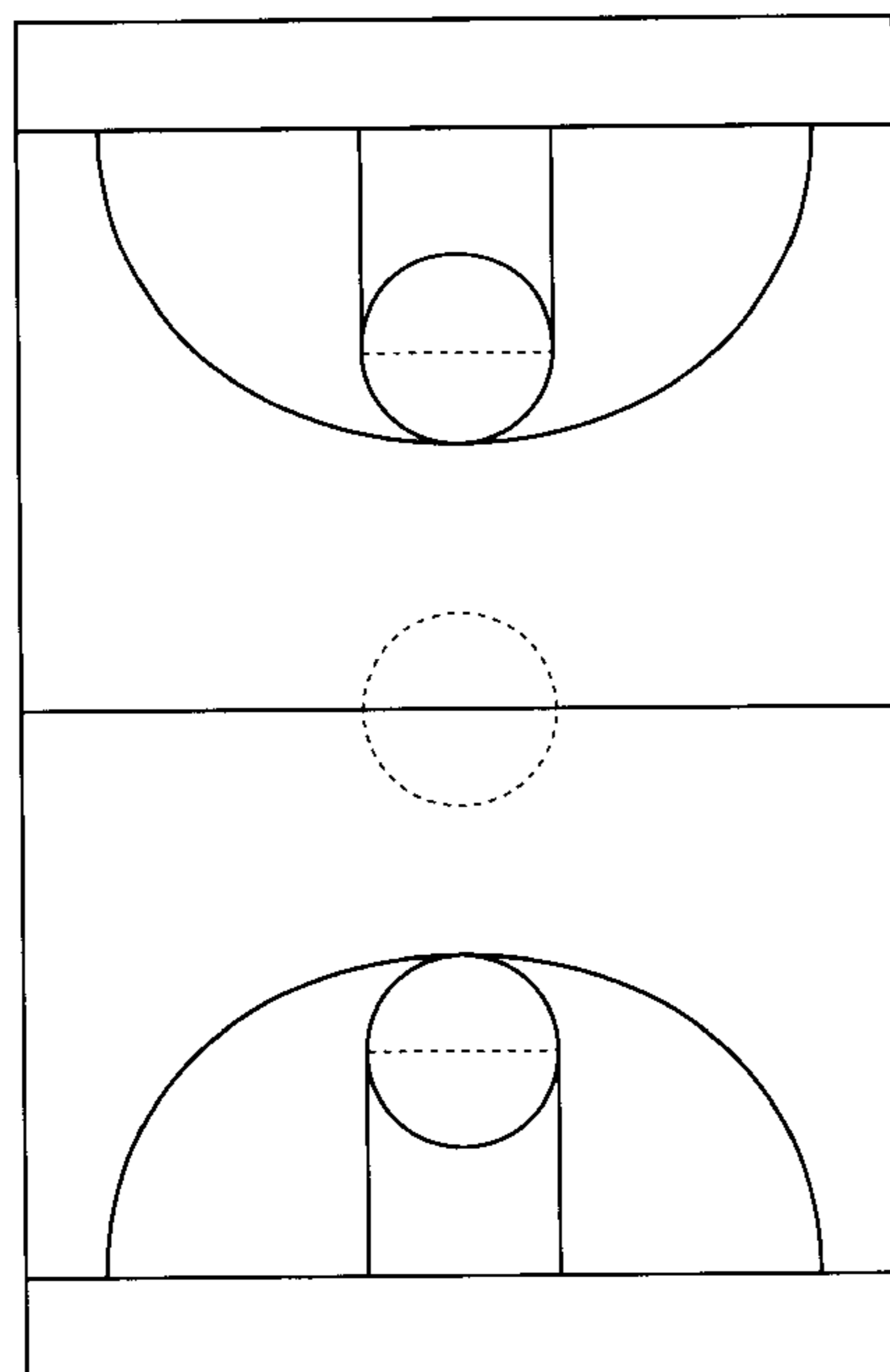

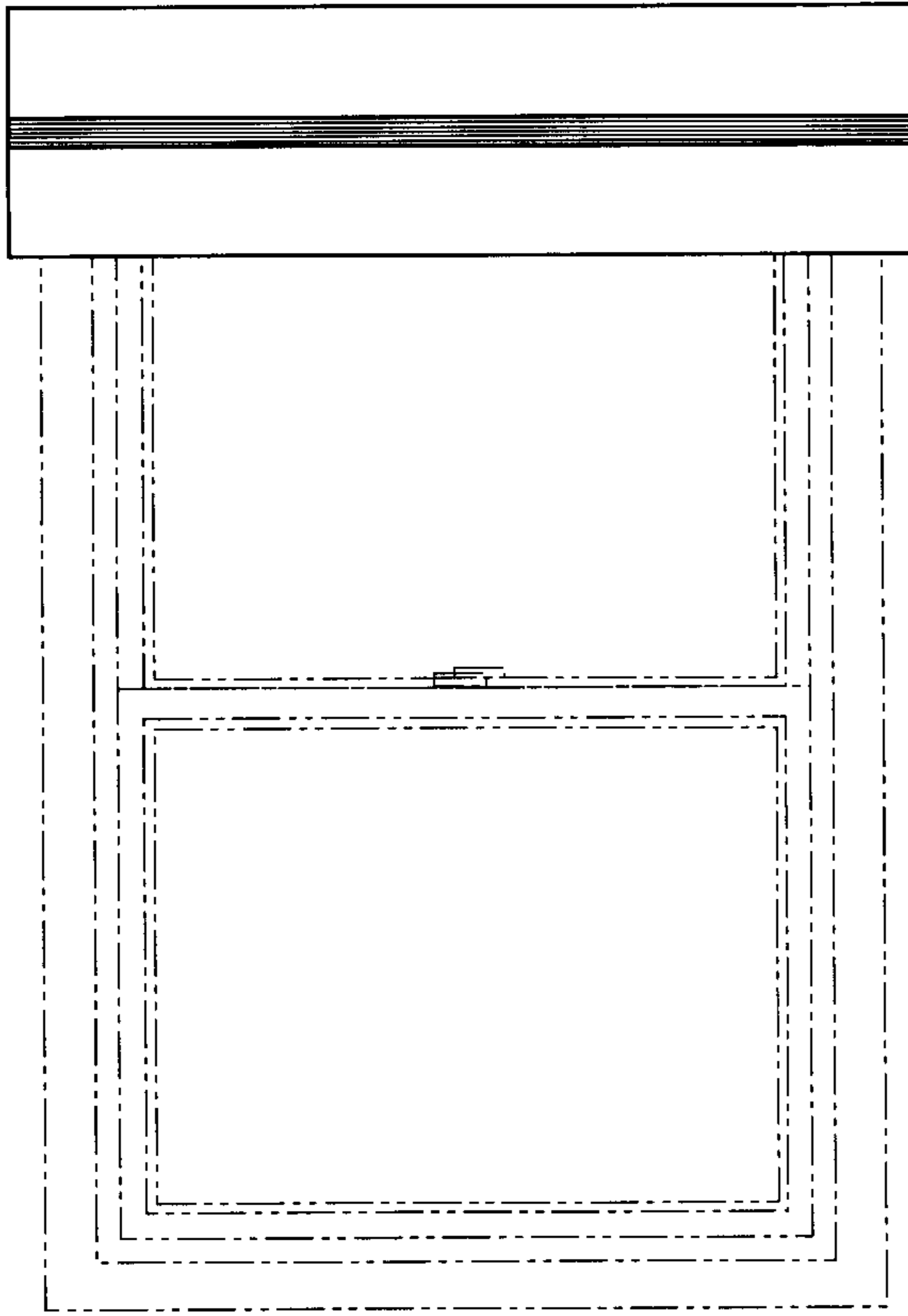

Fig. 1

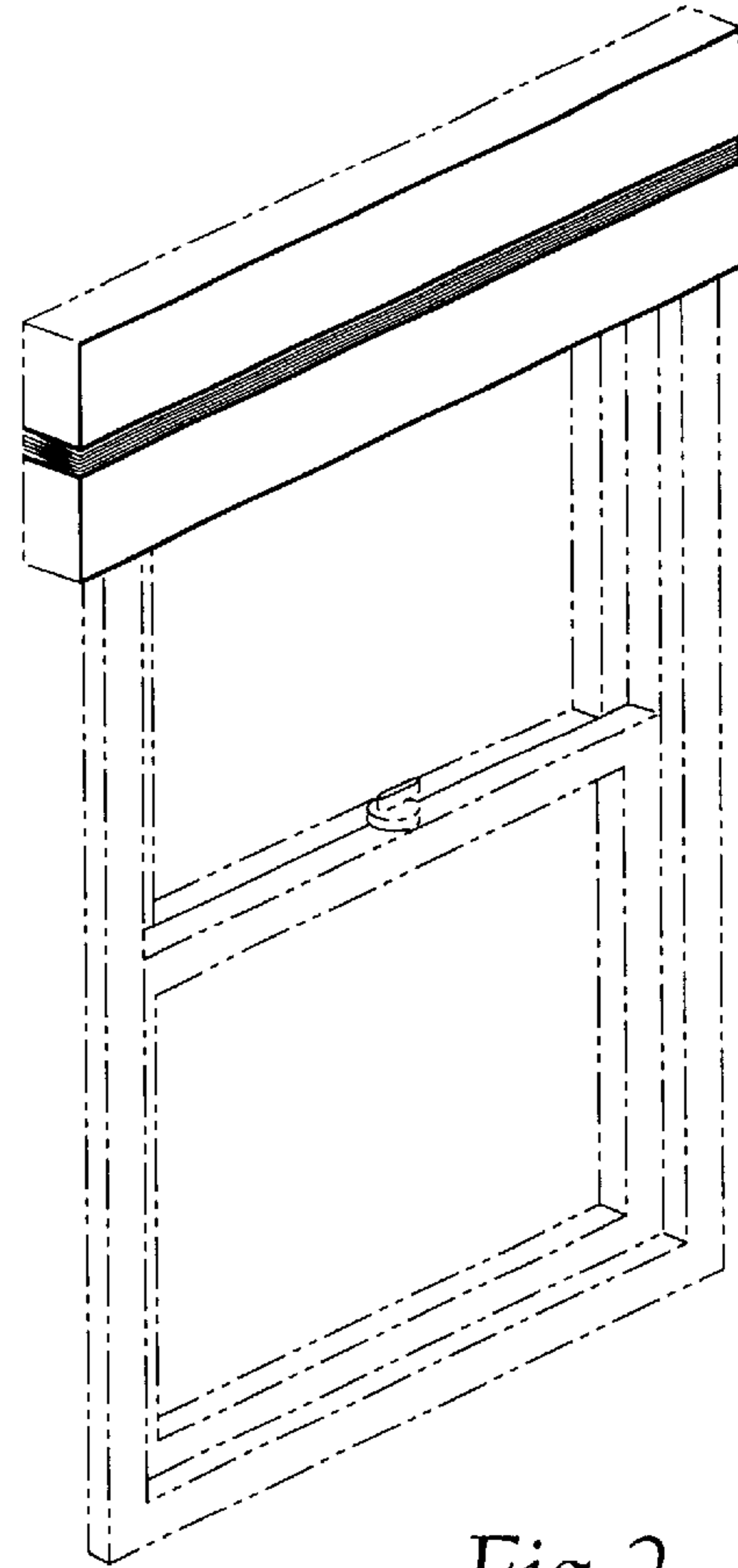

Fig. 2



Fig. 3

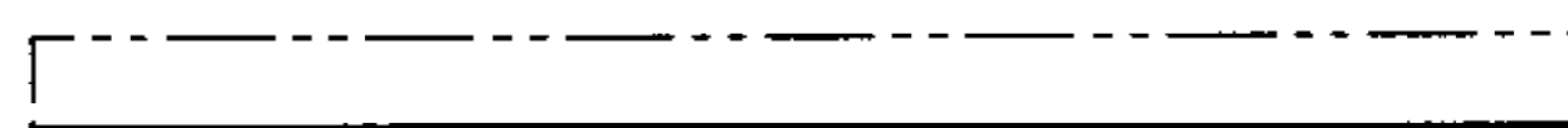

Fig. 4

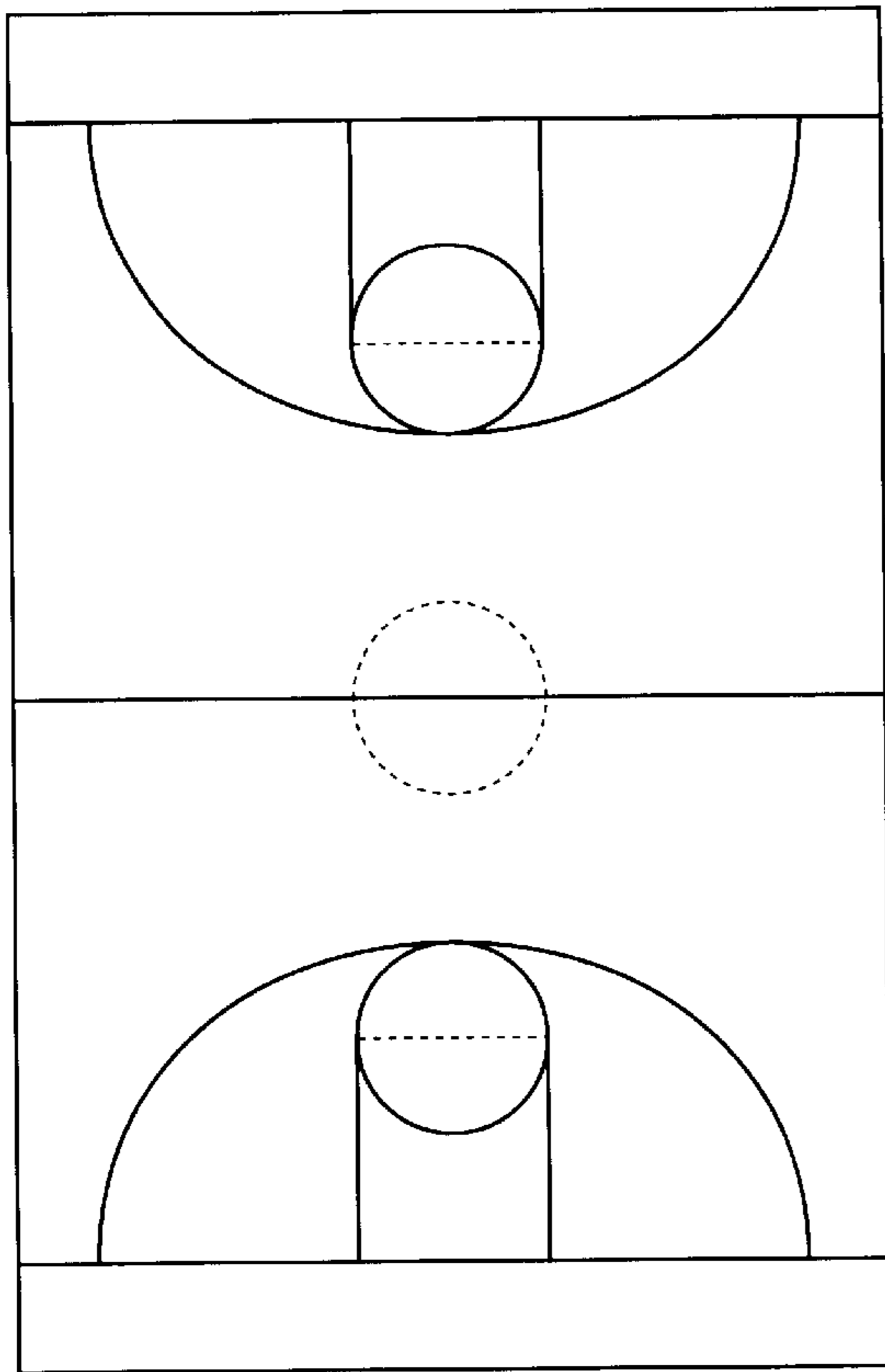
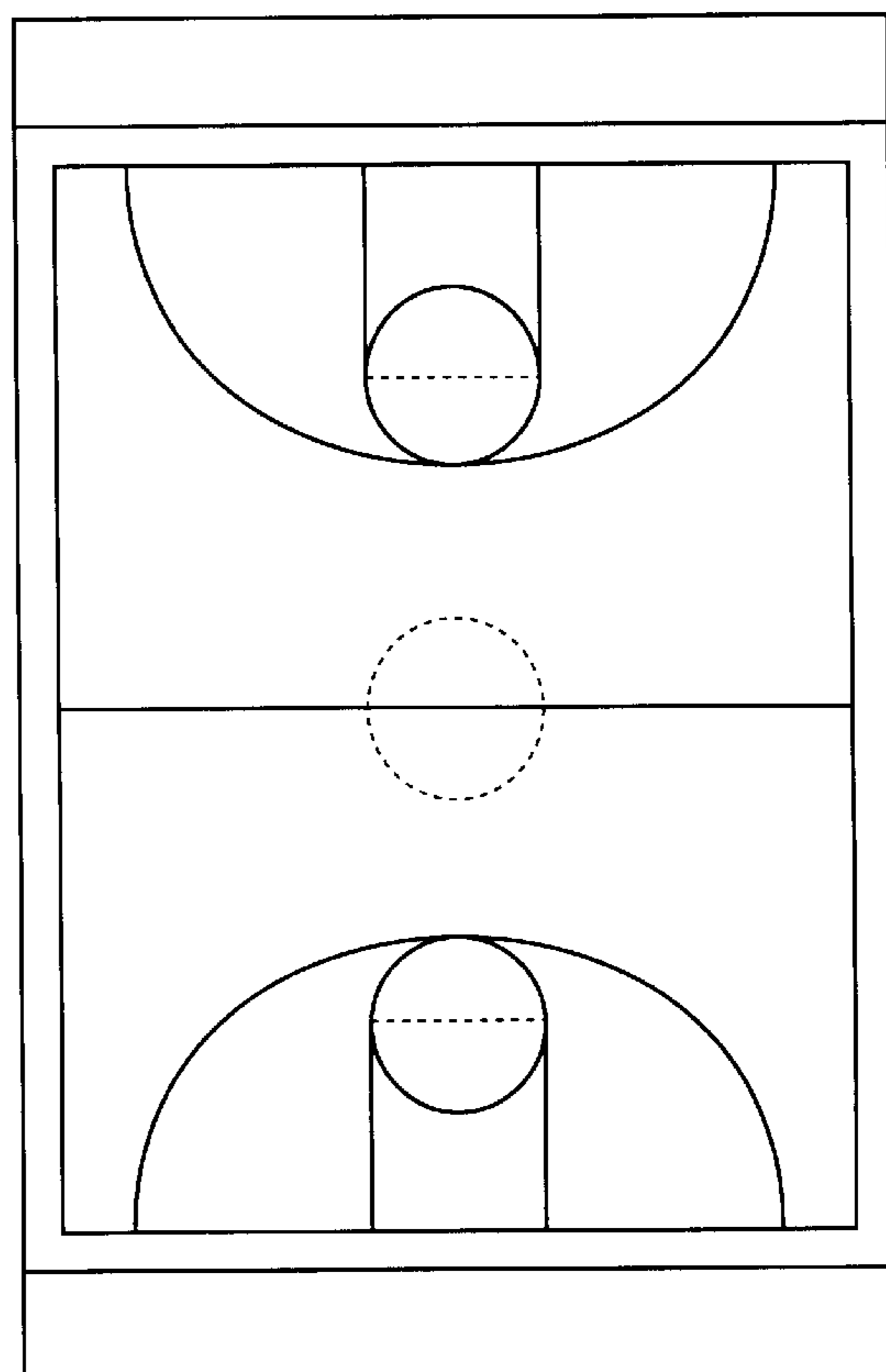

Fig. 5

Fig. 6



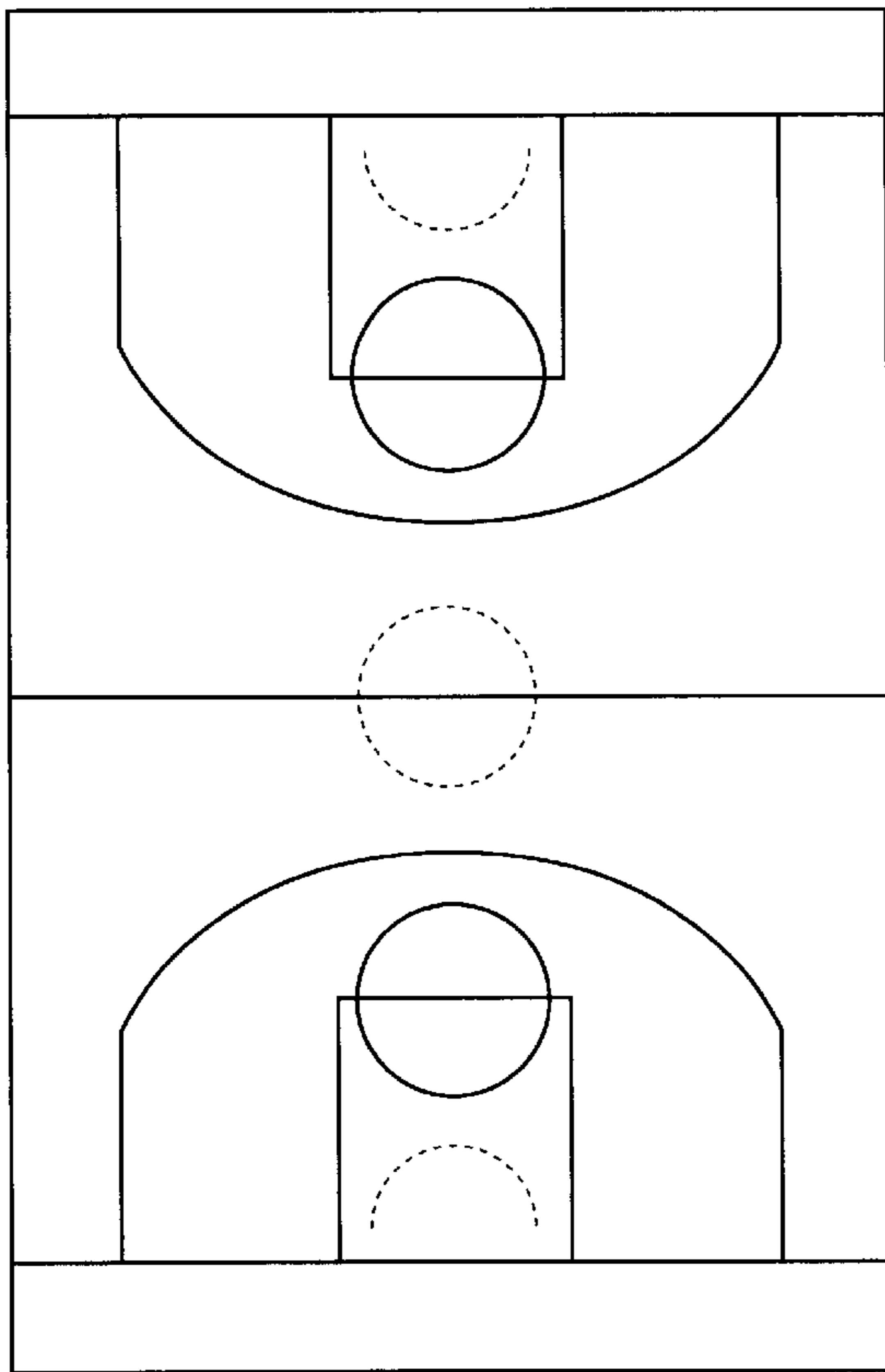
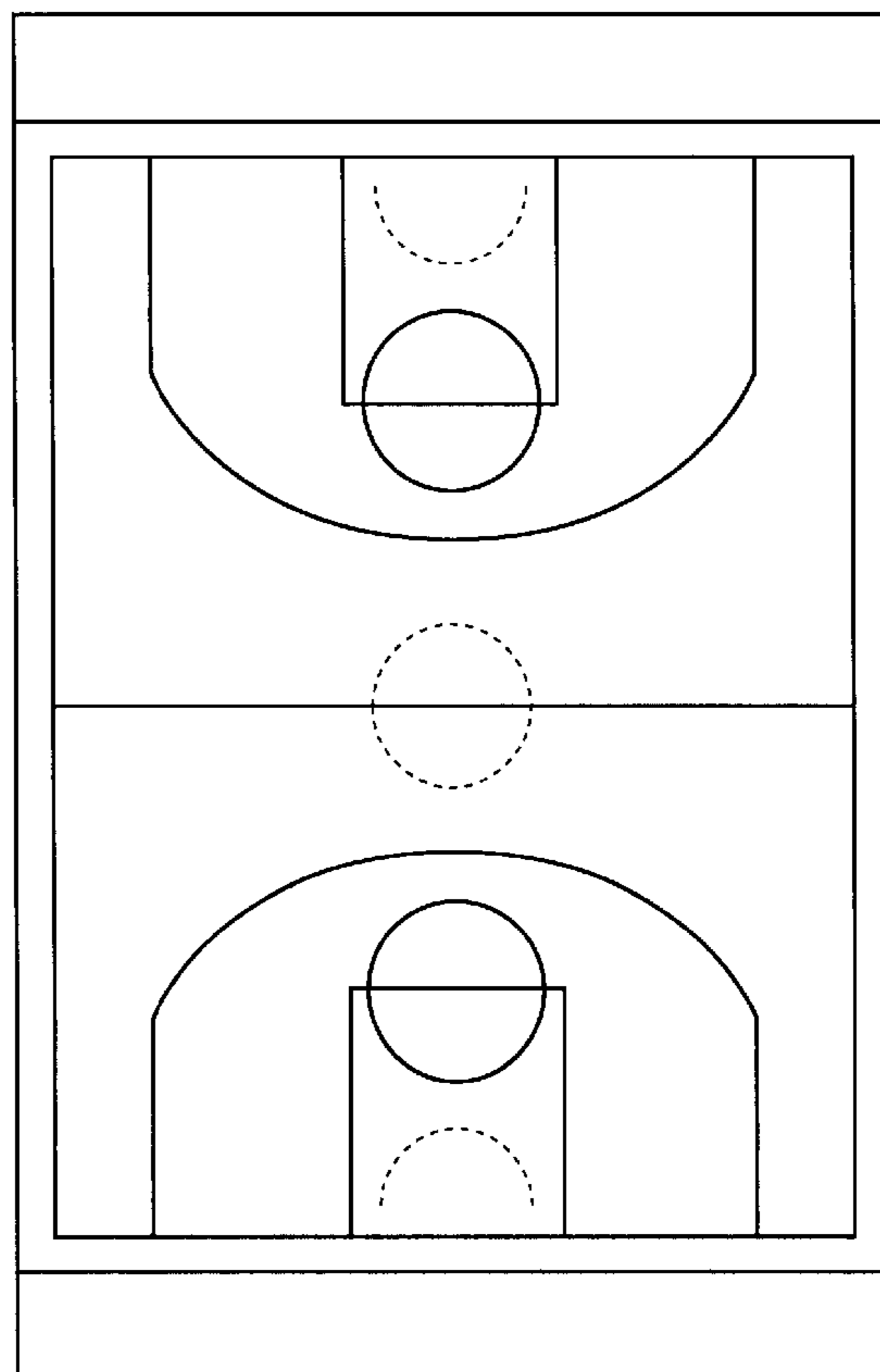

Fig. 7

Fig. 8



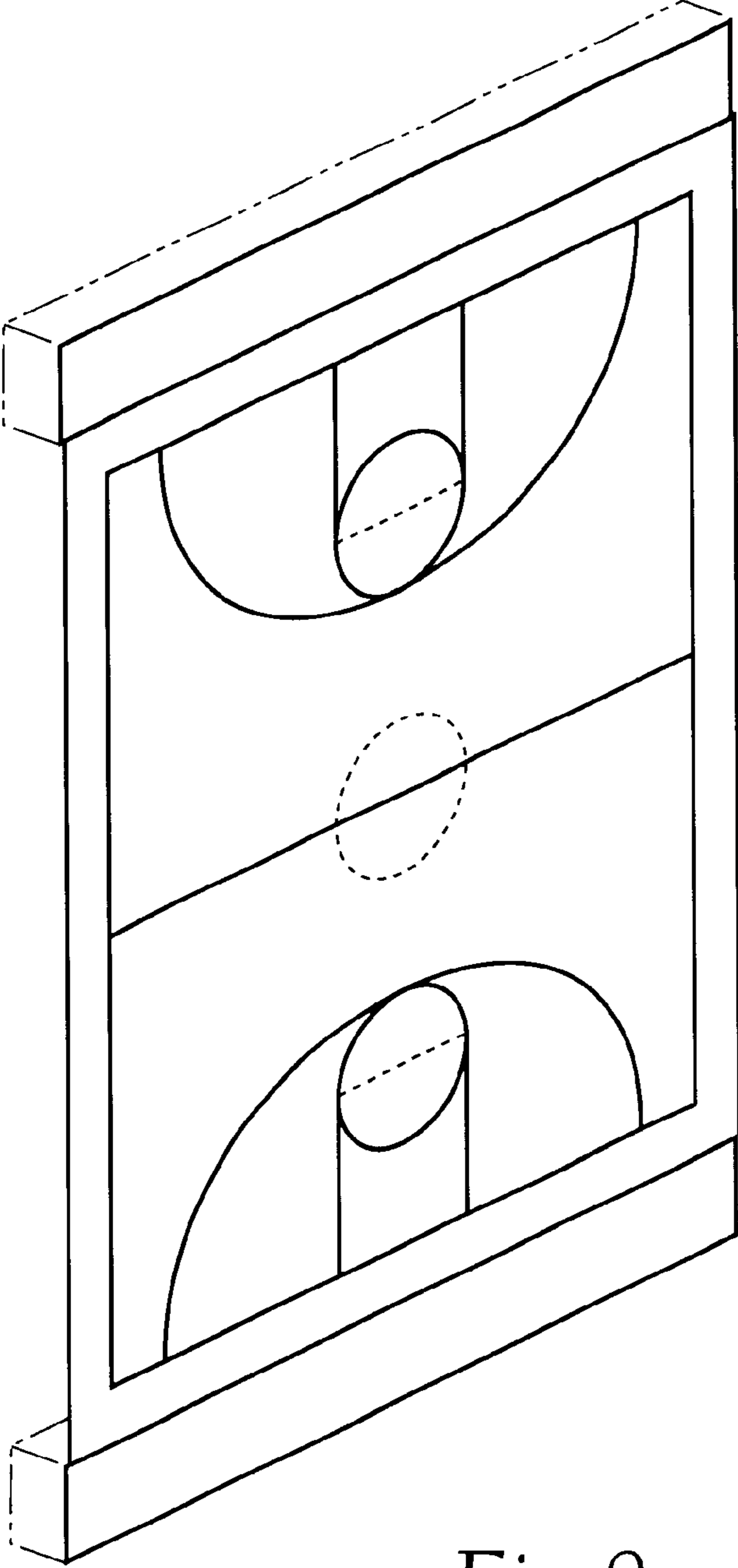

Fig. 9