



US00D530118S

(12) **United States Design Patent** (10) **Patent No.:** **US D530,118 S**
Del Castillo et al. (45) **Date of Patent:** **** Oct. 17, 2006**

(54) **MEDIA ACCESS CENTER**

(75) Inventors: **Dennis Del Castillo**, Alhambra, CA (US); **Daniel Kim**, Sacramento, CA (US)

(73) Assignee: **Accride International Inc.**, Santa Fe Springs, CA (US)

(**) Term: **14 Years**

(21) Appl. No.: **29/227,318**

(22) Filed: **Apr. 7, 2005**

(51) **LOC (8) Cl.** **06-04**

(52) **U.S. Cl.** **D6/479; D6/430; D6/630**

(58) **Field of Classification Search** D6/429–431, D6/436, 473–479, 630; 108/93; 211/186, 211/188; 312/321.5, 322, 323

See application file for complete search history.

(56) **References Cited**

U.S. PATENT DOCUMENTS

3,432,216	A	*	3/1969	Yang	312/111
4,202,586	A	*	5/1980	Oplinger	312/107
D264,658	S	*	6/1982	de Polo et al.	D6/436
D341,503	S	*	11/1993	Leonard	D6/477
D361,219	S	*	8/1995	Luymes	D6/432
D387,236	S	*	12/1997	Madonna	D6/479
D391,783	S	*	3/1998	Neufeld	D6/437
5,769,516	A	*	6/1998	Aguilera	312/321.5
D403,180	S	*	12/1998	Gelman	D6/478
D413,742	S	*	9/1999	Borsani	D6/430
6,076,906	A	*	6/2000	Royal	312/321.5
D433,264	S	*	11/2000	Lindeqvist et al.	D6/631
D492,860	S	*	7/2004	Bertoncini	D6/470
2004/0232810	A1	*	11/2004	Kreyenkamp	312/322

OTHER PUBLICATIONS

Middle Atlantic Products, Inc., SRSR Series 19" Rotating Sliding Rail, Copyright 2000/2005, 2 pages, <http://www-middleatlantic.com/enclosure/roll/srsr.htm>.

Avrak, Inc., AVträk Rotating AV Racks, Copyright 2005, 1 page, <http://www.avrak.com/main/avtrak/avtrak.html>.

* cited by examiner

Primary Examiner—Cathron C. Brooks

(74) *Attorney, Agent, or Firm*—Christie, Parker & Hale, LLP

(57) **CLAIM**

The ornamental design for media access center, as shown and described.

DESCRIPTION

FIG. 1 is a perspective view of the front and right side of the media access center.

FIG. 2 is a perspective view of the front and right hand side of the media access center, taken from the bottom toward the top.

FIG. 3 is a perspective view of the rear and right hand side of the media access center.

FIG. 4 is a rear elevation view of the media access center. FIG. 5 is a perspective view of the front and right hand side of the media access center, with the interior console extended.

FIG. 6 is a perspective view of the front and right hand side of the media access center taken from the bottom toward the top, with the interior console extended.

FIG. 7 is a perspective view of the rear and left side of the media access center, with the interior console extended.

FIG. 8 is a right side elevation of the media access center, with the interior console extended, the left hand side being a mirror image of the right hand side.

FIG. 9 is a rear elevation view of the media access center with the interior console extended.

FIG. 10 is a perspective view of the front and right hand side of the media access center with the interior console extended and rotated 90° to the left.

FIG. 11 is a right hand side elevation view of the media access center as shown in FIG. 10.

FIG. 12 is a front elevation view of the media access center as shown in FIG. 11.

FIG. 13 is a perspective view of the front and right side of the media access center taken from the bottom toward the top with the interior console extended and rotated 90° to the left; and,

FIG. 14 is a rear elevation view of the media access center as shown in FIG. 13.

1 Claim, 14 Drawing Sheets

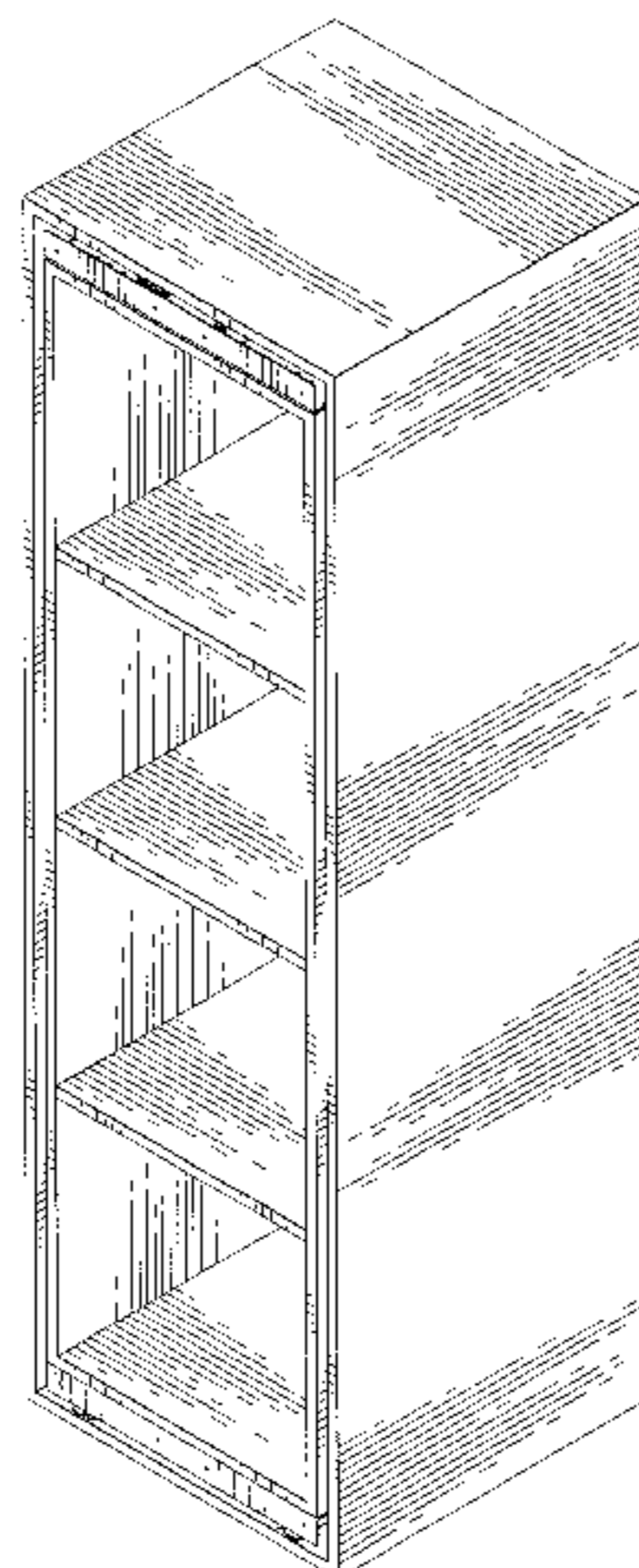

FIG. 1

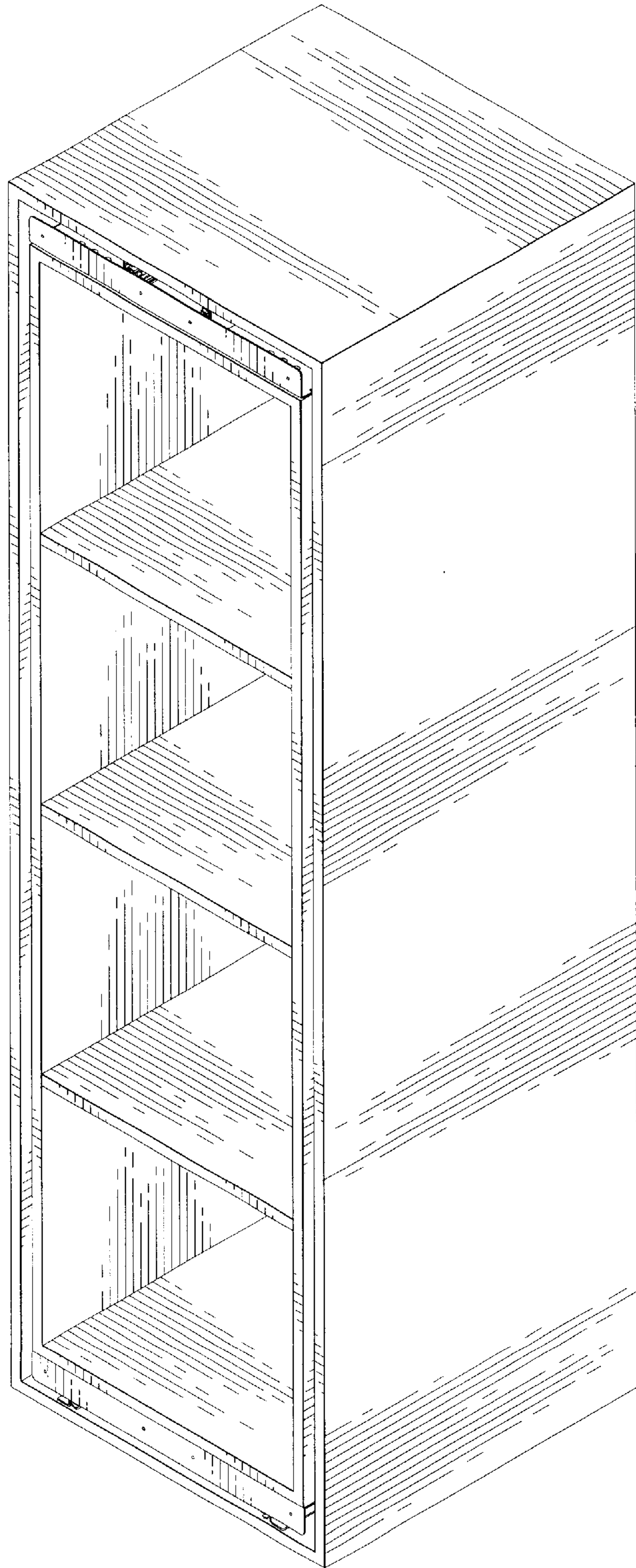

FIG. 2

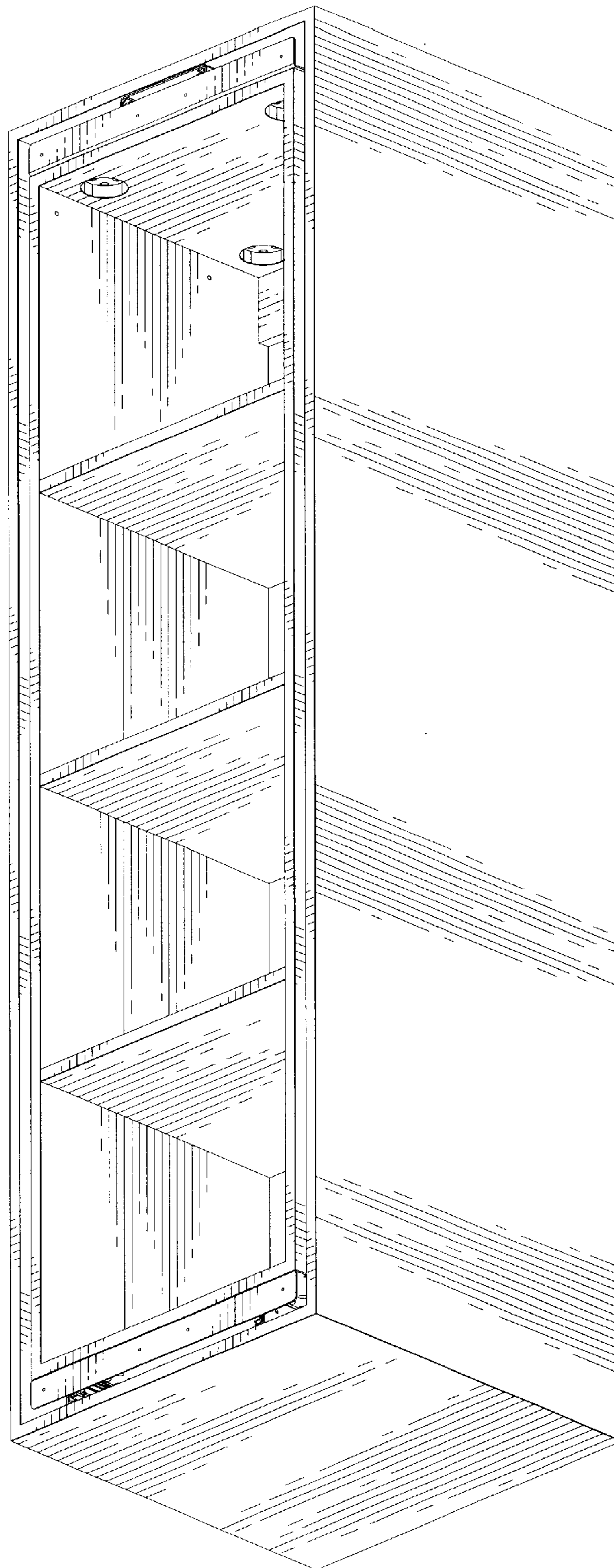

FIG. 3

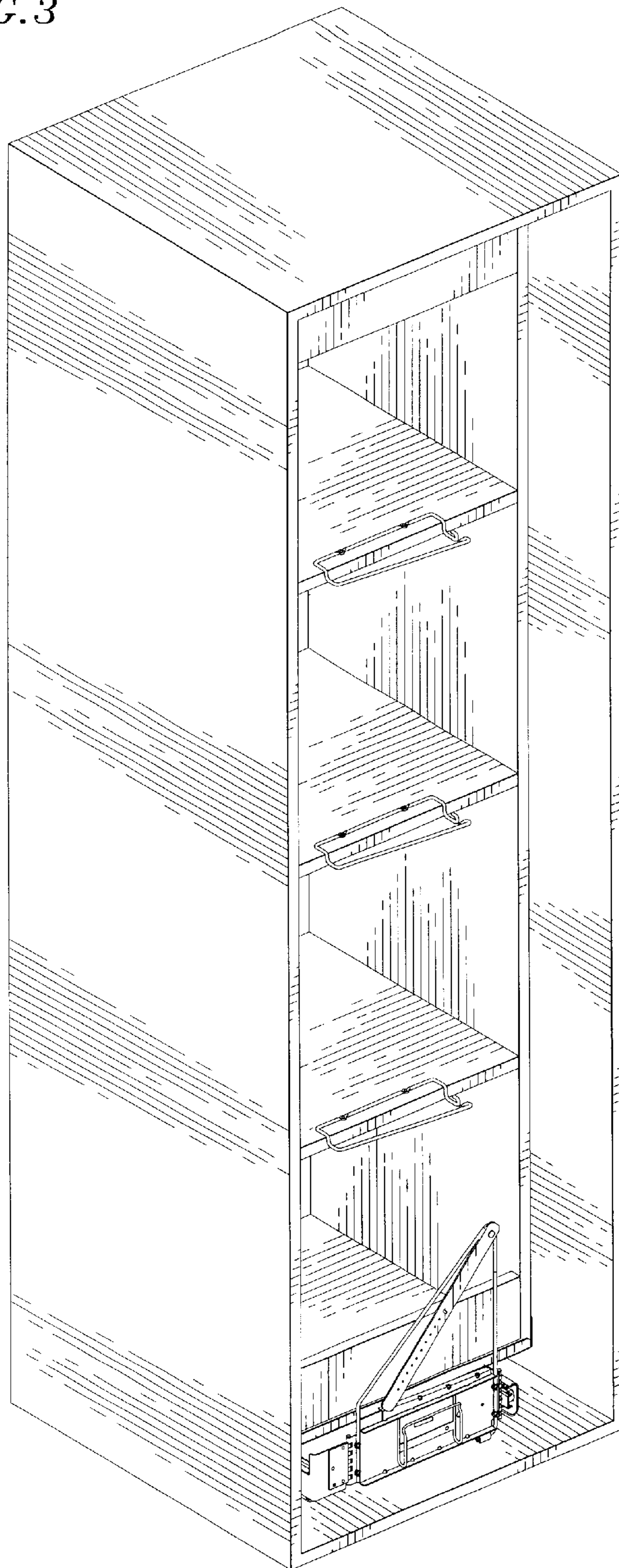

FIG. 4

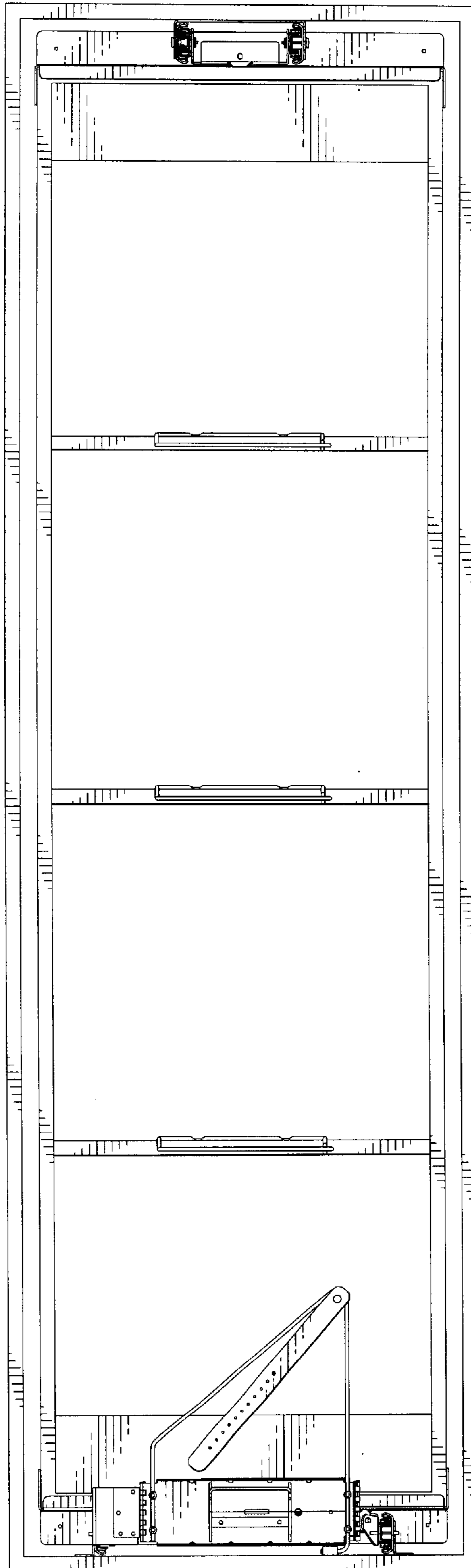

FIG. 5

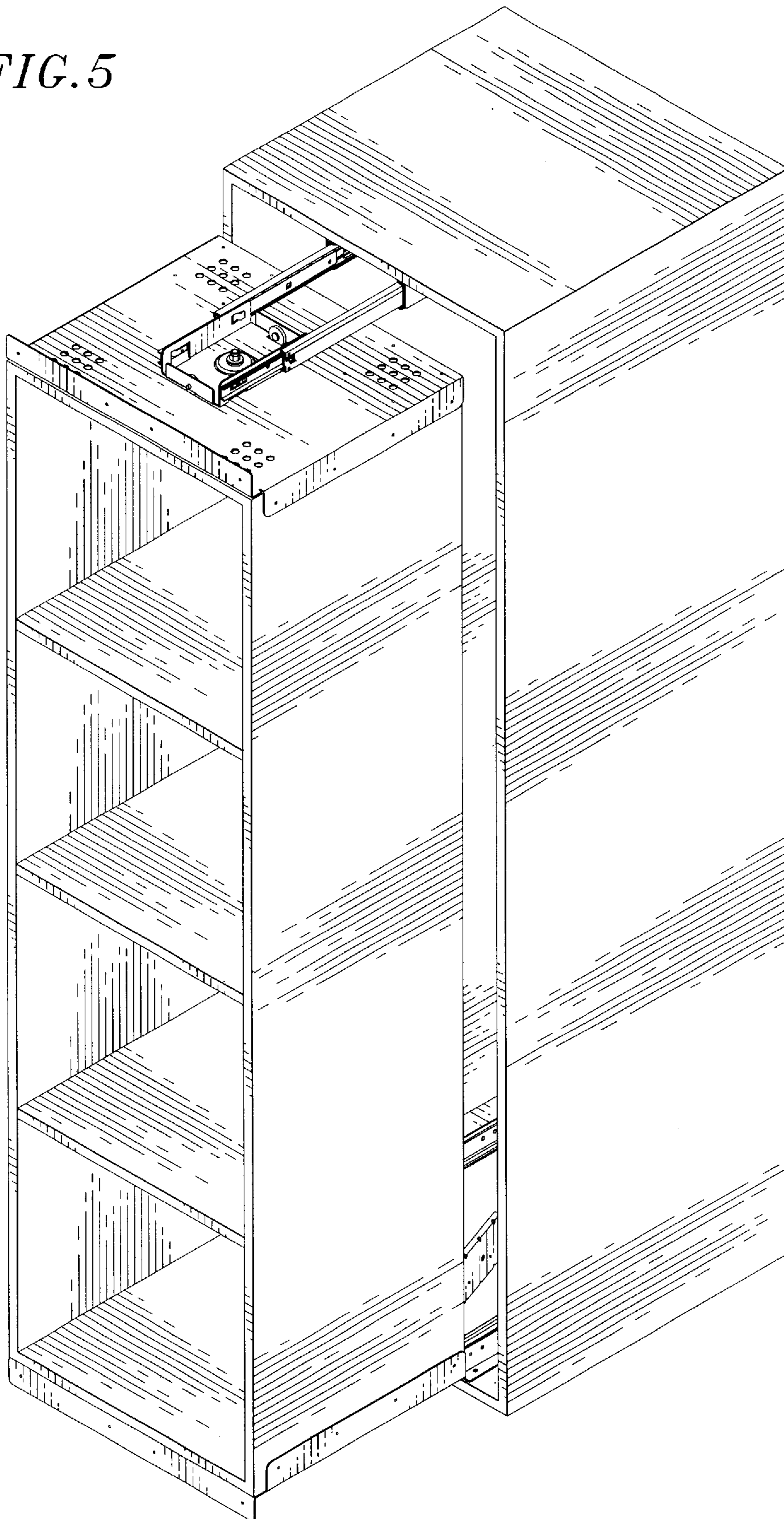

FIG. 6

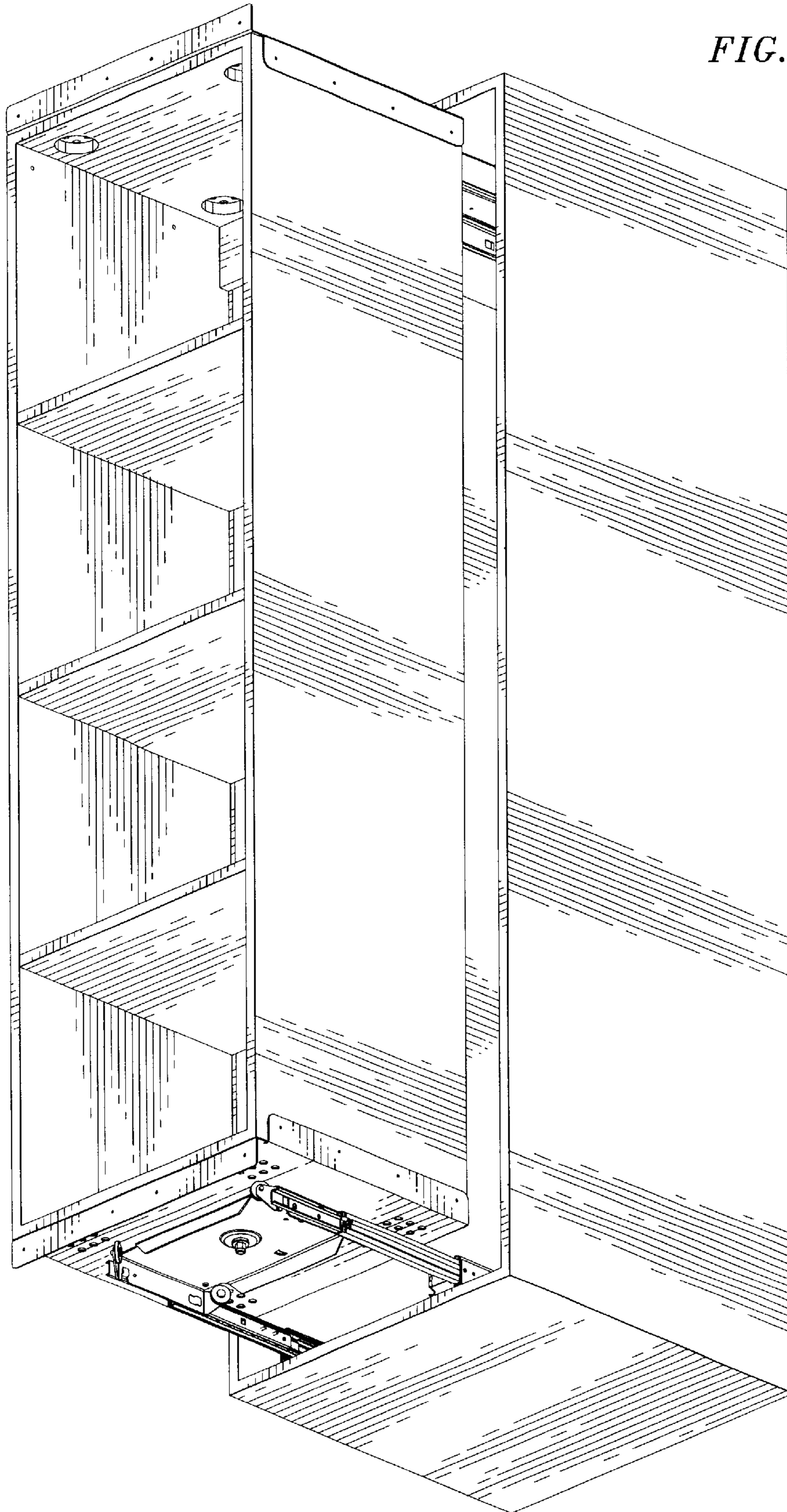

FIG. 7

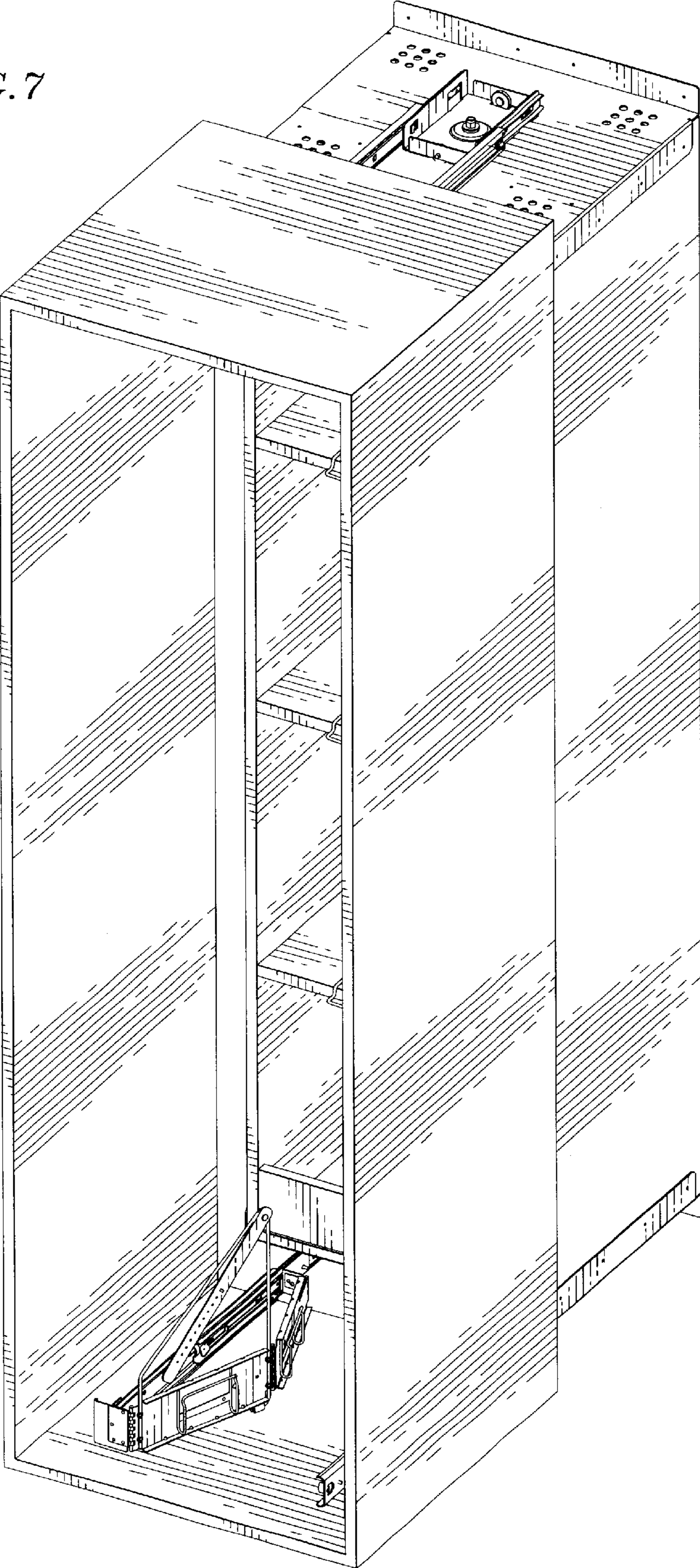

FIG. 8

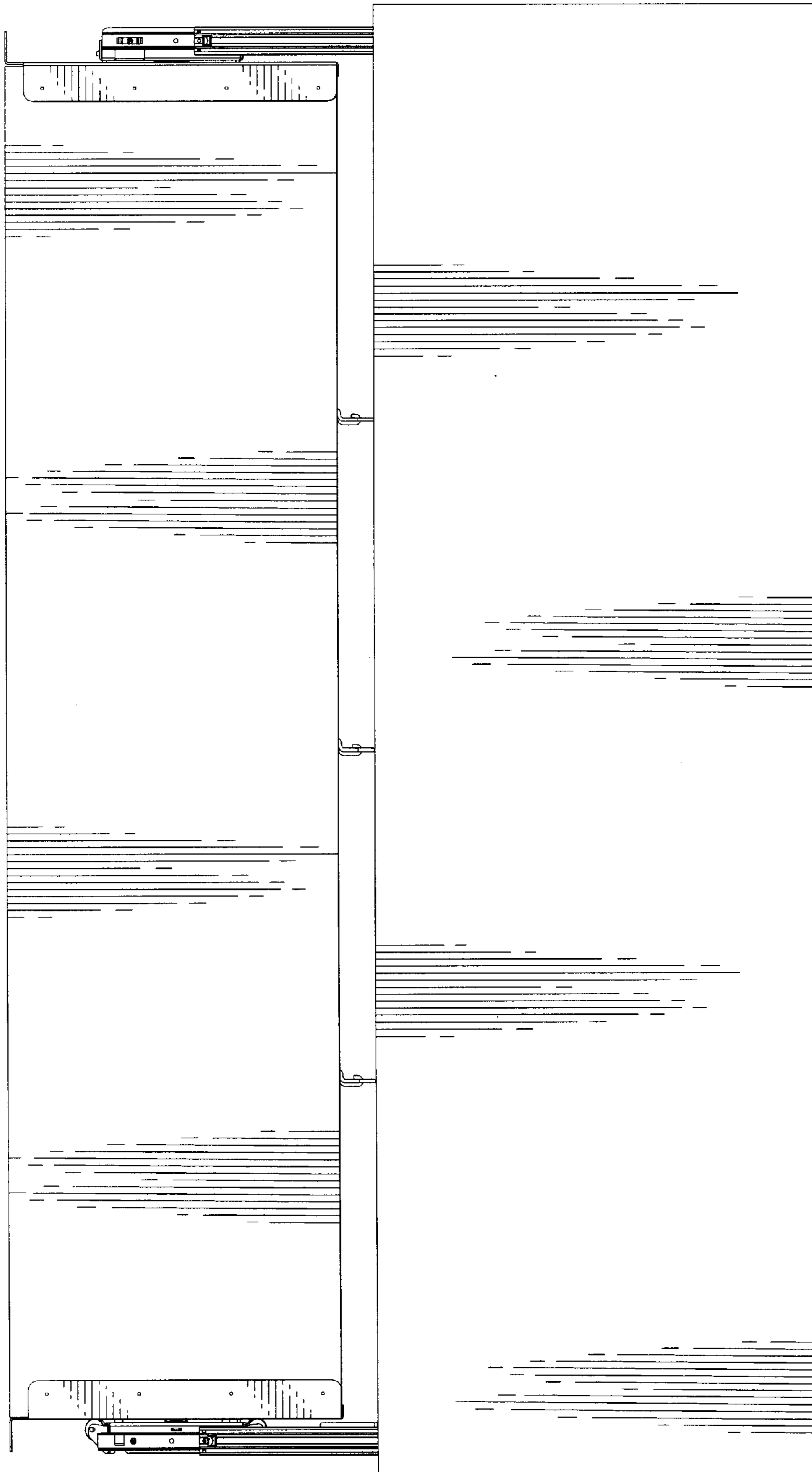

FIG. 9

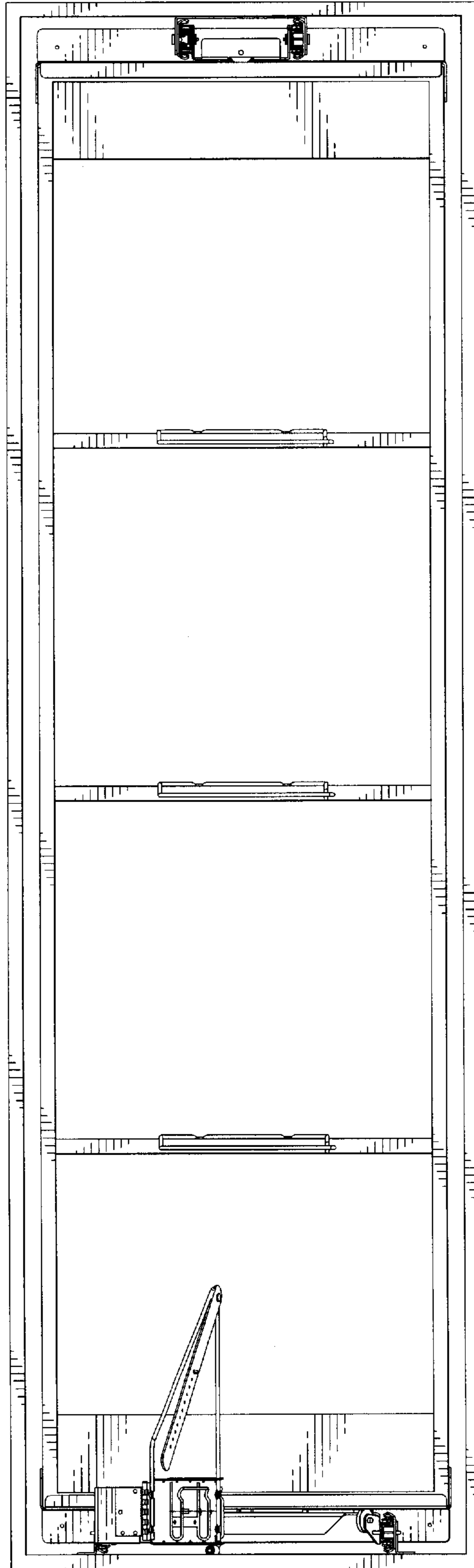

FIG. 10

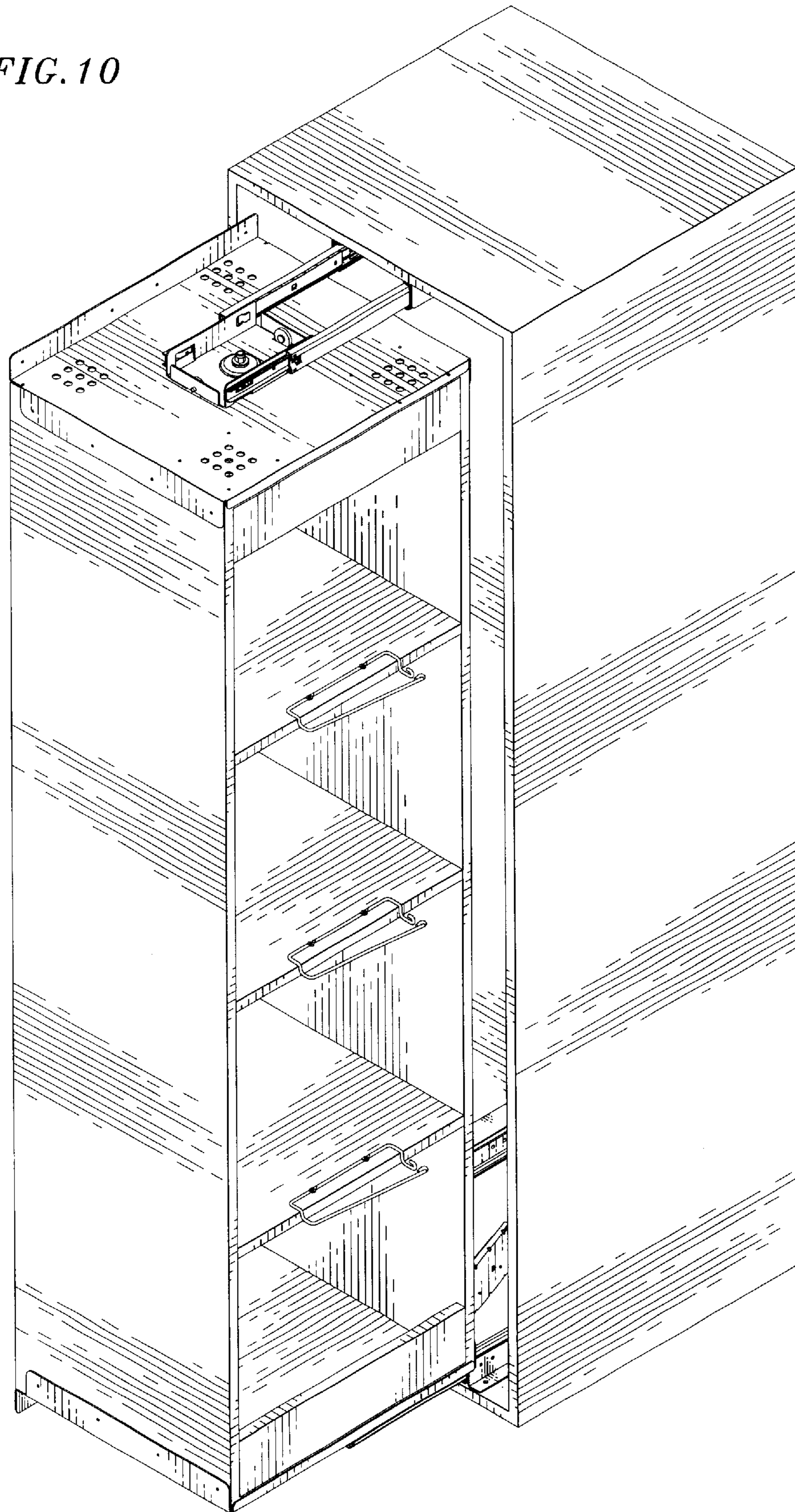

FIG. 11

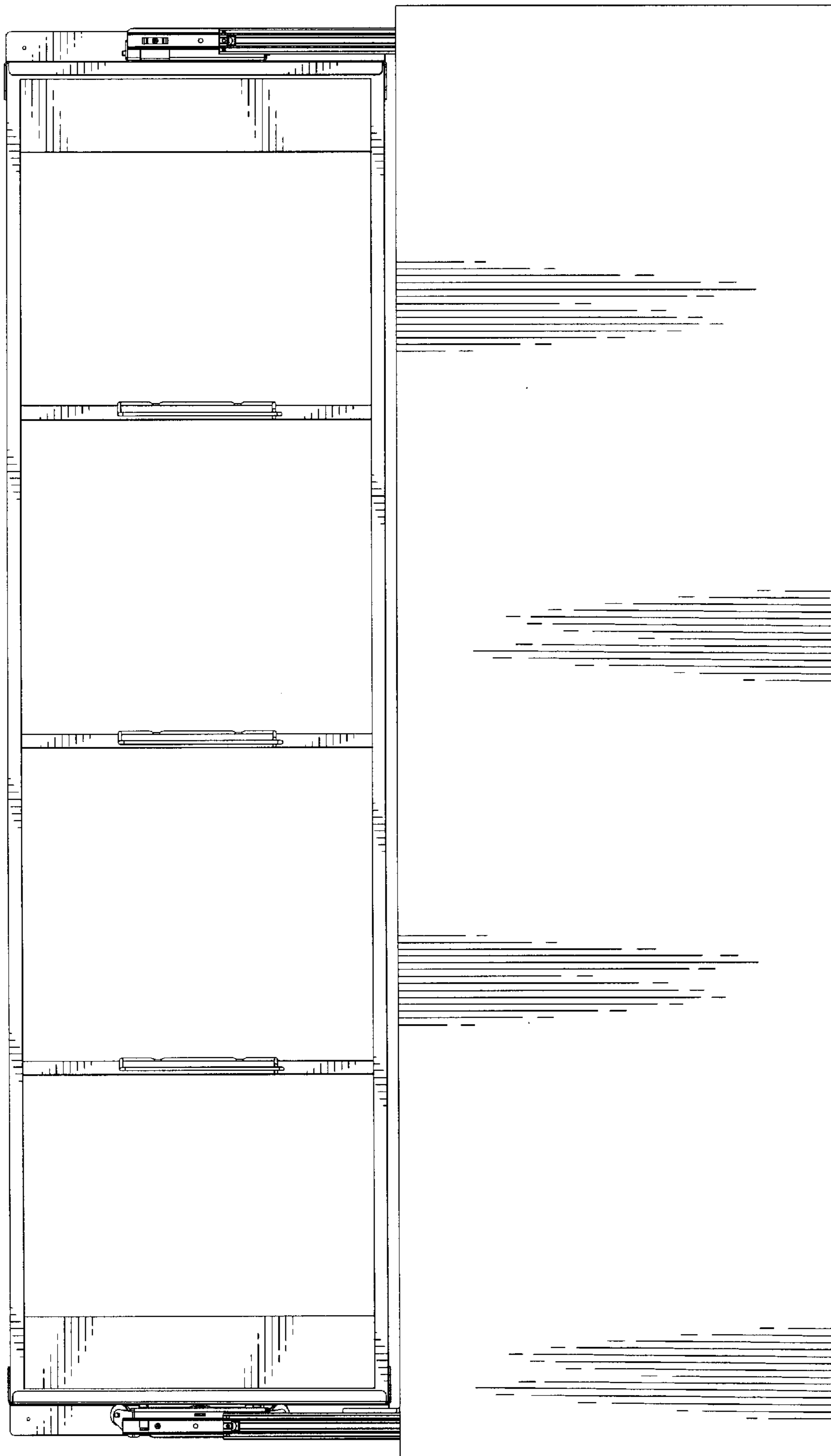

FIG. 12

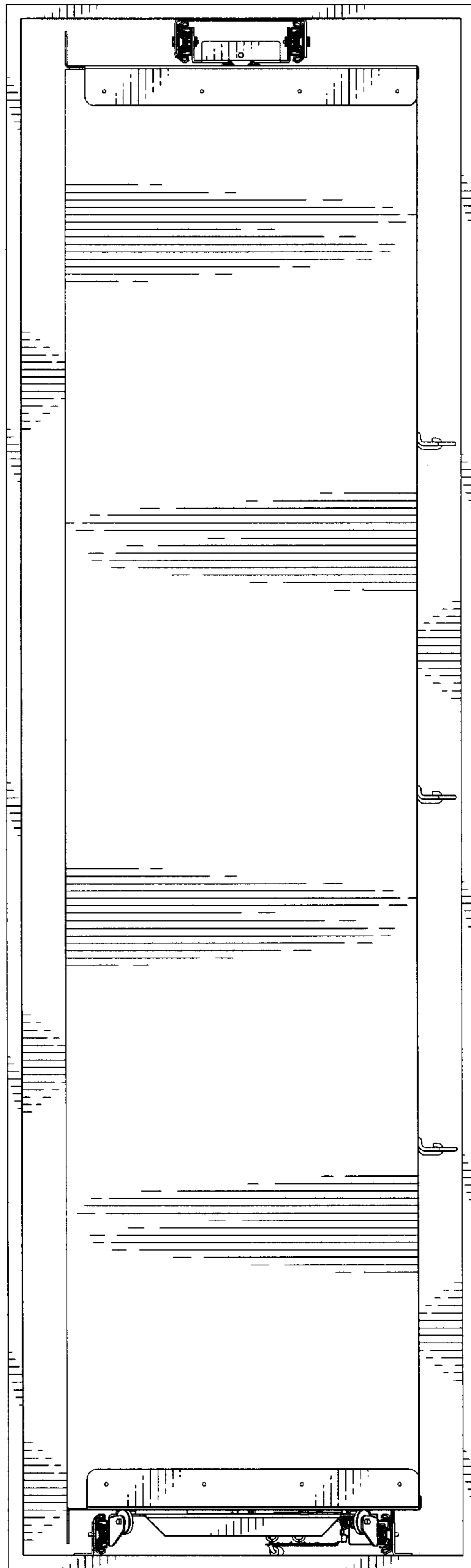

FIG. 13

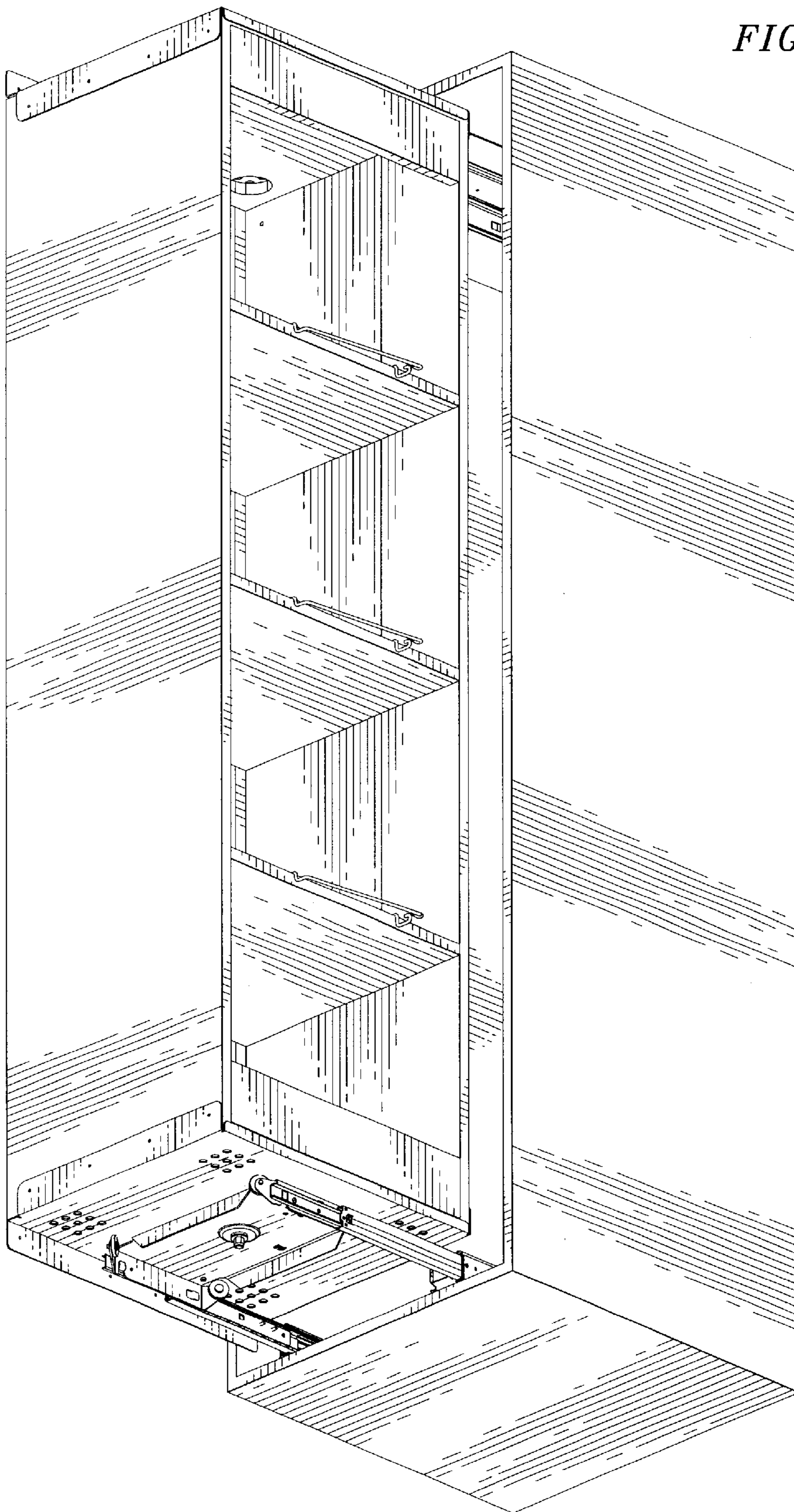

FIG. 14

