



US00D529989S

(12) **United States Design Patent**  
**Tse**

(10) **Patent No.:** **US D529,989 S**

(45) **Date of Patent:** **\*\* Oct. 10, 2006**

(54) **SPRAY HEAD FOR SHOWERS**

(76) Inventor: **Hing Fai Gary Tse**, 1908-1911, 19/F,  
Telford House, 16 Wang Hoi Road,  
Kowloon Bay, Kowloon, Hong Kong  
(CN)

(\*\*) Term: **14 Years**

(21) Appl. No.: **29/229,461**

(22) Filed: **May 9, 2005**

(51) **LOC (8) Cl.** ..... **23-01**

(52) **U.S. Cl.** ..... **D23/223**

(58) **Field of Classification Search** ..... D23/213,  
D23/223, 226; 239/394, 462  
See application file for complete search history.

(56) **References Cited**

**U.S. PATENT DOCUMENTS**

D424,160 S \* 5/2000 Haug et al. .... D23/223  
D424,162 S \* 5/2000 Haug et al. .... D23/223  
D431,278 S \* 9/2000 Tse ..... D23/223

D506,243 S \* 6/2005 Wu ..... D23/223  
D509,280 S \* 9/2005 Bailey et al. .... D23/223  
D509,563 S \* 9/2005 Bailey et al. .... D23/223

\* cited by examiner

*Primary Examiner*—Robin Webster

(57) **CLAIM**

The ornamental design for a spray head for showers, as shown.

**DESCRIPTION**

The claimed spray head for showers is used for releasing drops of water through the small holes.

FIG. 1 is a front elevational view of a spray head for showers showing my new design;

FIG. 2 is a rear elevational view thereof;

FIG. 3 is a left side view thereof;

FIG. 4 is a right side view thereof;

FIG. 5 is a top plan view thereof; and,

FIG. 6 is a bottom plan view thereof.

**1 Claim, 2 Drawing Sheets**

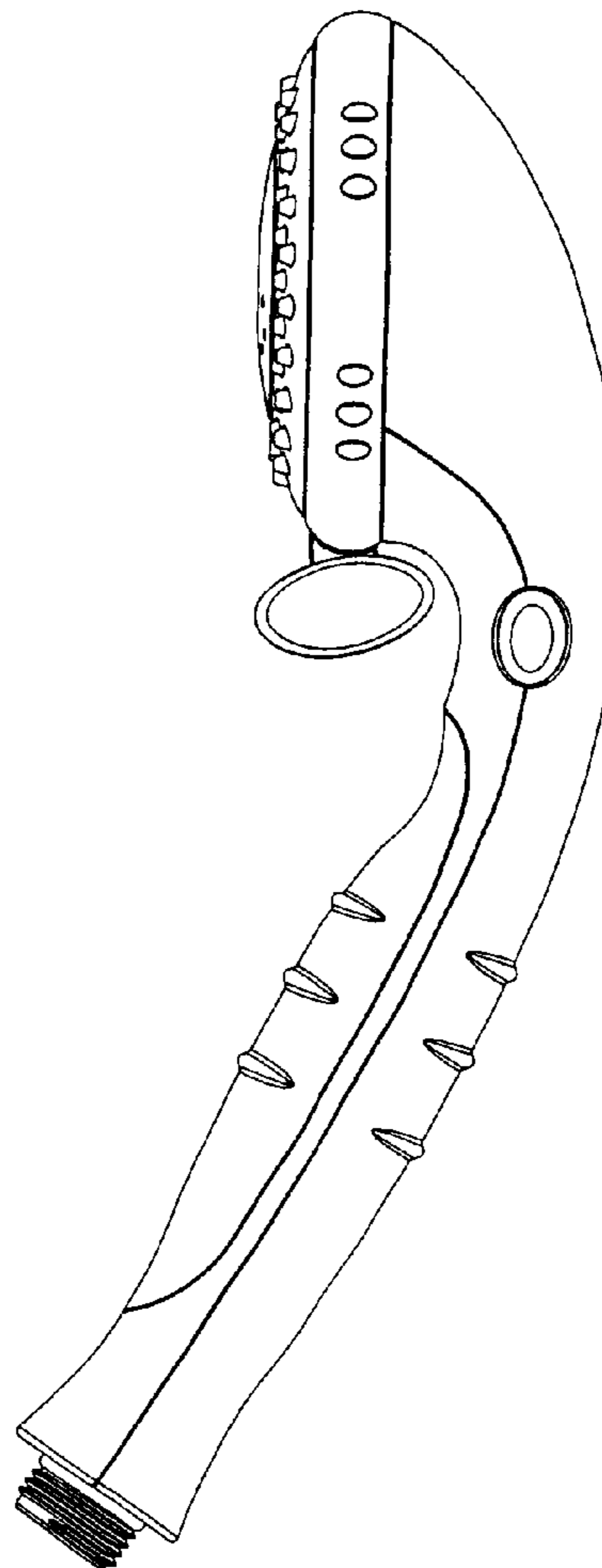
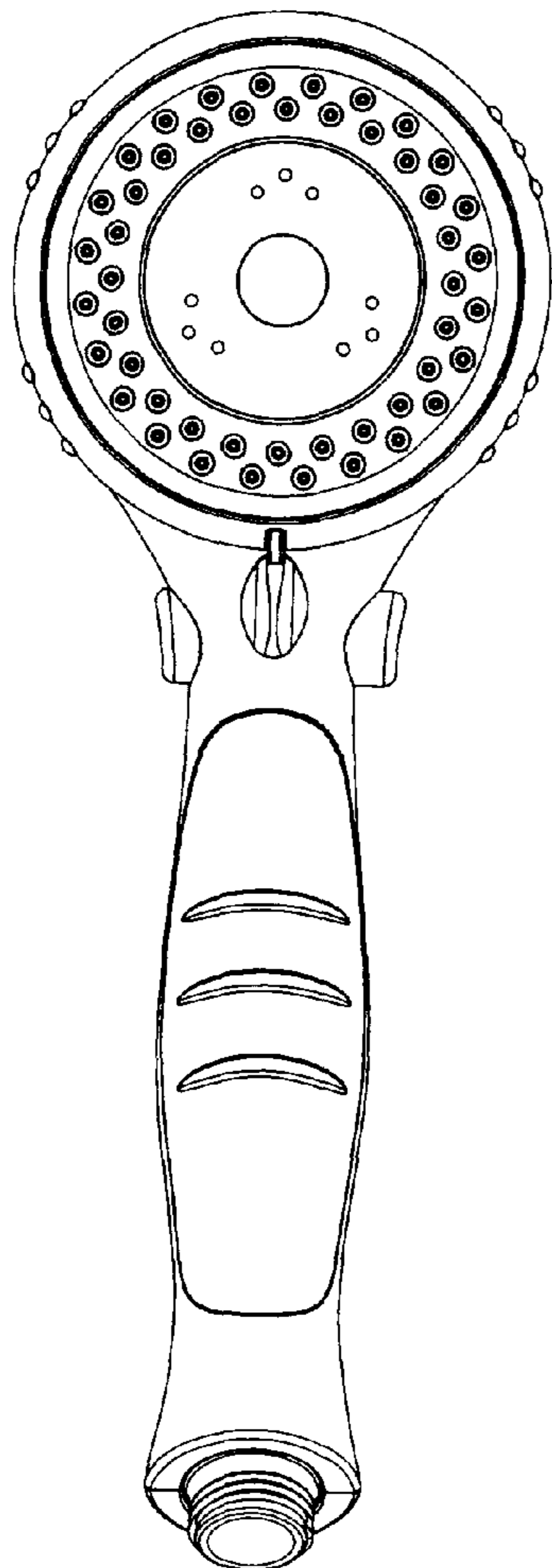

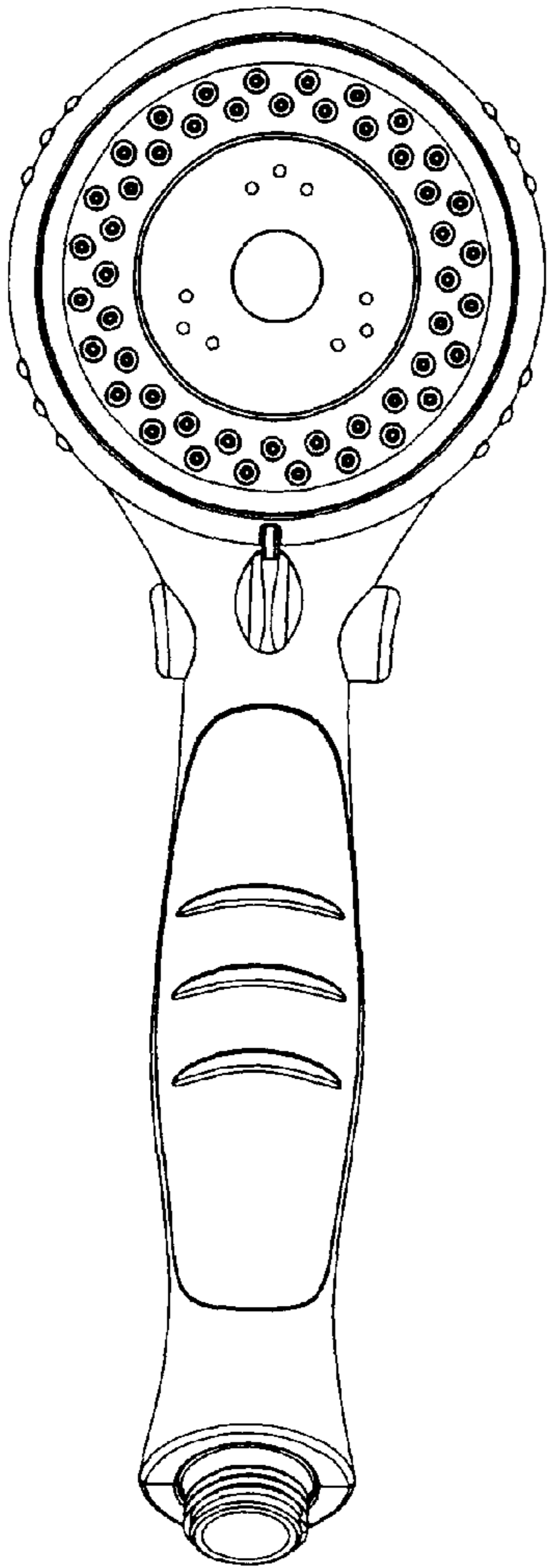

FIG. 1

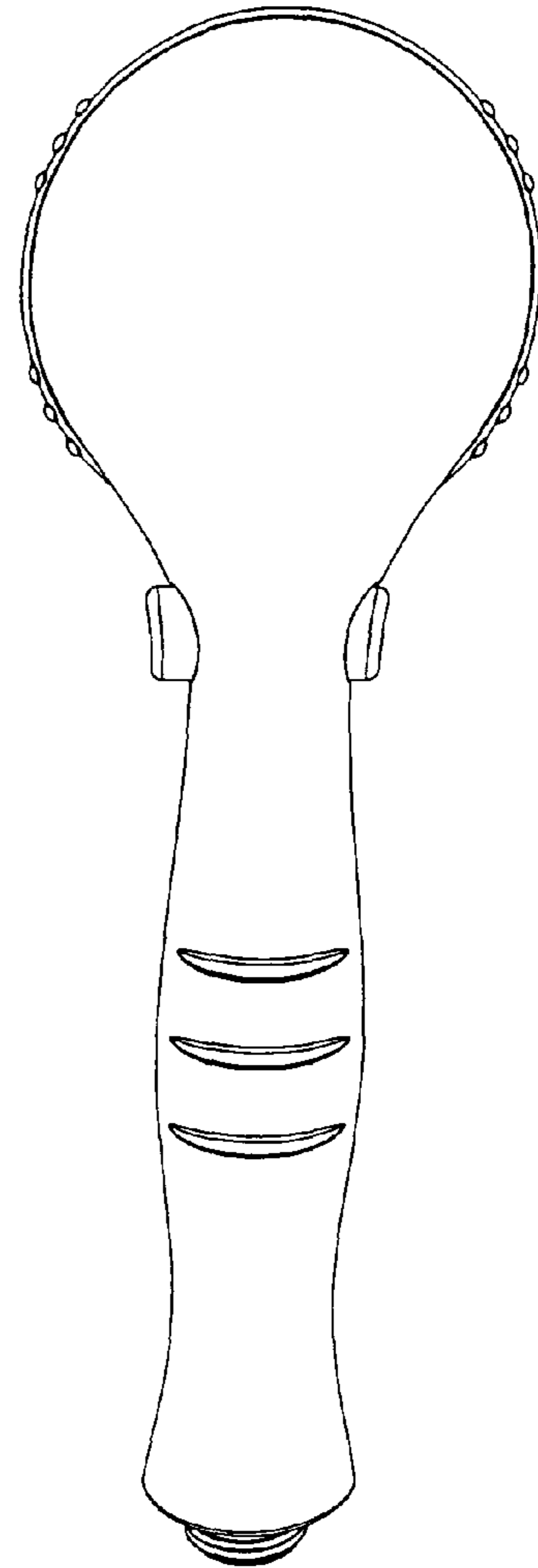

FIG. 2

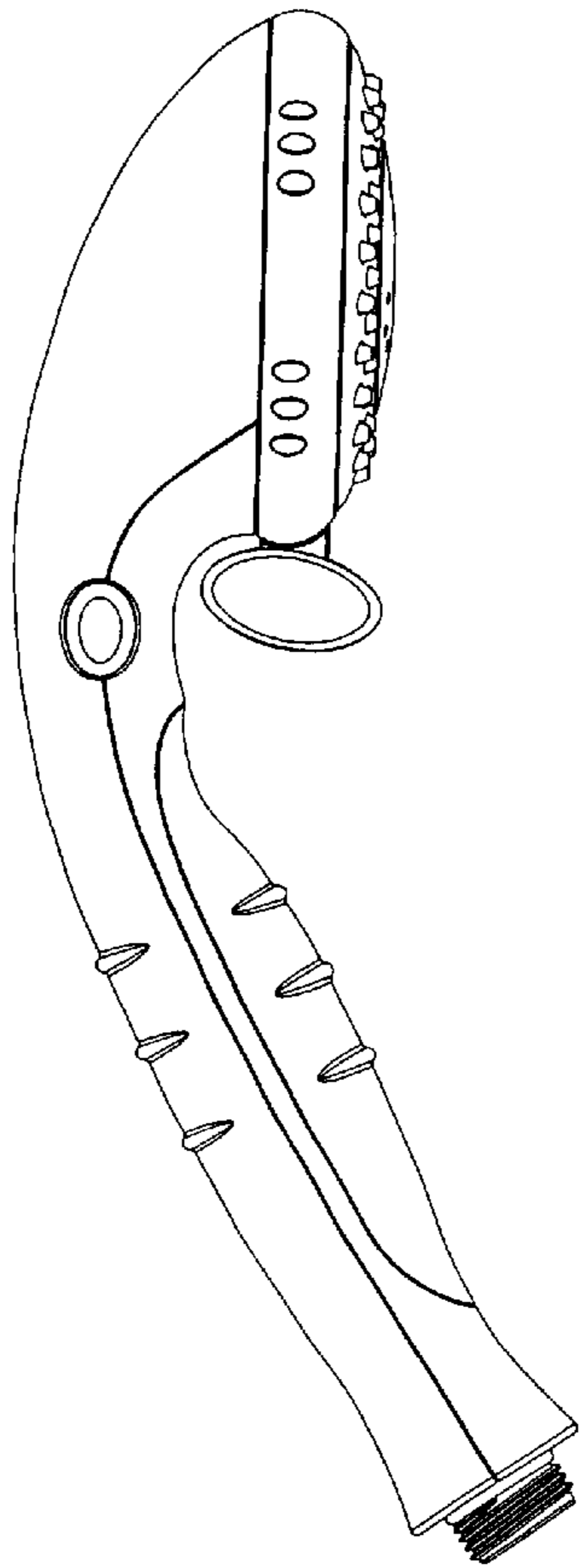

FIG. 3

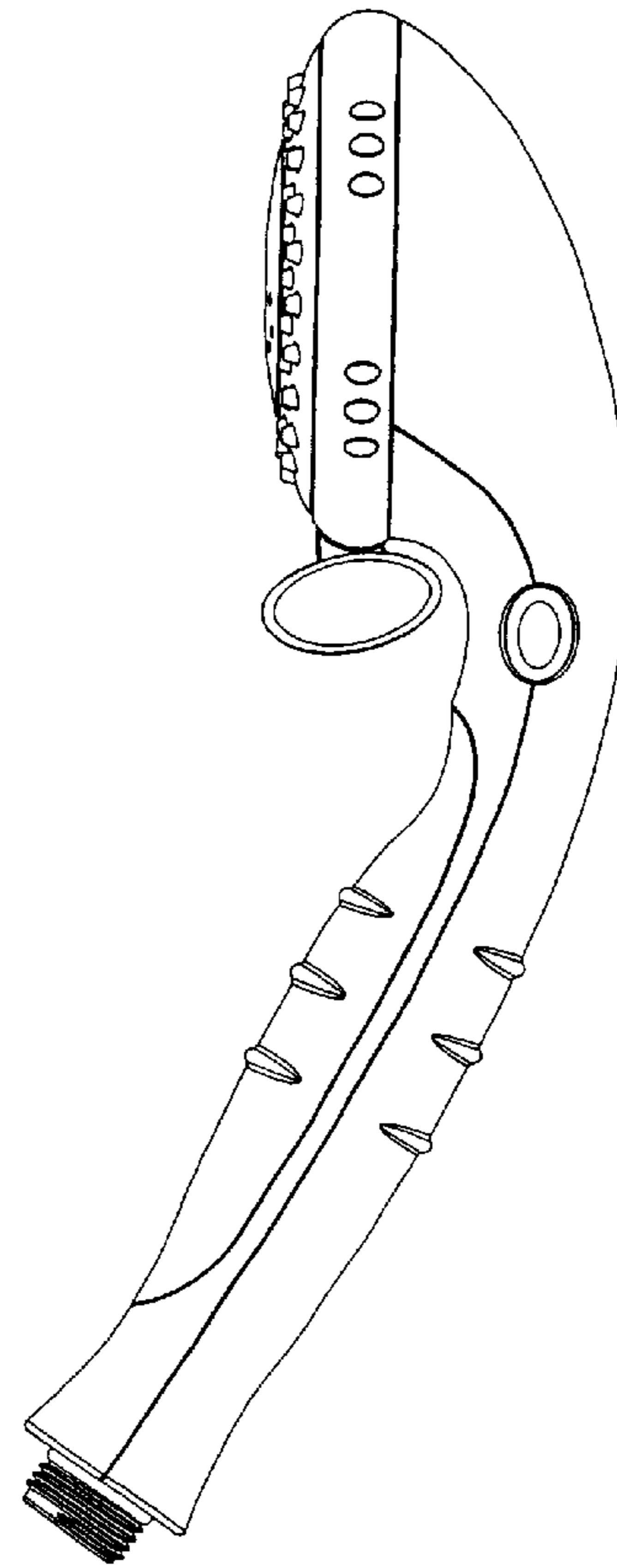

FIG. 4

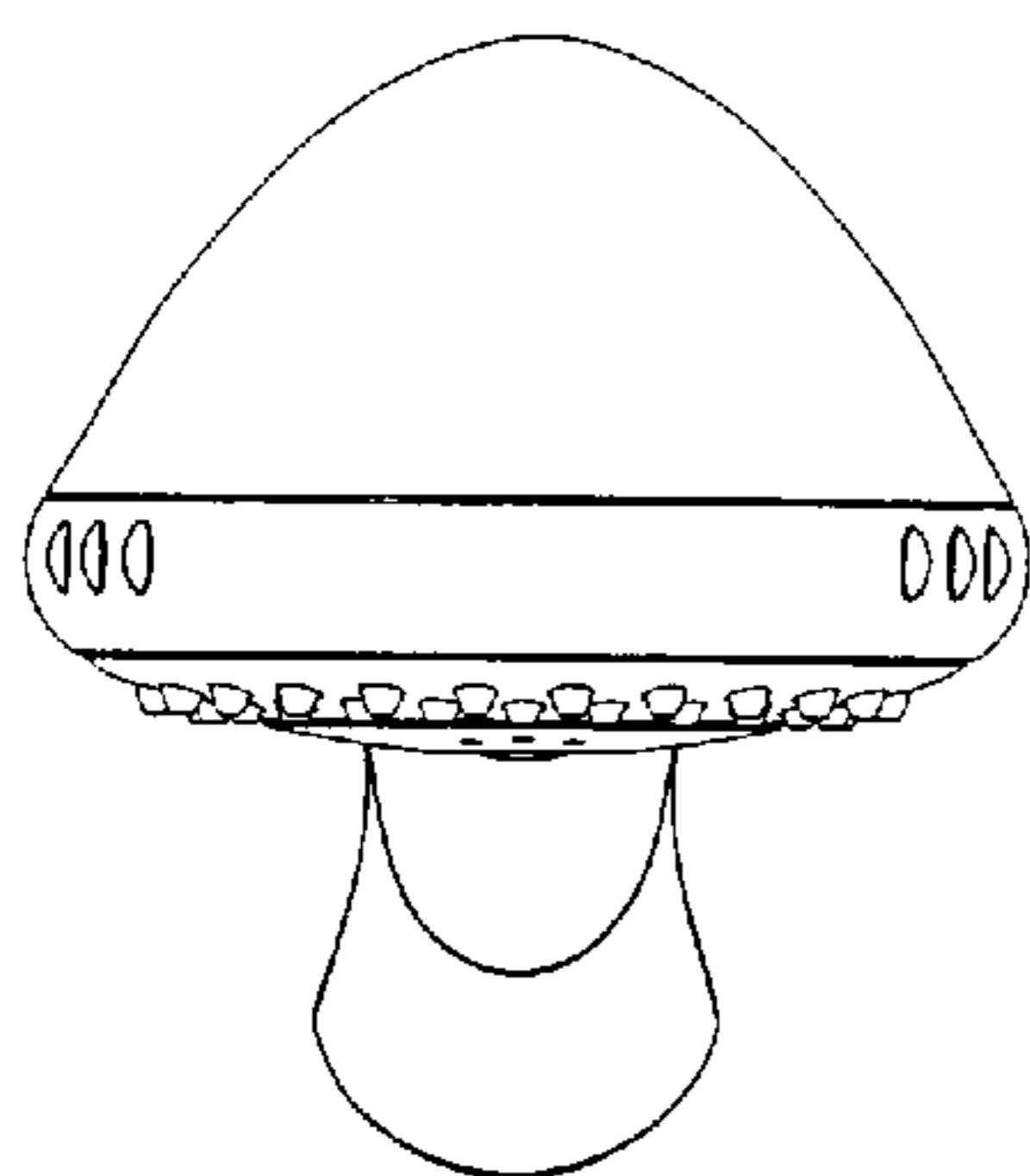

FIG. 5

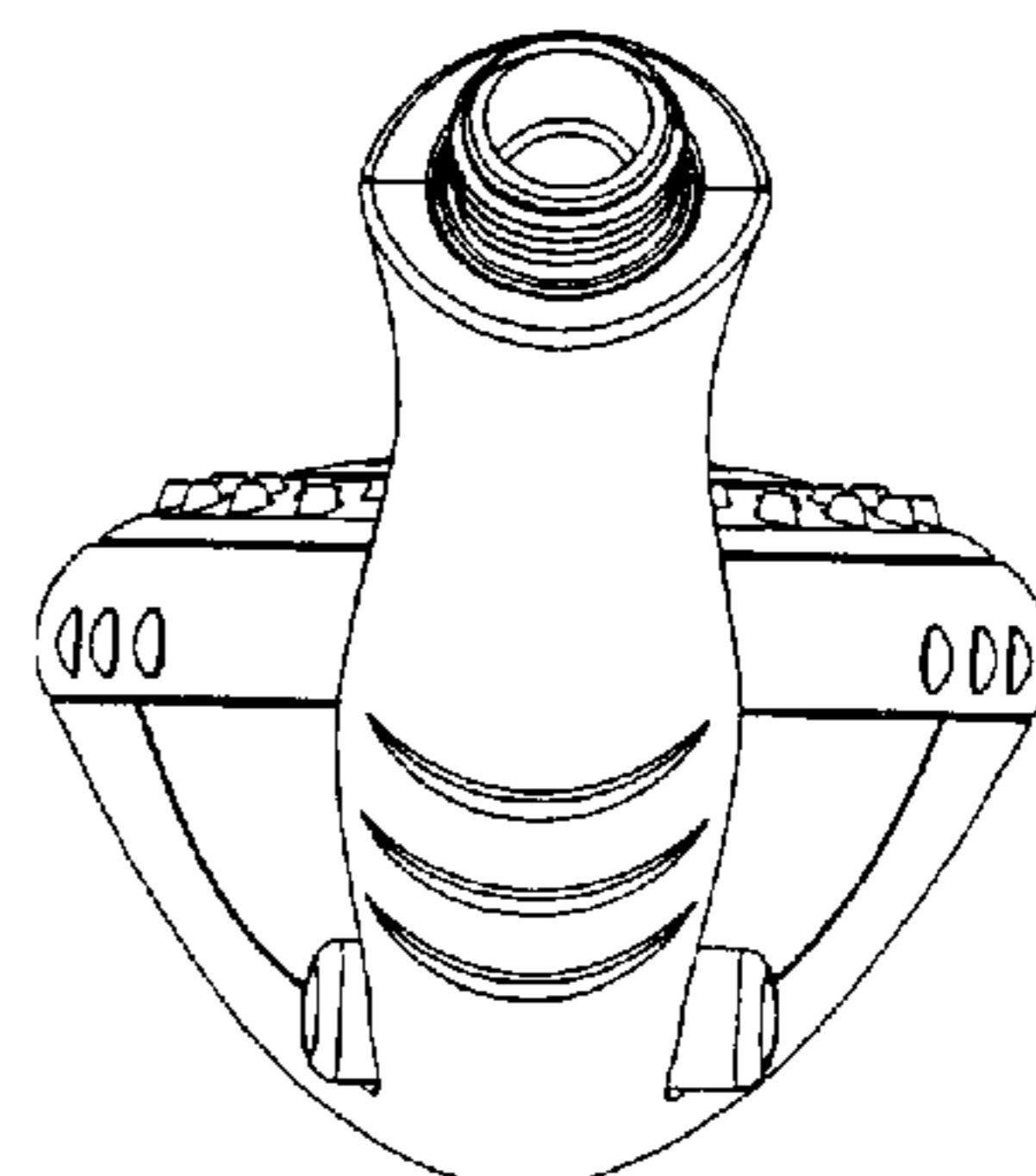

FIG. 6