



US00D529901S

(12) **United States Design Patent**
Ohta

(10) **Patent No.:** **US D529,901 S**
(45) **Date of Patent:** **** Oct. 10, 2006**

(54) **HEADPHONES**

(75) Inventor: **Jun Ohta**, Tokyo (JP)

(73) Assignee: **Kabushiki Kaisha Audio-Technica**,
Machida (JP)

(**) Term: **14 Years**

(21) Appl. No.: **29/240,685**

(22) Filed: **Oct. 18, 2005**

(30) **Foreign Application Priority Data**

Apr. 20, 2005 (JP) 2005-011730

(51) **LOC (8) Cl.** **14-01**

(52) **U.S. Cl.** **D14/223**

(58) **Field of Classification Search** D14/188,
D14/192, 205, 206, 223, 249; D24/174; 181/129,
181/130, 135, 137; 379/430; 381/381
See application file for complete search history.

(56) **References Cited**

U.S. PATENT DOCUMENTS

D431,553 S * 10/2000 Suzuki D14/223
D457,514 S * 5/2002 Marion et al. D14/223
D464,638 S * 10/2002 Huang D14/205
D474,171 S * 5/2003 Suzuki D14/206

D487,077 S * 2/2004 Obata D14/223
D519,108 S * 4/2006 Yang D14/223

* cited by examiner

Primary Examiner—Paula A. Greene

(74) *Attorney, Agent, or Firm*—Manabu Kanesaka

(57) **CLAIM**

The ornamental design for headphones, as shown and described.

DESCRIPTION

FIG. 1 is a perspective view of headphones showing my new design, a headphone is shown separately for purposes of illustration;

FIG. 2 is a front view thereof;

FIG. 3 is a rear view thereof;

FIG. 4 is a top plan view thereof;

FIG. 5 is a bottom view thereof;

FIG. 6 is a right side view thereof;

FIG. 7 is a left side view thereof; and,

FIG. 8 is a view taken along line I—I of FIG. 2 in the direction of arrowhead, a headphone is shown separately for purposes of illustration.

The broken lines are for illustrative purposes only and forms no part of the claimed design.

1 Claim, 6 Drawing Sheets

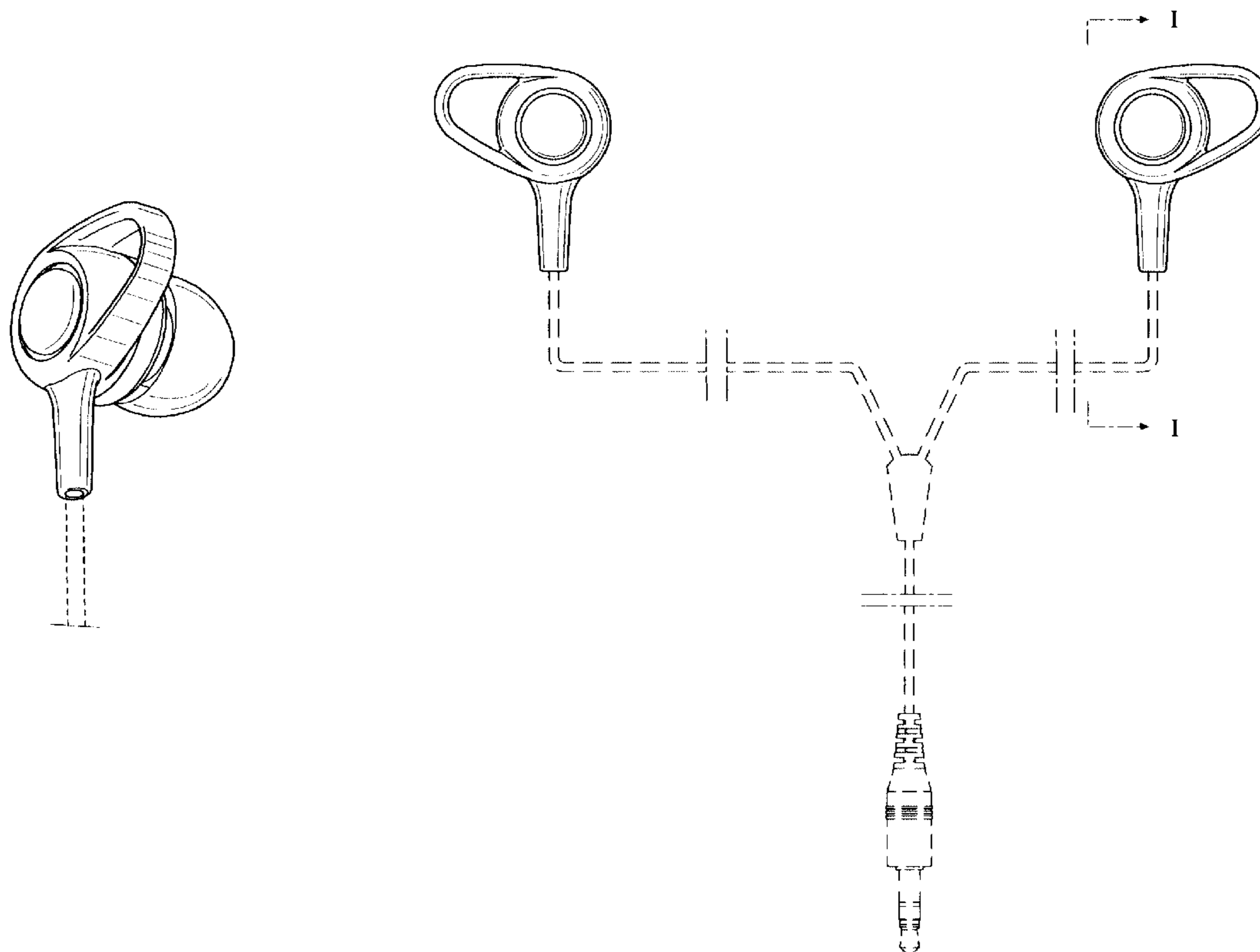

FIG. 1

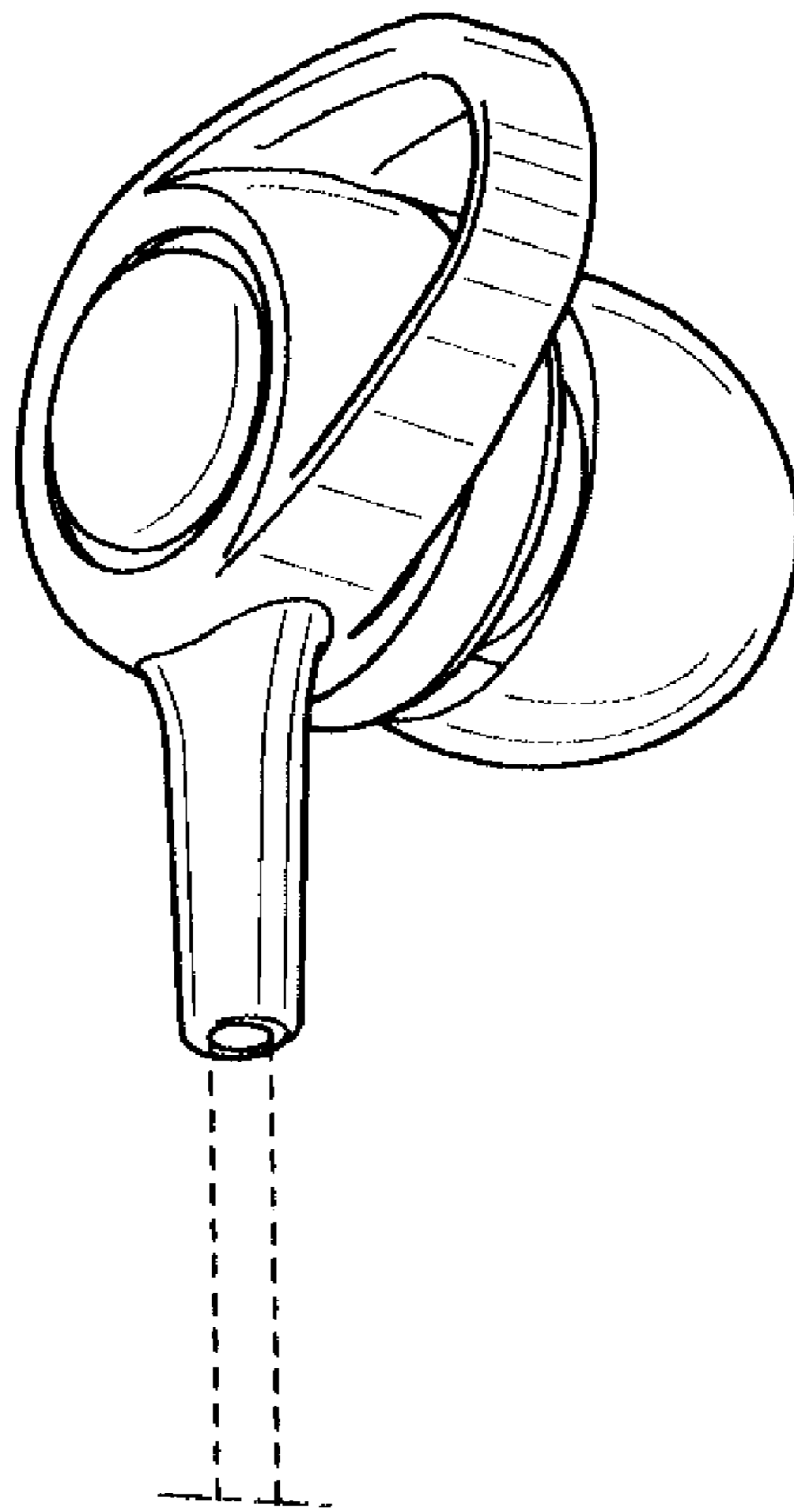

FIG.2

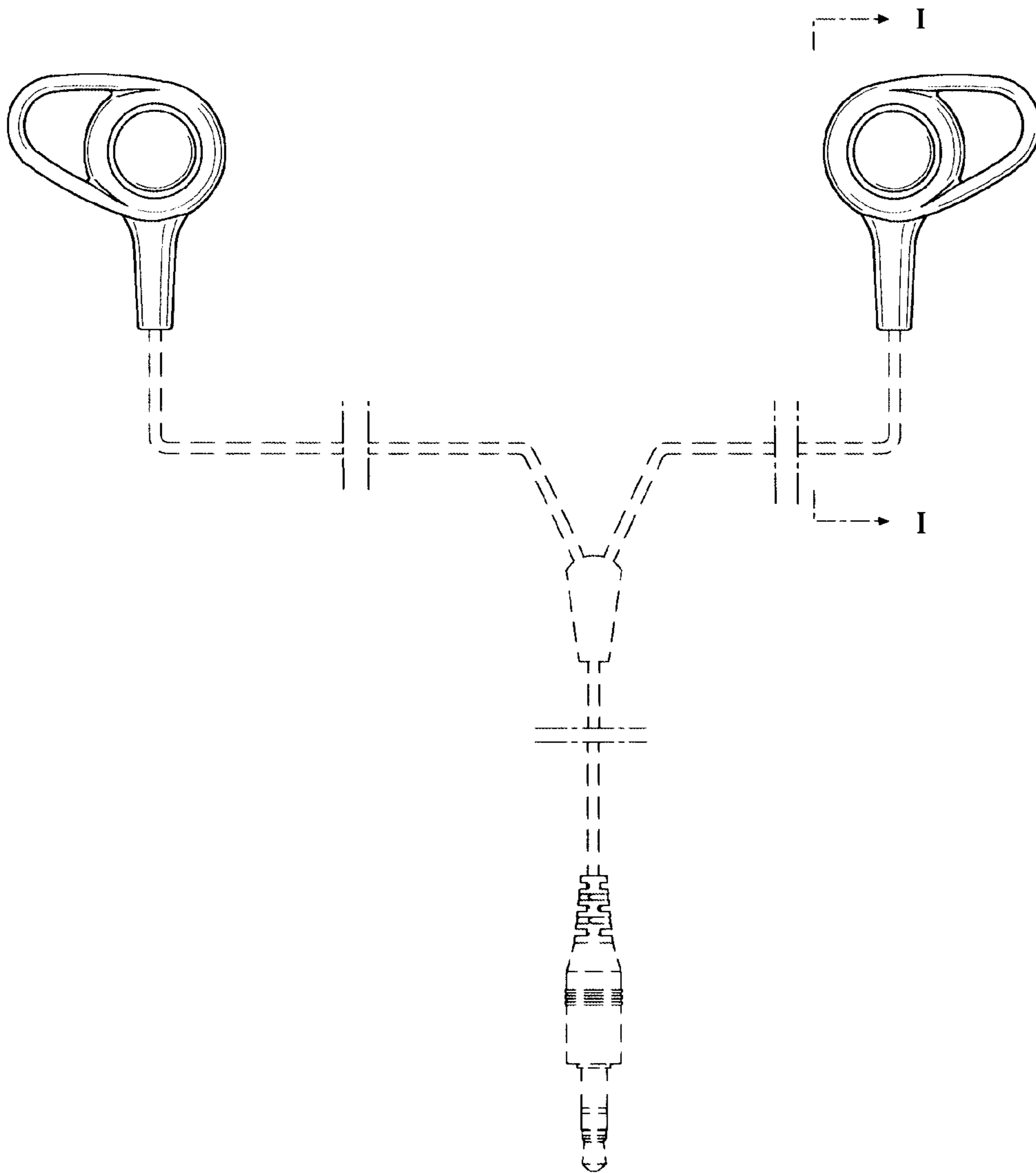

FIG.3

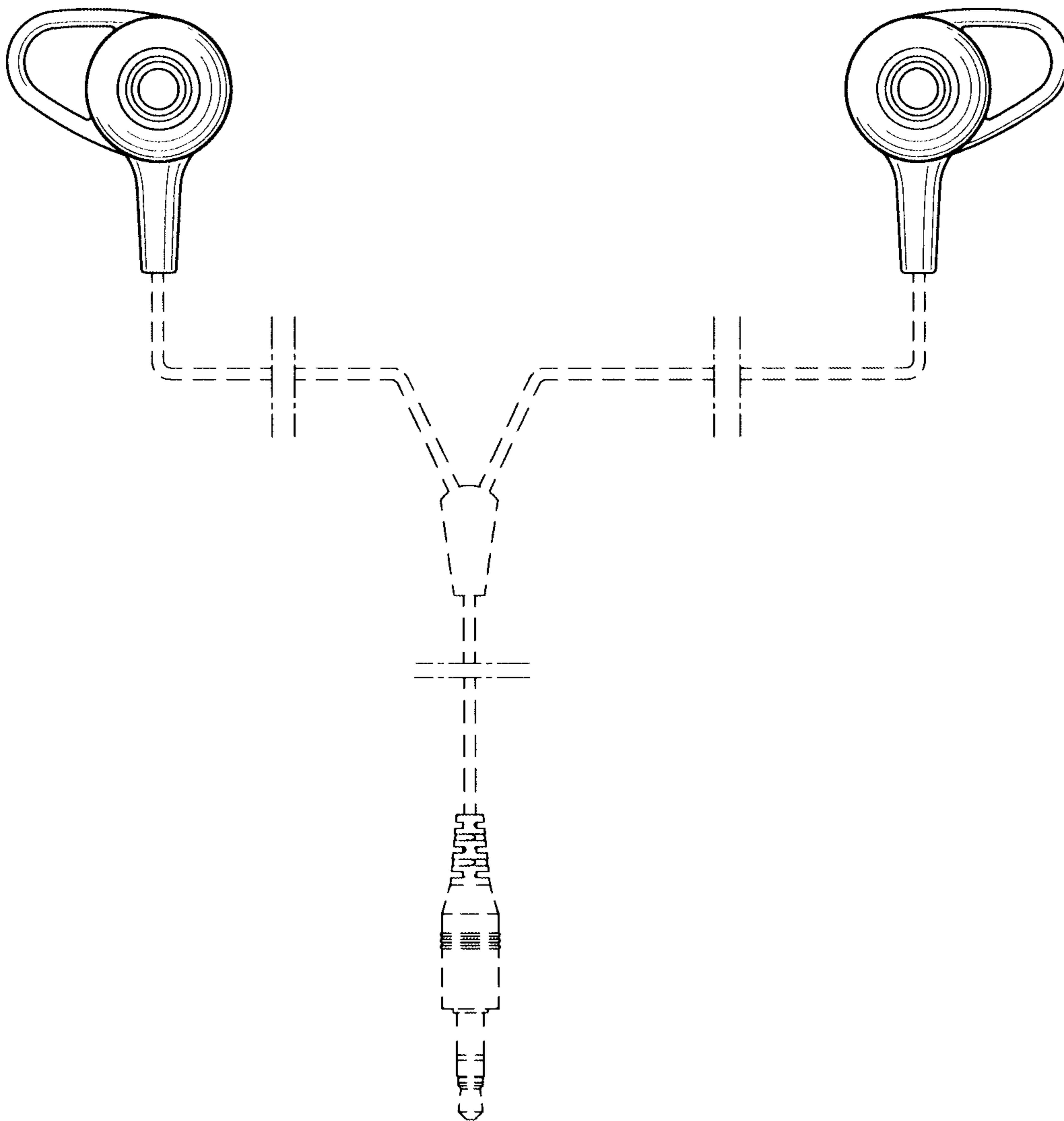

FIG.4

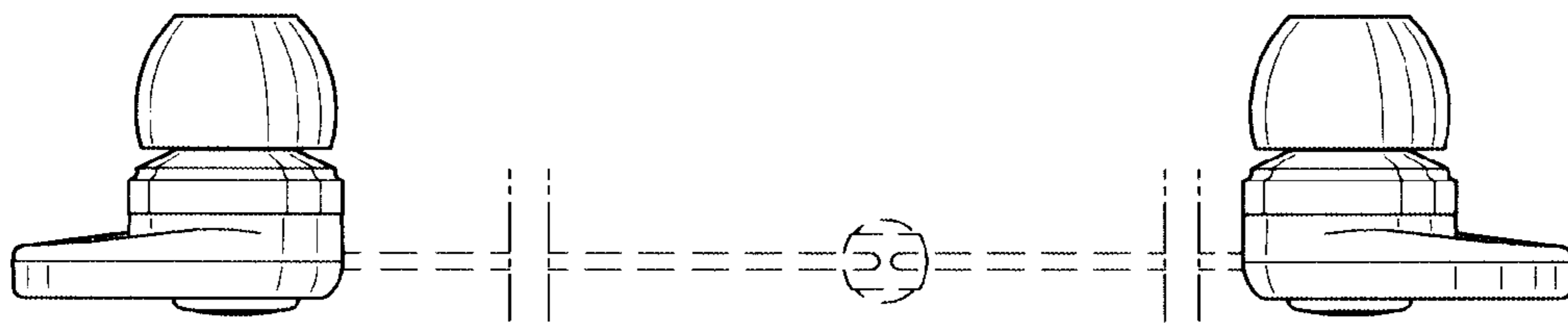

FIG.5

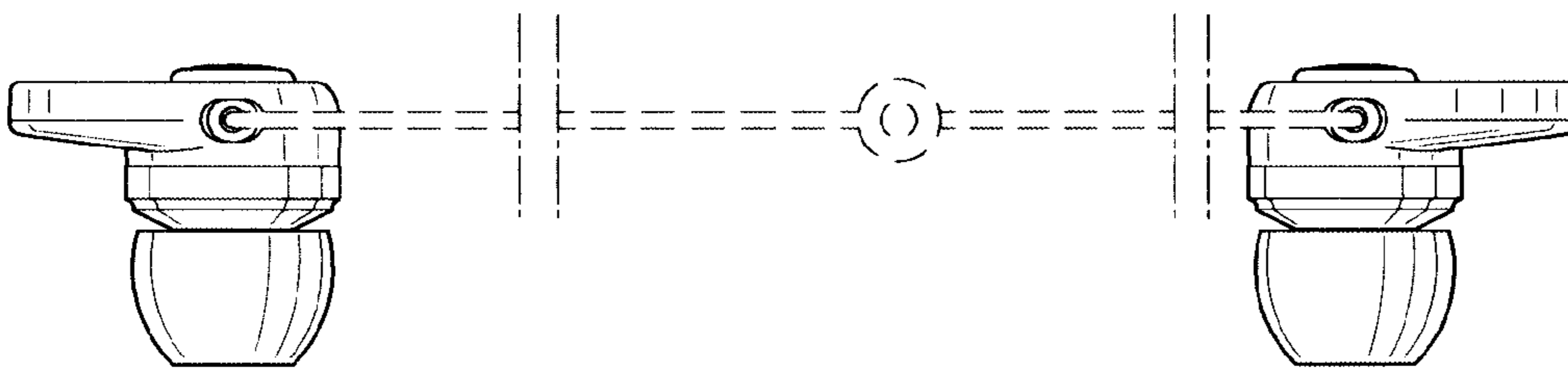

FIG.6

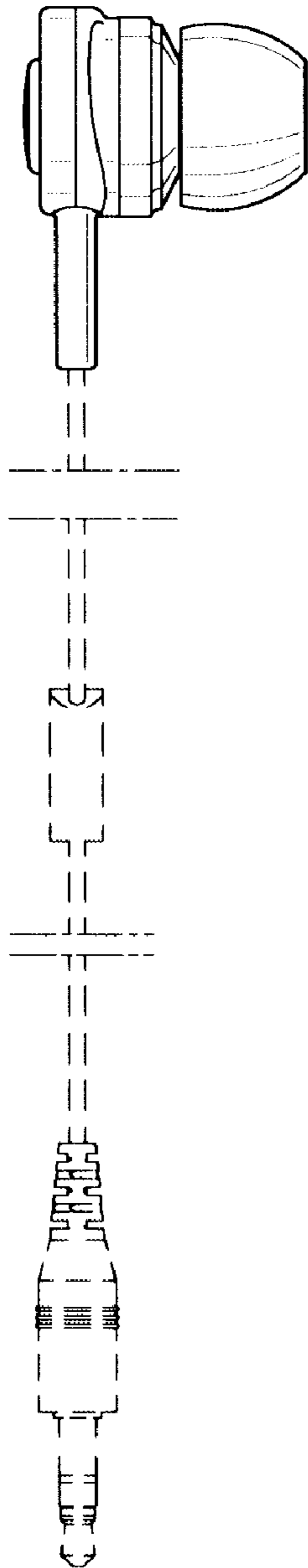

FIG.7

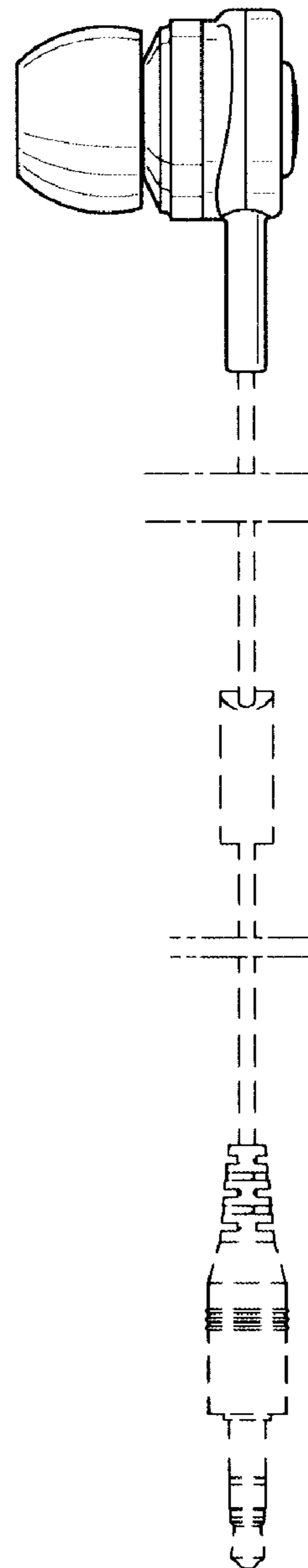

FIG.8

