

US00D529888S

(12) **United States Design Patent**
Lee et al.

(10) **Patent No.:** **US D529,888 S**
(45) **Date of Patent:** **** Oct. 10, 2006**

(54) **PORTABLE TELEPHONE**
(75) Inventors: **Ki-Eon Lee**, Seoul (KR); **Min-Hyok Lee**, Seoul (KR); **Chang-Hwan Hwang**, Seoul (KR)
(73) Assignee: **Samsung Electronics Co., Ltd.**, Suwon (KR)
(**) Term: **14 Years**

D481,692 S * 11/2003 Husgafvel D14/138
D484,862 S 1/2004 Yang
D484,863 S 1/2004 Chan
D485,249 S 1/2004 Liao et al.
D485,818 S 1/2004 Yabe et al.
D486,811 S 2/2004 Lheem
D487,443 S 3/2004 Yoon
D487,444 S 3/2004 Yoon
D488,453 S 4/2004 Chang et al.
D489,698 S 5/2004 Kim et al.
D489,699 S 5/2004 Hwang et al.
D490,389 S 5/2004 Yang
D491,906 S 6/2004 Okamatsu

(21) Appl. No.: **29/226,465**
(22) Filed: **Mar. 29, 2005**

(Continued)

(51) **LOC (8) Cl.** **14-03**
(52) **U.S. Cl.** **D14/138**
(58) **Field of Classification Search** D14/137,
D14/138, 147-148, 247-248, 144, 496, 156,
D14/341-347; 379/433.01-433.13; 455/575.4,
455/566, 575.1, 556.1, 556.2, 90.3; D21/329,
D21/331, 333; D16/208
See application file for complete search history.

FOREIGN PATENT DOCUMENTS

JP D1154363 9/2002

OTHER PUBLICATIONS

Samsung D410 telephone, announced fourth quarter 2003, [online], [retrieved on Mar. 30, 2006]. Retrieved from Internet ,URL: <http://www.gsmarena.com>>.*

(Continued)

(56) **References Cited**

U.S. PATENT DOCUMENTS

5,027,394 A 6/1991 Ono et al.
5,428,350 A 6/1995 Kurcbart et al.
5,436,954 A 7/1995 Nishiyama et al.
D407,716 S 4/1999 Park
D407,717 S 4/1999 Kim
D407,718 S 4/1999 Lee
D410,920 S 6/1999 Lee et al.
D411,537 S 6/1999 Lee
D414,765 S 10/1999 Park
D415,151 S 10/1999 Kim
D415,488 S 10/1999 Lee
6,069,648 A 5/2000 Suso et al.
D431,827 S 10/2000 Yim
D457,883 S * 5/2002 Sugioka et al. D14/342
6,389,267 B1 5/2002 Imai
6,396,924 B1 5/2002 Suso et al.
D458,594 S 6/2002 Jang
D469,367 S * 1/2003 Mirabelli et al. D10/65
D476,328 S * 6/2003 Miao et al. D14/346
D477,293 S 7/2003 Hwang

Primary Examiner—Jeffrey Asch
(74) *Attorney, Agent, or Firm*—Flynn, Thiel, Boutell & Tanis, P.C.

(57) **CLAIM**

The ornamental design for a portable telephone, as shown and described.

DESCRIPTION

FIG. 1. is a top front perspective view of a portable telephone showing our new design.
FIG. 2. is a front elevational view thereof.
FIG. 3. is a rear elevational view thereof.
FIG. 4. is a left side elevational view thereof.
FIG. 5. is a right side elevational view thereof.
FIG. 6. is a top plan view thereof; and,
FIG. 7. is a bottom plan view thereof.

1 Claim, 5 Drawing Sheets

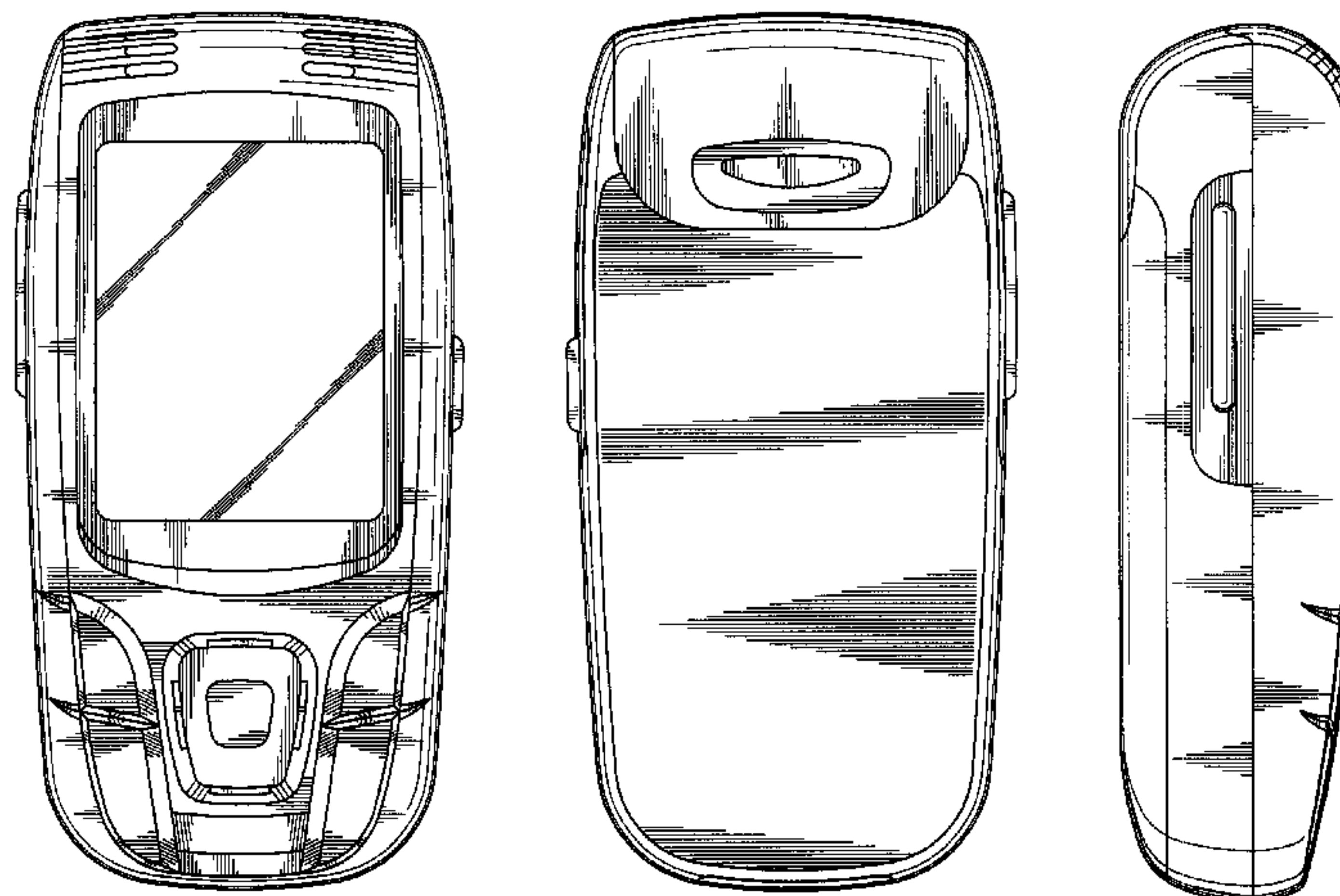

U.S. PATENT DOCUMENTS

D491,907	S	6/2004	Ogawa	
D493,439	S	7/2004	Hong et al.	
D493,440	S	7/2004	Chou et al.	
D494,151	S *	8/2004	Walliser et al.	D14/138
D495,672	S	9/2004	Jeon et al.	
D495,674	S	9/2004	Yoo et al.	
D496,020	S	9/2004	Lee	
D496,021	S	9/2004	Jang	
6,822,871	B1 *	11/2004	Lee et al.	361/737
D500,992	S *	1/2005	Shen et al.	D14/138
D500,993	S	1/2005	Hwang	
D501,458	S	2/2005	Kim et al.	
D501,658	S	2/2005	Park et al.	
D501,837	S	2/2005	Kim et al.	
D501,838	S	2/2005	Kim et al.	
D502,161	S	2/2005	Kim et al.	
D502,162	S *	2/2005	Kim et al.	D14/138
D502,454	S *	3/2005	Lee	D14/138
D503,164	S	3/2005	Park et al.	
D503,171	S *	3/2005	Park et al.	D14/346
D503,699	S *	4/2005	Lee et al.	D14/138
D504,406	S	4/2005	Cho et al.	
D506,454	S	6/2005	Kim et al.	
D506,738	S	6/2005	Kim et al.	
D506,988	S *	7/2005	Oh	D14/138
D507,252	S	7/2005	Kim et al.	
D508,240	S *	8/2005	Lee et al.	D14/138
D508,473	S *	8/2005	Lee et al.	D14/138
D508,687	S *	8/2005	Lee	D14/138
D508,688	S *	8/2005	Lee et al.	D14/138
D509,202	S *	9/2005	Lee et al.	D14/138
D509,497	S *	9/2005	Michler	D14/138
D509,814	S *	9/2005	Shin et al.	D14/138
D512,393	S *	12/2005	Lee et al.	D14/138
D512,702	S *	12/2005	Lee et al.	D14/138
2001/0036845	A1	11/2001	Park	
2002/0187818	A1	12/2002	Kang	
2003/0064688	A1 *	4/2003	Mizuta et al.	455/90
2003/0109232	A1	6/2003	Park et al.	
2004/0009790	A1	1/2004	Im	
2004/0023684	A1	2/2004	Sato et al.	
2004/0097258	A1	5/2004	Lee et al.	
2004/0097262	A1	5/2004	Lee	
2004/0132513	A1	7/2004	Taneda et al.	
2004/0142718	A1	7/2004	Kim	
2004/0142734	A1	7/2004	Kim	
2005/0009581	A1 *	1/2005	Im et al.	455/575.4
2005/0083642	A1 *	4/2005	Senpuku et al.	361/681
2005/0107126	A1 *	5/2005	Kim	455/565
2005/0124394	A1 *	6/2005	Kim et al.	455/575.3
2005/0190291	A1 *	9/2005	Kota et al.	348/376
2005/0202856	A1 *	9/2005	Park et al.	455/575.1
2005/0250532	A1 *	11/2005	Hwang et al.	455/550.1

OTHER PUBLICATIONS

Samsung E850 telephone, announced fourth quarter 2004, [online], [retrieved on Feb. 14, 2006]. Retrieved from Internet ,URL: <http://www.gsmarena.com>>.*

Sagem myZ-5 telephone, announced Feb. 2006, [online], [retrieved on Mar. 30, 2006]. Retrieved from Internet ,URL: <http://www.gsmarena.com>>.*

LG A7150 telephone, announced fourth quarter 2004, [online], [retrieved on Mar. 30, 2006]. Retrieved from Internet ,URL: <http://www.gsmarena.com>>.*

Sagem MY Z-55 telephone, announced 1st quarter 2005, [online], [retrieved on Mar. 3, 2006]. Retrieved from Internet ,URL: <http://www.gsmarena.com>>.*

Samsung E810 telephone, announced Mar. 2004, [online], [retrieved on Mar. 30, 2006]. Retrieved from Internet ,URL: <http://www.gsmarena.com>>.*

Samsung D428 telephone, announced fourth quarter 2004, [online], [retrieved on Mar. 30, 2006]. Retrieved from Internet ,URL: <http://www.gsmarena.com>>.*

VK Mobile VK900 telephone, announced fourth quarter 2004, [online], [retrieved on Mar. 1, 2006]. Retrieved from Internet ,URL: <http://www.gsmarena.com>>.*

U.S. Appl. No. 29/204,878, Applicant: Bum-Soo Park, et al., filed May 5, 2004 entitled Portable Telephone.

U.S. Appl. No. 29/204,882, Applicant: Jin-Soo Kim, et al., filed May 5, 2004 entitled Portable Telephone.

U.S. Appl. No. 29/204,874, Applicant: Jin-Soo Kim, et al., filed May 5, 2004 entitled Portable Telephone.

U.S. Appl. No. 29/204,875, Applicant: Jin-Soo Kim, et al., filed May 5, 2004 entitled Portable Telephone.

U.S. Appl. No. 29/204,883, Applicant: Jin-Soo Kim, et al., filed May 5, 2004 entitled Portable Telephone.

U.S. Appl. No. 29/205,555, Applicant: Chi-Young Ahn, et al., filed May 17, 2004 entitled Portable Telephone.

U.S. Appl. No. 29/205,559, Applicant: Chi-Young Ahn, et al., filed May 17, 2004 entitled Portable Telephone.

U.S. Appl. No. 29/205,546, Applicant: Chi-Young Ahn, et al., filed May 17, 2004 entitled Portable Telephone.

U.S. Appl. No. 29/214,253, Applicant: Hye-Jeong Lee, et al., filed Sep. 27, 2004 entitled Portable Telephone.

U.S. Appl. No. 29/216,563, Applicant: Jin-Soo Kim, et al., filed Nov. 4, 2004 entitled Portable Telephone.

U.S. Appl. No. 29/226,417, Applicant: Jin-Soo Kim, et al., filed Mar. 29, 2005 entitled Portable Telephone.

U.S. Appl. No. 29/226,418, Applicant: Ji-Hyun Moon, et al., filed Mar. 29, 2005 entitled Portable Telephone.

U.S. Appl. No. 29/226,419, Applicant: Min-Ah Koh, et al., filed Mar. 29, 2005 entitled Portable Telephone.

U.S. Appl. No. 29/226,420, Applicant: Min-Hyouk Lee, et al., filed Mar. 29, 2005 entitled Portable Telephone.

U.S. Appl. No. 29/226,442, Applicant: Min-Hyouk Lee, et al., filed Mar. 29, 2005 entitled Portable Telephone.

U.S. Appl. No. 29/226,443, Applicant: Jin-Soo Kim, et al., filed Mar. 29, 2005 entitled Portable Telephone.

U.S. Appl. No. 29/226,470, Applicant: Nam-Su Kim, et al., filed Mar. 29, 2005 entitled Portable Telephone.

U.S. Appl. No. 29/226,474, Applicant: Nam-Su Kim, et al., filed Mar. 29, 2005 entitled Portable Telephone.

U.S. Appl. No. 29/226,460, Applicant: Nam-Su Kim, et al., filed Mar. 29, 2005 entitled Portable Telephone.

U.S. Appl. No. 29/226,461, Applicant: Joon-Ki Yun, et al., filed Mar. 29, 2005 entitled Portable Telephone.

U.S. Appl. No. 29/226,462, Applicant: Yu-Guen Kim, et al., filed Mar. 29, 2005 entitled Portable Telephone.

U.S. Appl. No. 29/226,463, Applicant: Jin-Soo Kim, et al., filed Mar. 29, 2005 entitled Portable Telephone.

U.S. Appl. No. 29/226,464, Applicant: Joon-Ki Yun, et al., filed Mar. 29, 2005 entitled Portable Telephone.

U.S. Appl. No. 29/226,454, Applicant: Woo-Seung Han, et al., filed Mar. 29, 2005 entitled Portable Telephone.

U.S. Appl. No. 29/226,455, Applicant: Woo-Seung Han, et al., filed Mar. 29, 2005 entitled Portable Telephone.

U.S. Appl. No. 29/226,982, Applicant: Yu-Guen Kim, et al., filed Apr. 5, 2005 entitled Portable Telephone.

U.S. Appl. No. 29/226,990, Applicant: Yu-Guen Kim, et al., filed Apr. 5, 2005 entitled Portable Telephone.

U.S. Appl. No. 29/227,339, Applicant: Joon-Suh Kim, et al.,
filed Apr. 7, 2005 entitled Portable Telephone.

U.S. Appl. No. 29/227,338, Applicant: Joon-Suh Kim, et al.,
filed Apr. 7, 2005 entitled Portable Telephone.

U.S. Appl. No. 29/227,258, Applicant: Min-Ah Koh, et al.,
filed Apr. 8, 2005 entitled Portable Telephone.

U.S. Appl. No. 29/219,068, Applicant: Dae-Yoeb Park, et
al., filed Dec. 10, 2004 entitled Portable Telephone.

U.S. Appl. No. 29/247,584, Applicant: Ha-Youl Jung, et al.,
filed Mar. 3, 2005 entitled Portable Telephone.

* cited by examiner

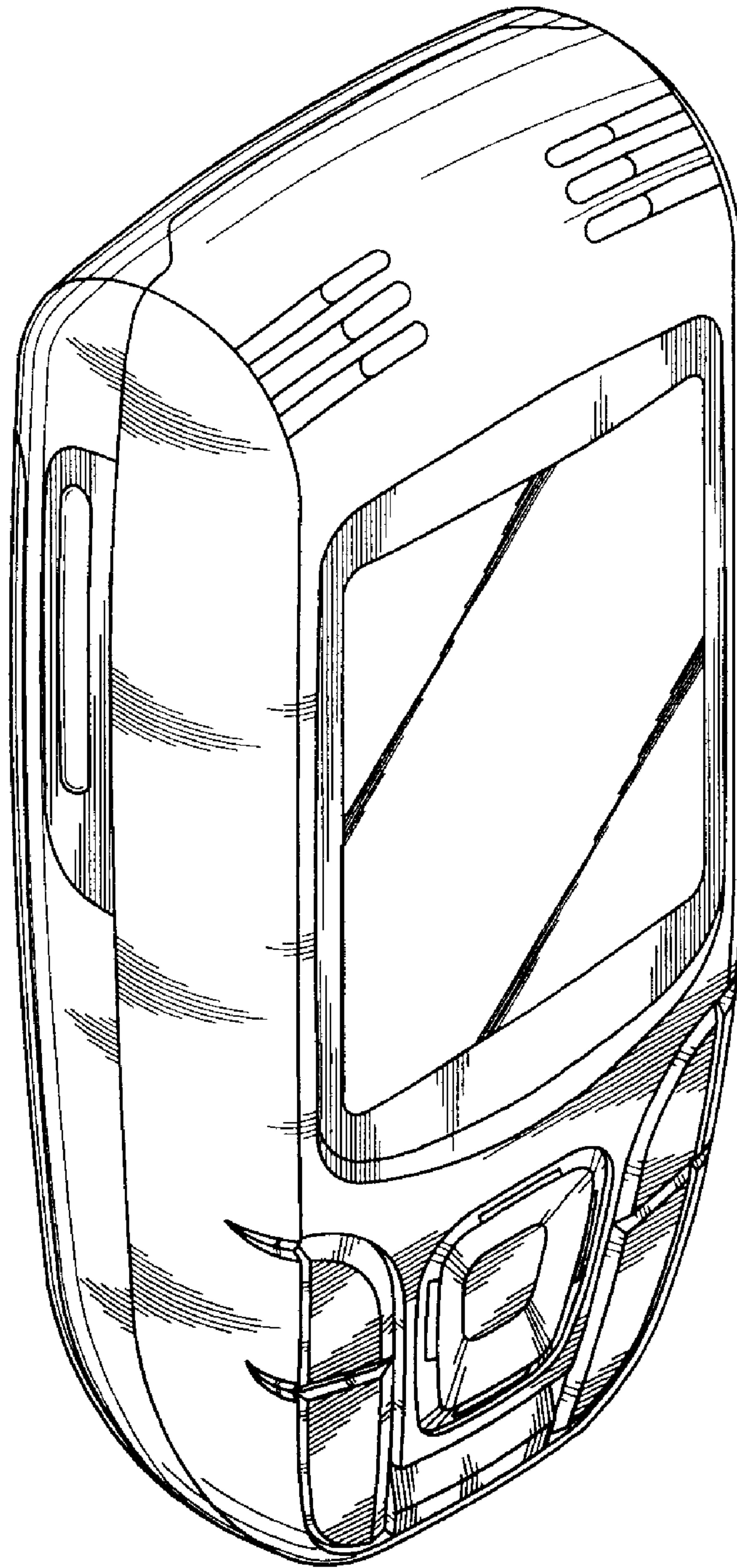

FIG. 1

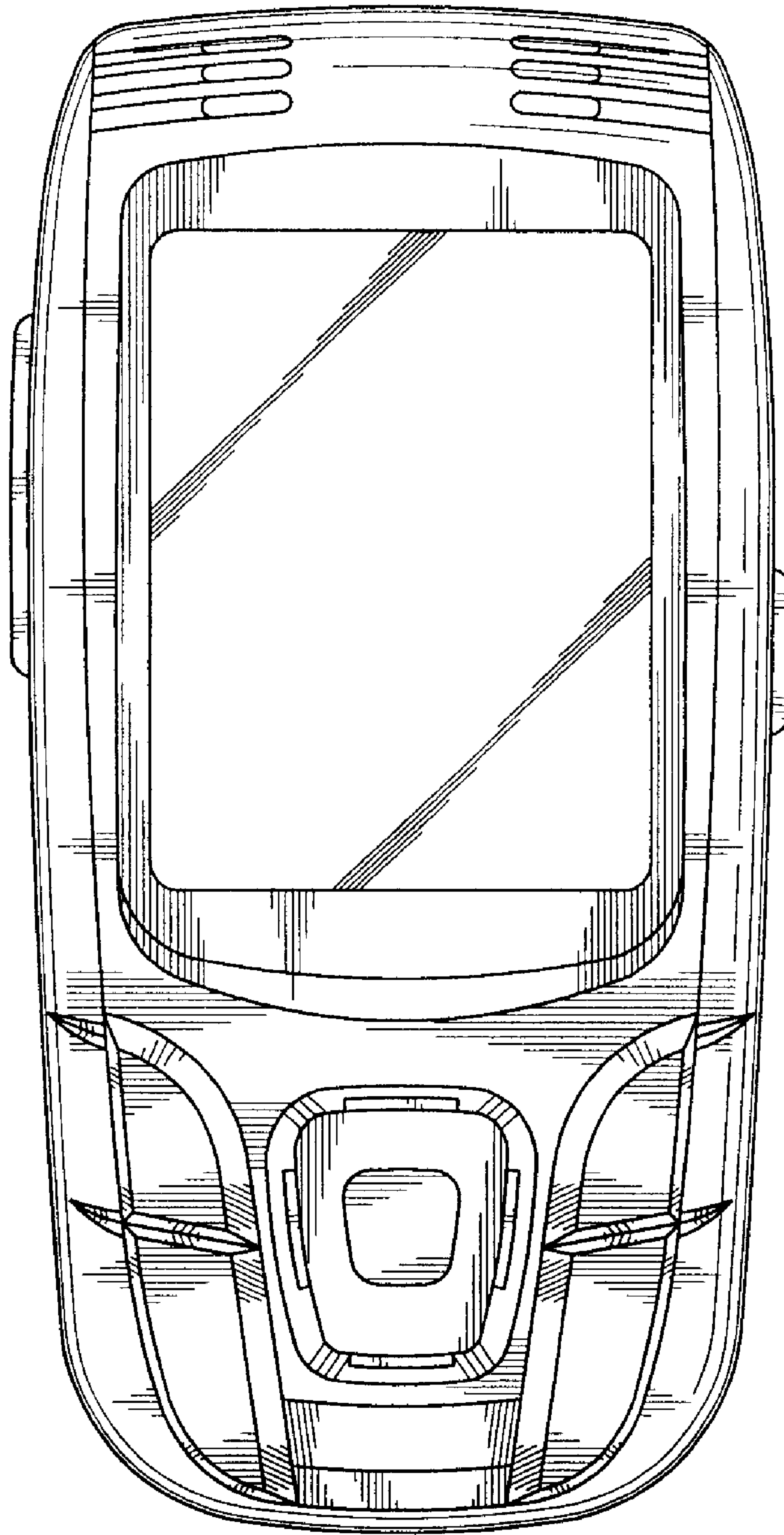

FIG. 2

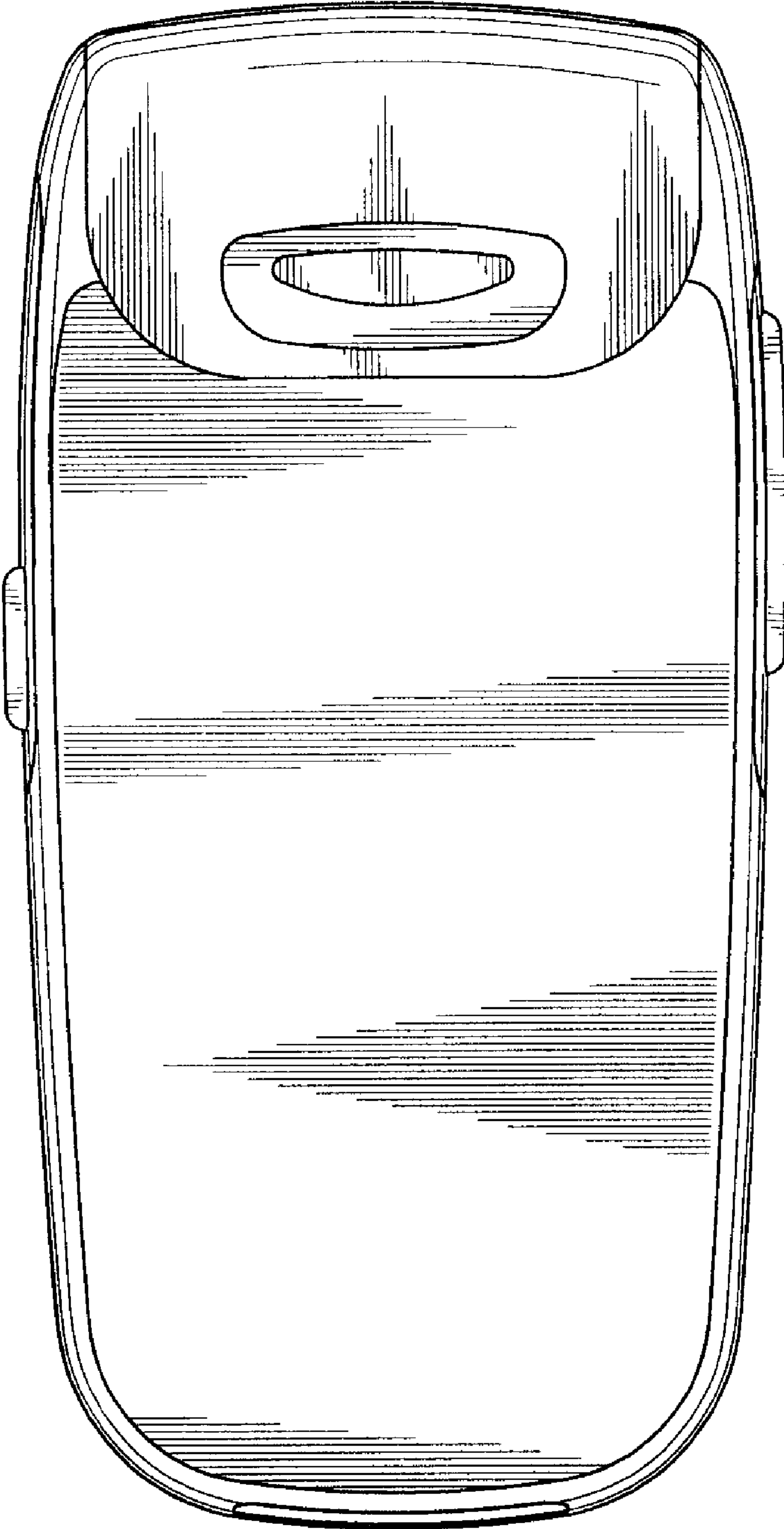

FIG. 3

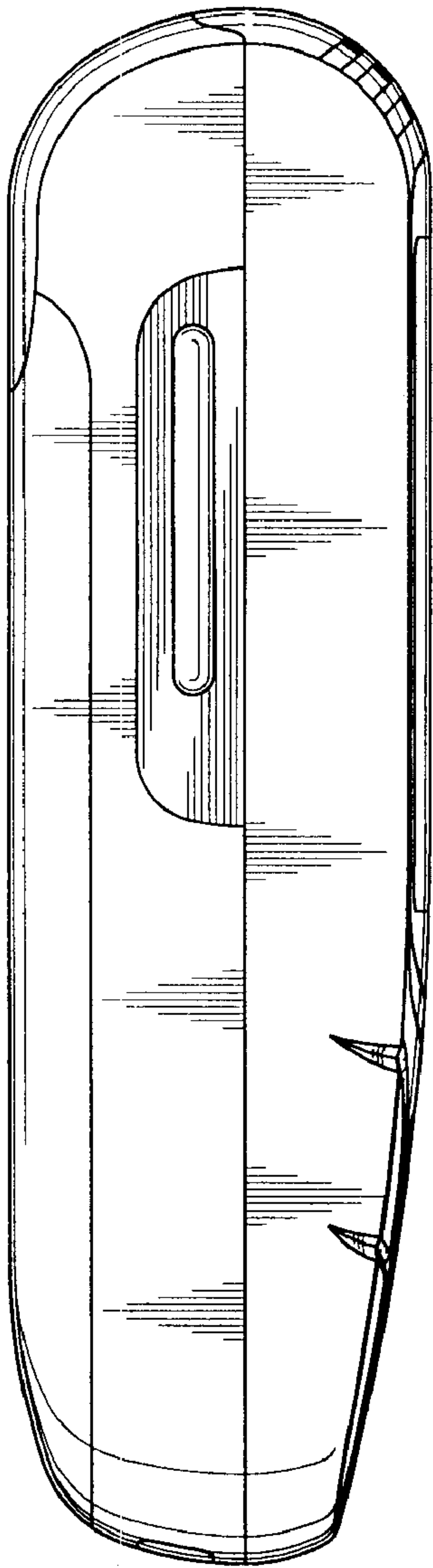

FIG. 4

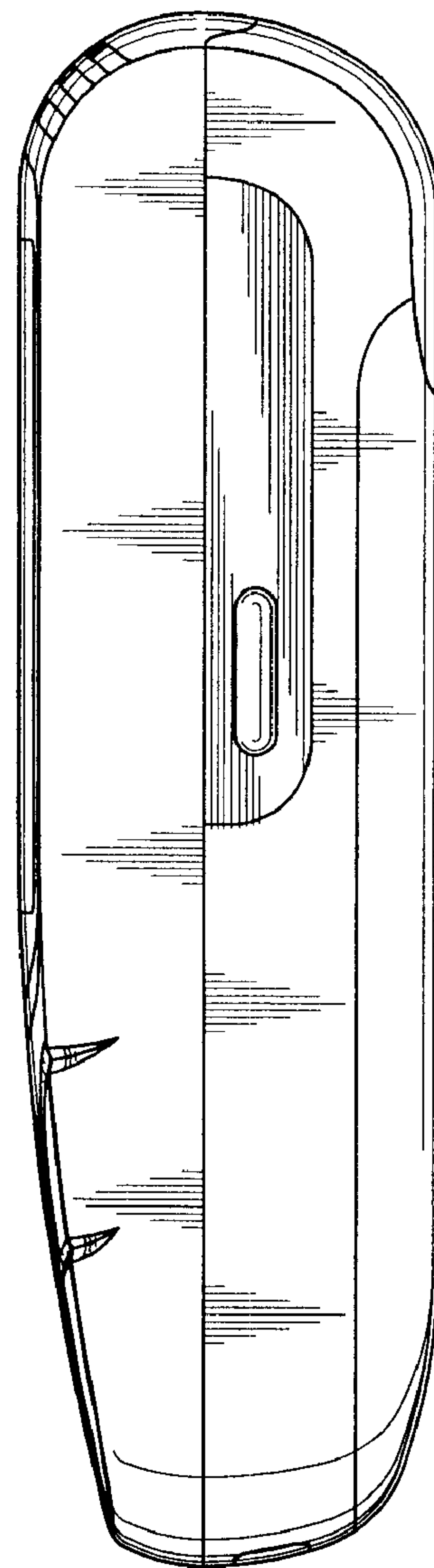

FIG. 5

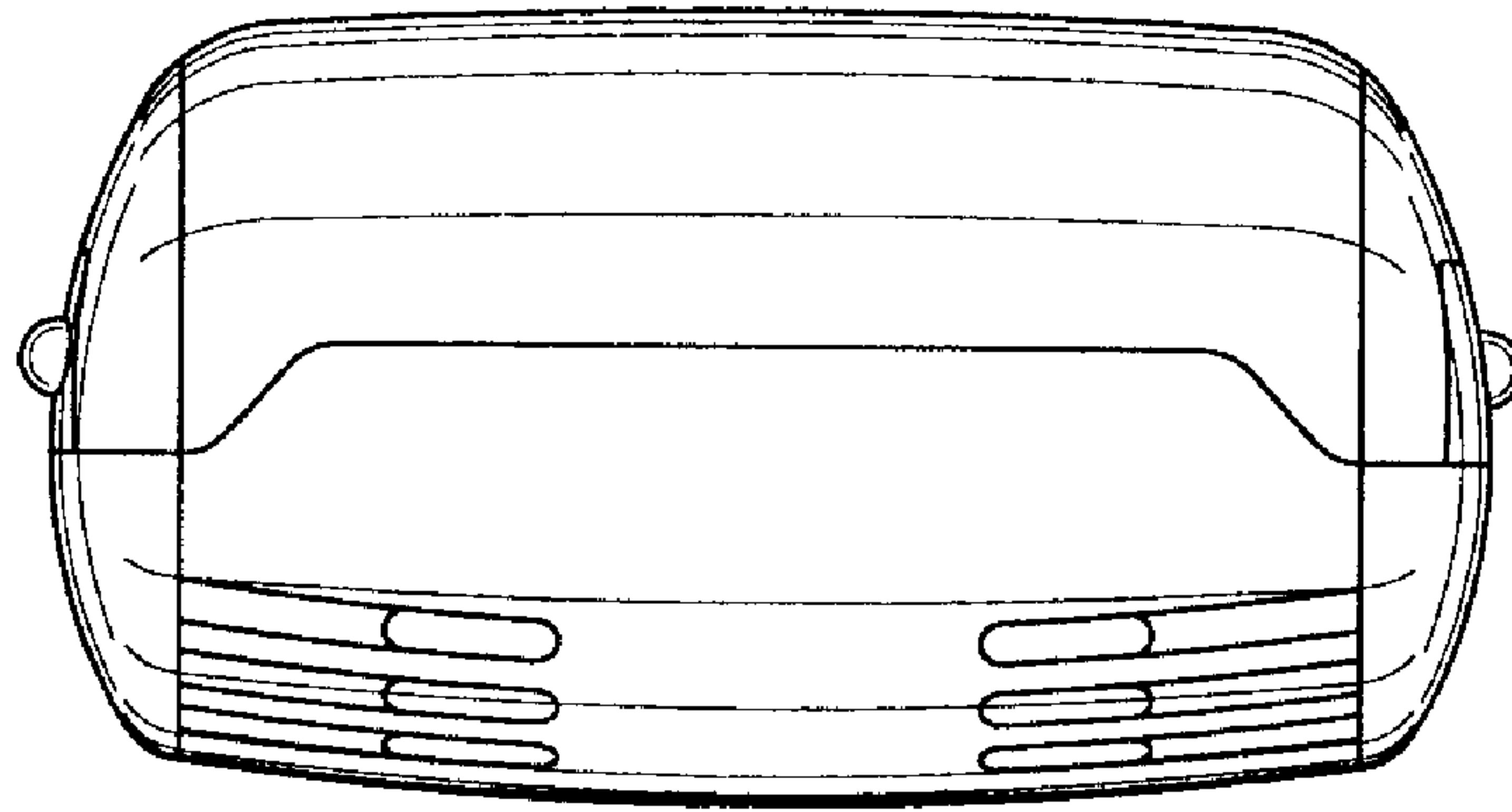

FIG. 6

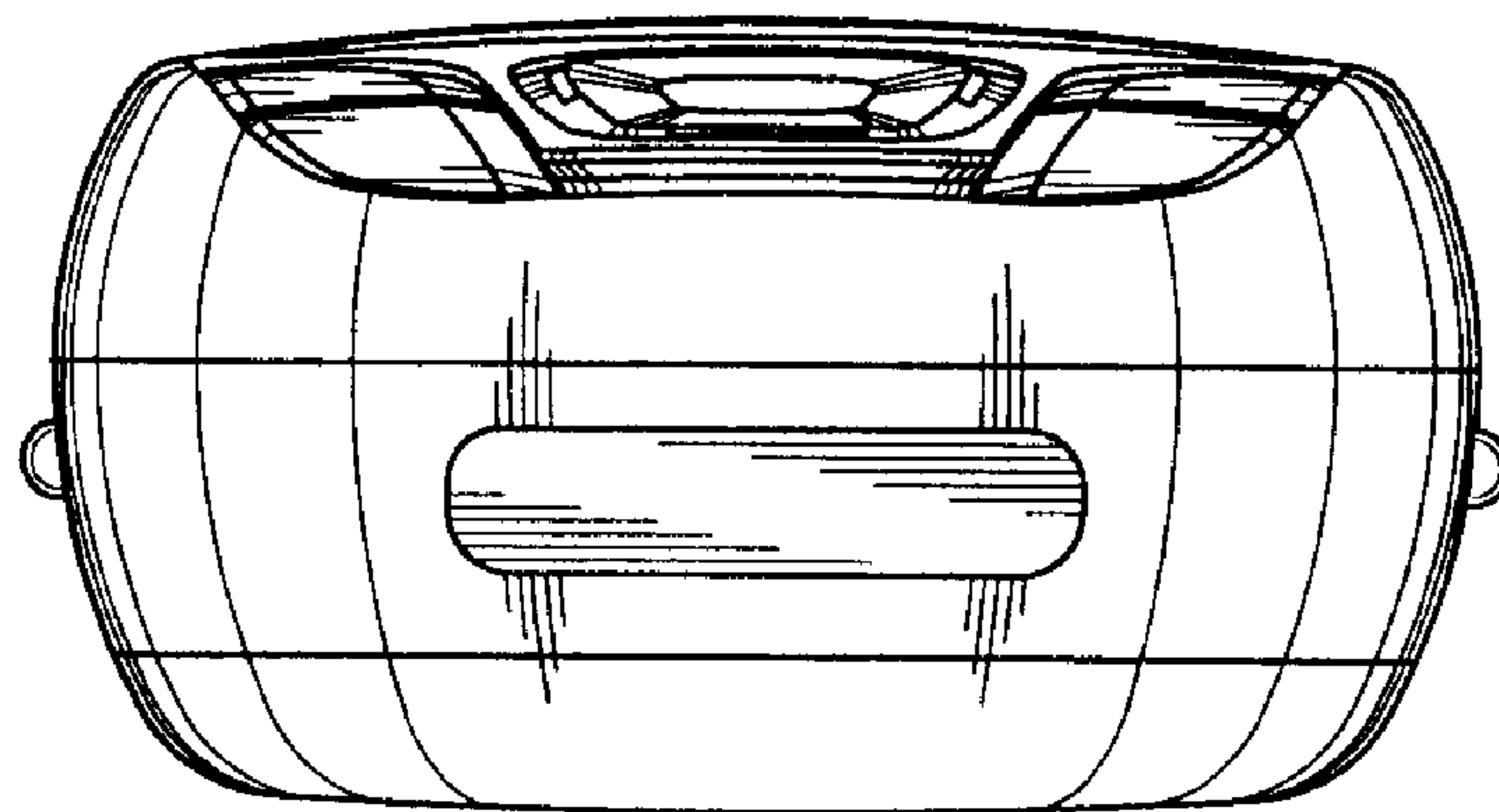

FIG. 7