



US00D529887S

(12) **United States Design Patent** (10) **Patent No.:** **US D529,887 S**
Chung et al. (45) **Date of Patent:** **** Oct. 10, 2006**

(54) **CELLULAR PHONE**

(75) Inventors: **Sung-Mo Chung**, Seoul (KR);
Jong-Seong Lee, Seoul (KR);
Chang-Hwan Hwang, Goyang-si (KR)

(73) Assignee: **Samsung Electronics Co., Ltd.** (KR)

(**) Term: **14 Years**

(21) Appl. No.: **29/221,578**

(22) Filed: **Jan. 17, 2005**

(30) **Foreign Application Priority Data**

Nov. 16, 2004 (KR) 30-2004-0034960

(51) **LOC (8) Cl.** **14-03**

(52) **U.S. Cl.** **D14/138**

(58) **Field of Classification Search** D14/137,
D14/138, 147-148, 247-248, 144, 341-347;
379/433.01-433.13; 455/575.4, 566, 575.1,
455/556.1, 556.2, 90.3; D16/208
See application file for complete search history.

(56) **References Cited**

U.S. PATENT DOCUMENTS

D312,628	S	*	12/1990	Yokoi et al.	D14/346
D466,096	S	*	11/2002	Takada	D14/138
D503,164	S	*	3/2005	Park et al.	D14/138
D508,240	S	*	8/2005	Lee et al.	D14/138
D508,473	S	*	8/2005	Lee et al.	D14/138
D508,688	S	*	8/2005	Lee et al.	D14/138
D509,202	S	*	9/2005	Lee et al.	D14/138
D509,206	S	*	9/2005	Jang	D14/138
D511,342	S	*	11/2005	Chien	D14/346
D515,060	S	*	2/2006	Lee et al.	D14/138
2004/0259592	A1	*	12/2004	Taneyra et al.	455/556.1
2005/0107126	A1	*	5/2005	Kim	455/565
2005/0124381	A1	*	6/2005	Kim et al.	455/556.1
2005/0215298	A1	*	9/2005	Lee	455/575.4
2005/0245297	A1	*	11/2005	Lee et al.	455/575.4
2005/0255897	A1	*	11/2005	Lee et al.	455/575.4
2005/0266897	A1	*	12/2005	Ahn et al.	455/575.1
2006/0009255	A1	*	1/2006	Vuolteenaho	455/556.1
2006/0025184	A1	*	2/2006	Cho et al.	455/575.4

OTHER PUBLICATIONS

LG M6100 telephone, announced Jan. 2006, [online], [retrieved on Mar. 26, 2006]. Retrieved from Internet ,URL: <http://www.gsmarena.com>>.*

Samsung D710 telephone, announced first quarter 2004, [online], [retrieved on Mar. 26, 2006]. Retrieved from Internet ,URL: <http://www.gsmarena.com>>.*

Samsung S400i telephone, announced Feb. 2006, [online], [retrieved on Mar. 1, 2006]. Retrieved from Internet ,URL: <http://www.gsmarena.com>>.*

Samsung D800 telephone, announced fourth quarter 2005, [online], [retrieved on Mar. 26, 2006]. Retrieved from Internet ,URL: <http://www.gsmarena.com>>.*

Philips 960 telephone, announced Jul. 2005, [online], [retrieved on Mar. 26, 2006]. Retrieved from Internet ,URL: <http://www.gsmarena.com>>.*

XCute DV80 telephone, announced Feb. 2006, [online], [retrieved on Mar. 26, 2006]. Retrieved from Internet ,URL: <http://www.gsmarena.com>>.*

* cited by examiner

Primary Examiner—Jeffrey Asch

(74) *Attorney, Agent, or Firm*—Cantor Colburn LLP

(57) **CLAIM**

We claim, the ornamental design for a cellular phone, as shown and described.

DESCRIPTION

FIG. 1 is a top and front perspective view of a cellular phone, showing our new design;

FIG. 2 is a front elevational view thereof;

FIG. 3 is a rear elevational view thereof;

FIG. 4 is a left side elevational view thereof;

FIG. 5 is a right side elevational view thereof;

FIG. 6 is a top elevational view thereof;

FIG. 7 is a bottom elevational view thereof; and,

FIG. 8 is a front perspective view thereof, the cellular phone being proximate to an exemplary cover.

The broken line showing of an exemplary cover in FIG. 8 is included for illustrative purposes only and forms no part of the claimed design.

1 Claim, 4 Drawing Sheets

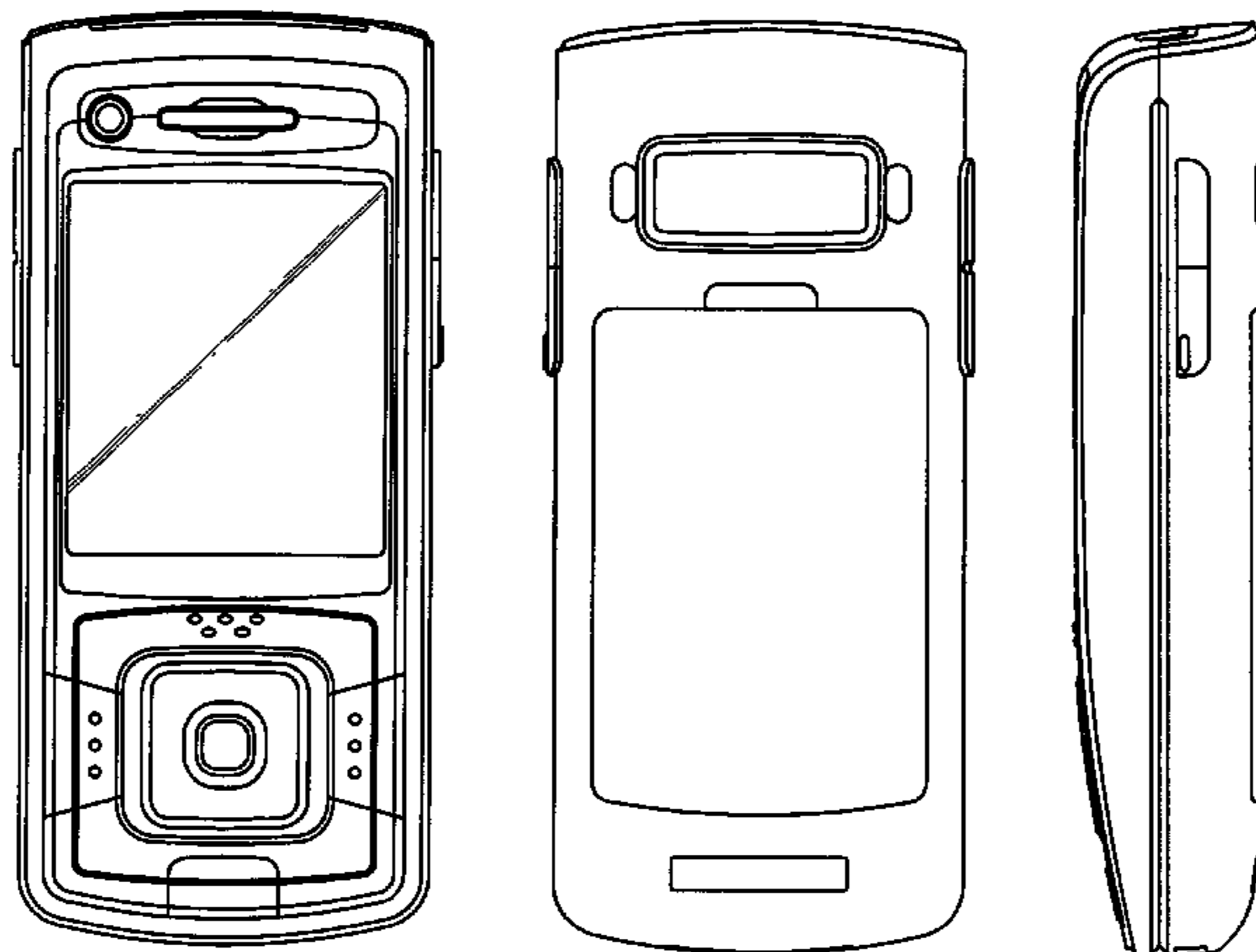

FIG. 1

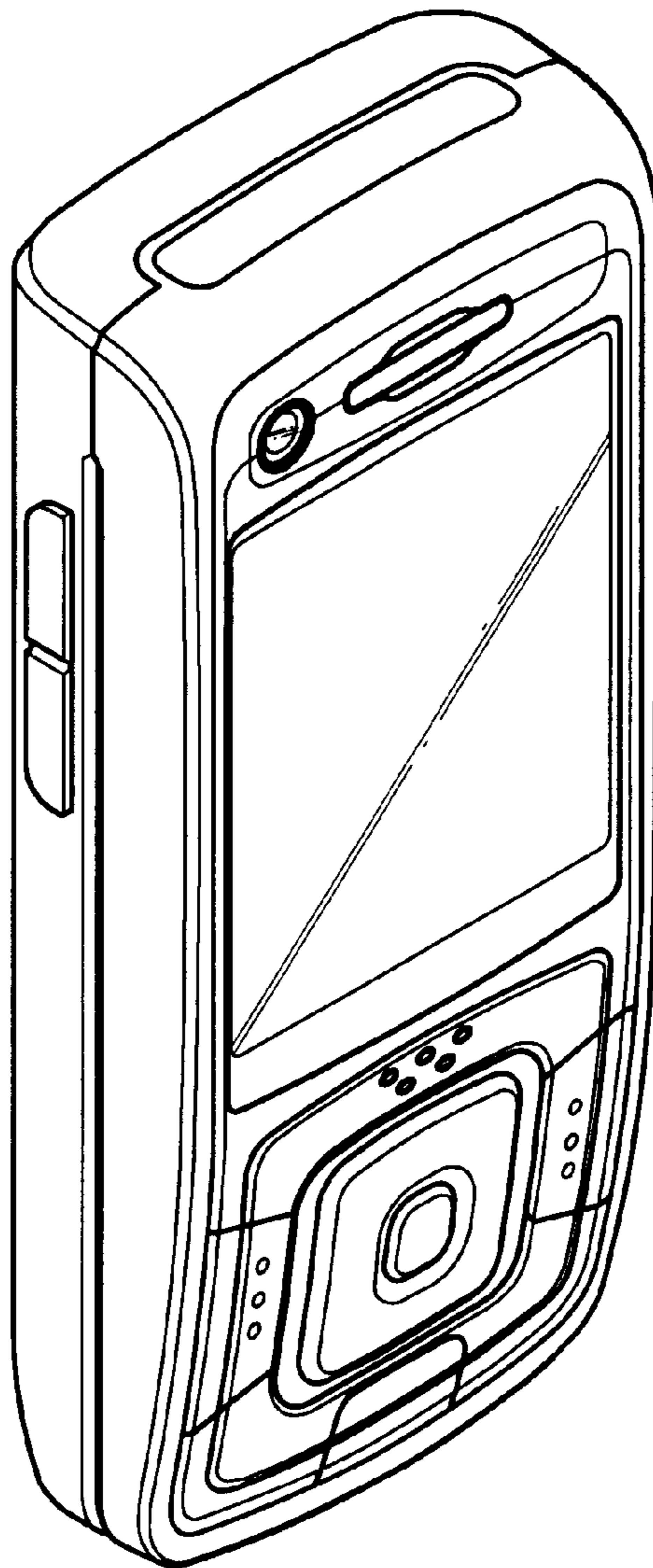

FIG. 2

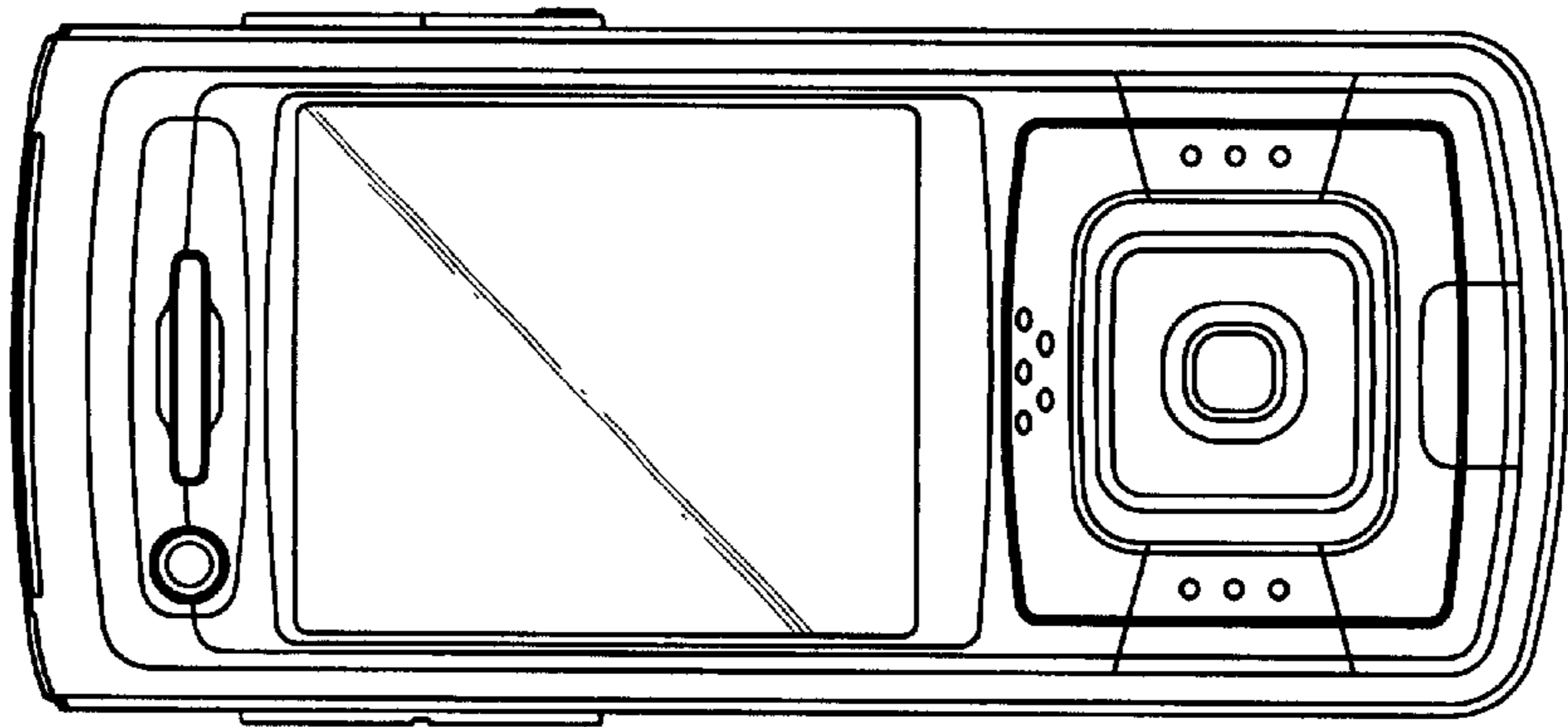

FIG. 3

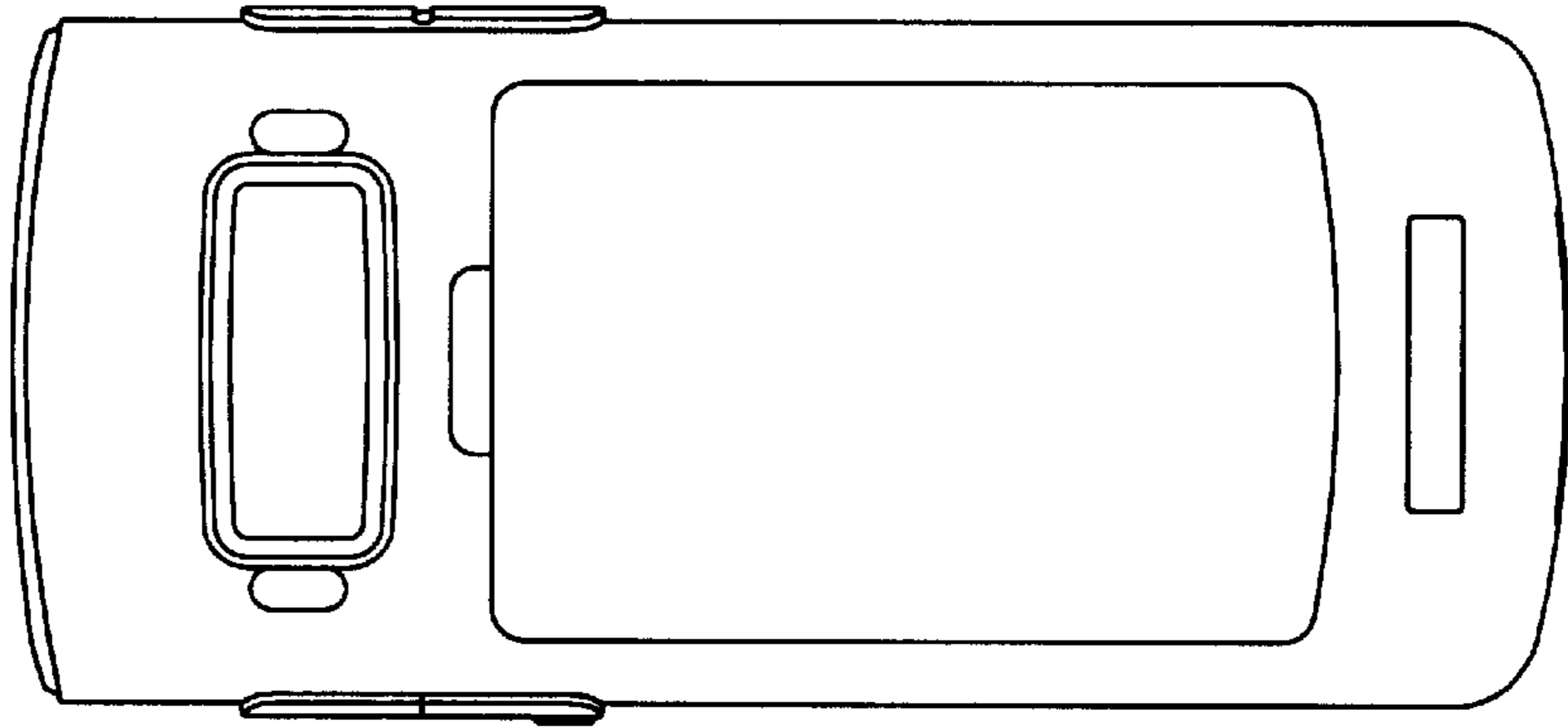

FIG. 4

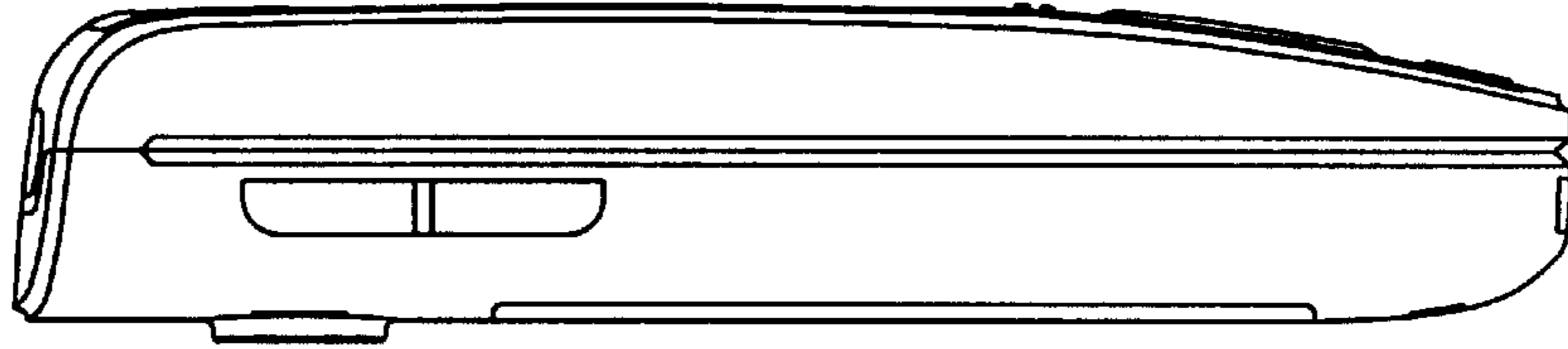

FIG. 5

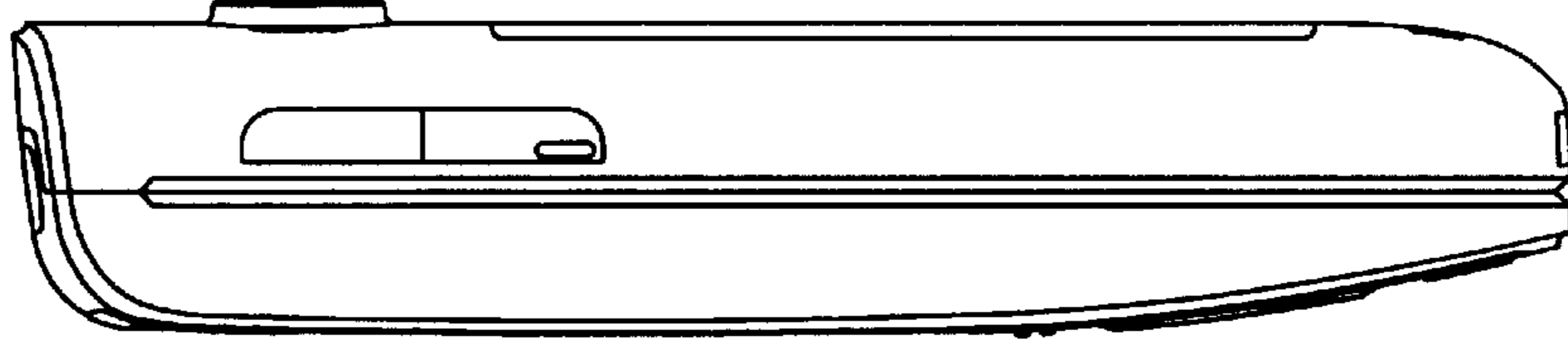

FIG. 6

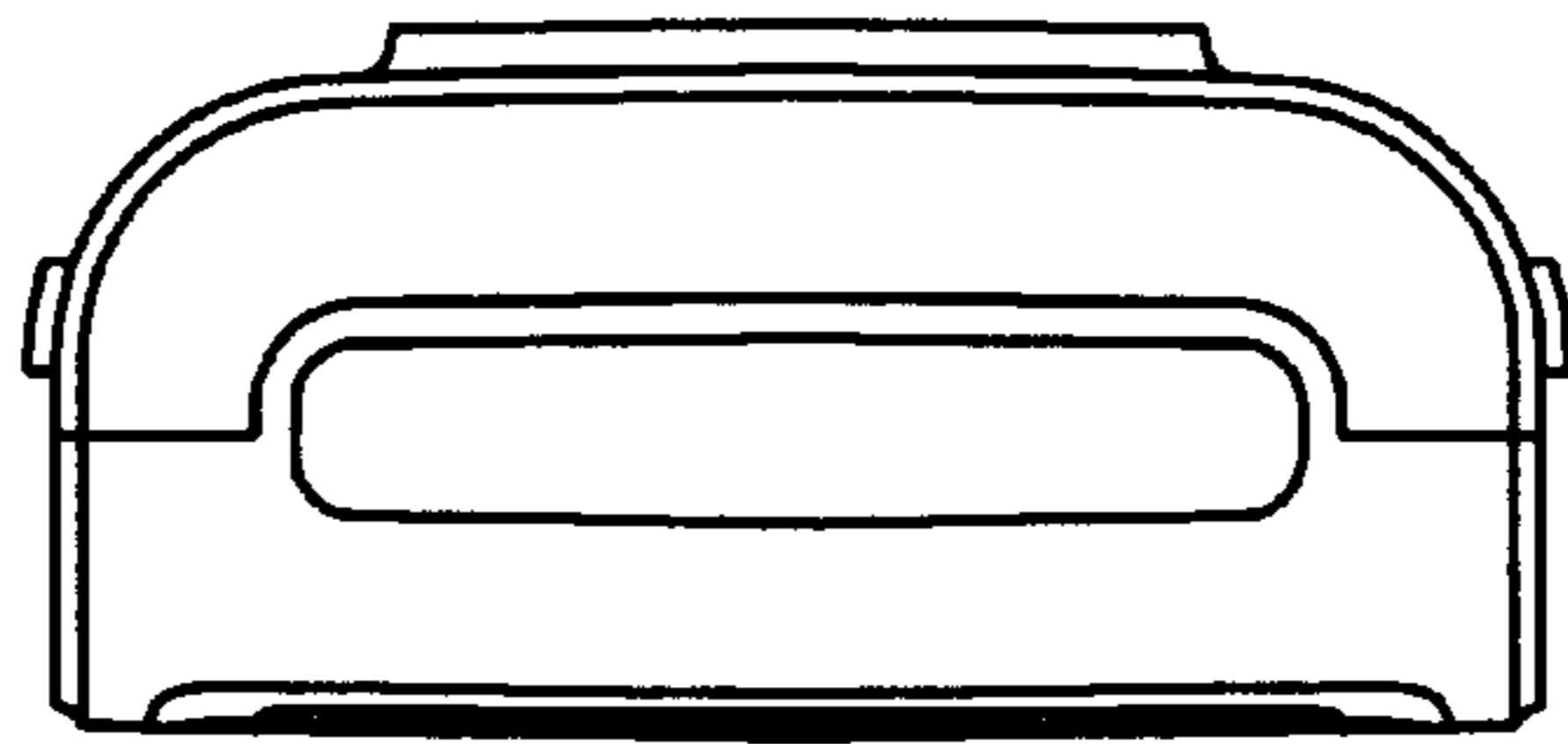

FIG. 7

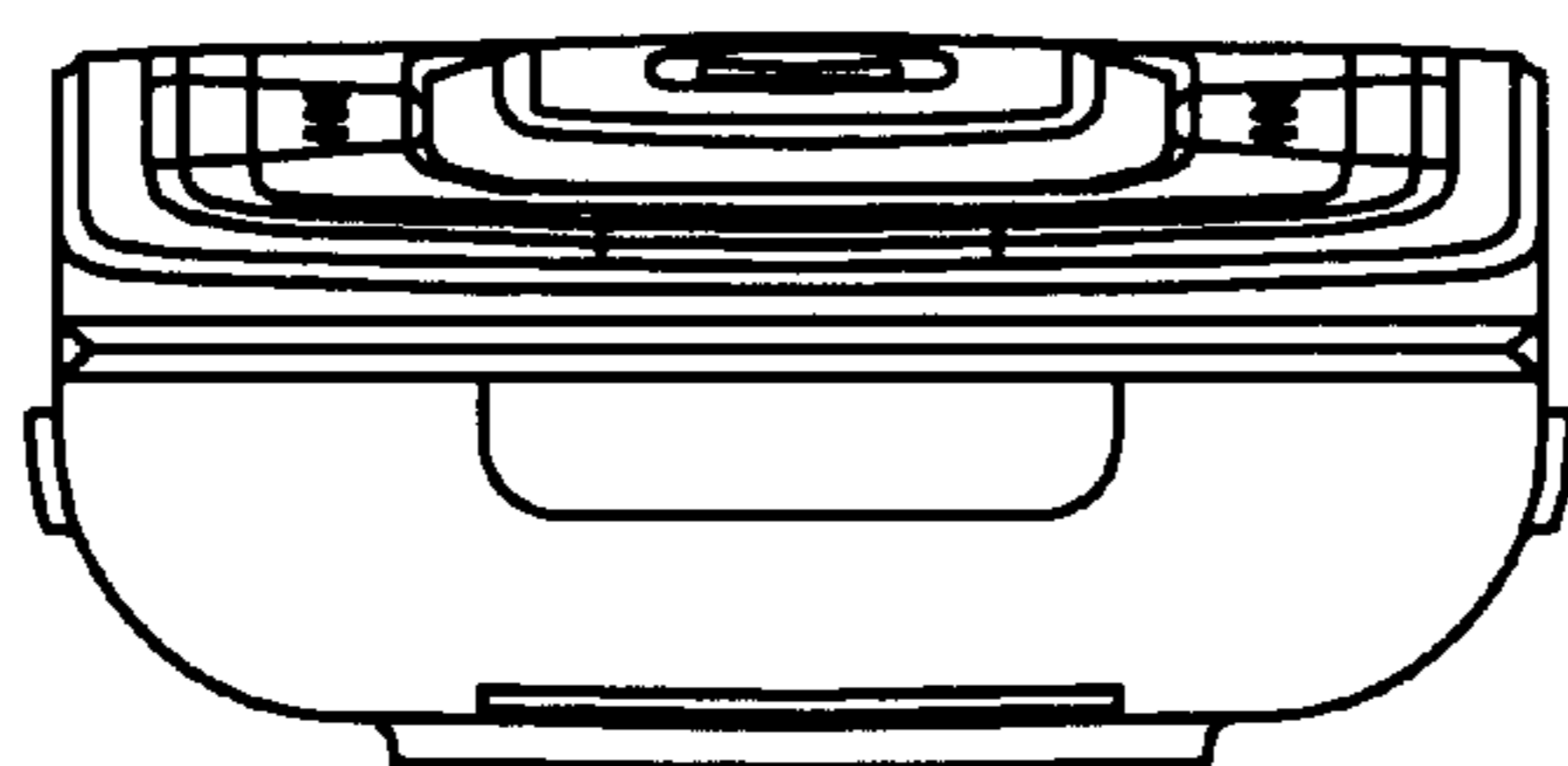

FIG. 8

