

US00D529799S

(12) **United States Design Patent**  
**Jensen**

(10) **Patent No.:** **US D529,799 S**

(45) **Date of Patent:** **\*\* Oct. 10, 2006**

(54) **POURER WITH CLOSURE**

(75) Inventor: **Claus Jensen**, Copenhagen (DK)

(73) Assignee: **Eva Denmark A/S**, Malov (DK)

(\*\*) Term: **14 Years**

(21) Appl. No.: **29/245,577**

(22) Filed: **Dec. 22, 2005**

(51) **LOC (8) Cl.** ..... **09-07**

(52) **U.S. Cl.** ..... **D9/447; D7/397**

(58) **Field of Classification Search** ..... D9/453,  
D9/452, 449, 447, 443, 440, 439, 435; D7/415,  
D7/398, 397, 312; 401/90; 251/353; 239/337;  
222/557, 556, 548, 402, 402.21, 402.13  
See application file for complete search history.

(56) **References Cited**

**U.S. PATENT DOCUMENTS**

2,898,017	A	*	8/1959	Redmond	.....	222/519
3,386,626	A	*	6/1968	Kearney	.....	222/147
D284,553	S	*	7/1986	Collister	.....	D9/435
4,765,518	A	*	8/1988	O'Meara	.....	222/541.9
4,927,058	A	*	5/1990	Nimmey et al.	.....	222/106
D368,856	S	*	4/1996	Peay	.....	D9/447
D379,304	S	*	5/1997	Bova	.....	D9/447
D388,705	S	*	1/1998	Miller et al.	.....	D9/447
D490,315	S	*	5/2004	Kiser	.....	D9/445

\* cited by examiner

*Primary Examiner*—Robert M. Spear

*Assistant Examiner*—Susan Bennett Hattan

(74) *Attorney, Agent, or Firm*—William J. Sapone;  
Coleman Sudol Sapone P.C.

(57) **CLAIM**

I claim the ornamental design for a pourer with closure, as shown and described.

**DESCRIPTION**

The intended use of the pourer with closure is for mounting in the discharge opening of a container.

FIG. 1 is a front perspective view of the pourer with closure showing my new design;

FIG. 2 is a front perspective view of the pourer with closure of FIG. 1 with the closure removed for full disclosure;

FIG. 3 is a bottom perspective view thereof;

FIG. 4 is a cross sectional view thereof;

FIG. 5 is a side view thereof;

FIG. 6 is a top view thereof;

FIG. 7 is a bottom view thereof; and,

FIG. 8 is a bottom perspective view of the pourer with closure with the pourer removed for full disclosure;

FIG. 9 is a top perspective view thereof;

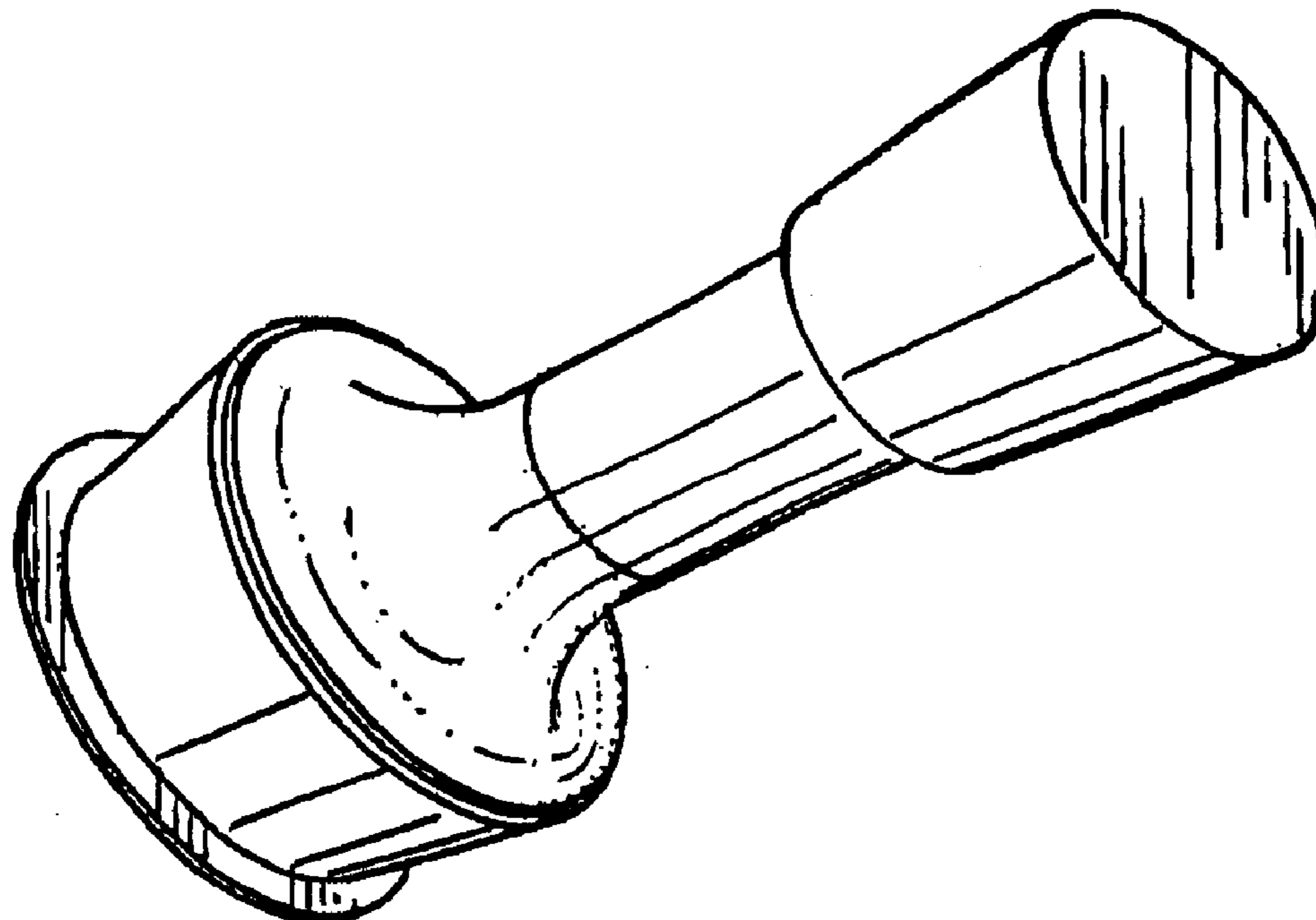
FIG. 10 is a cross sectional view thereof;

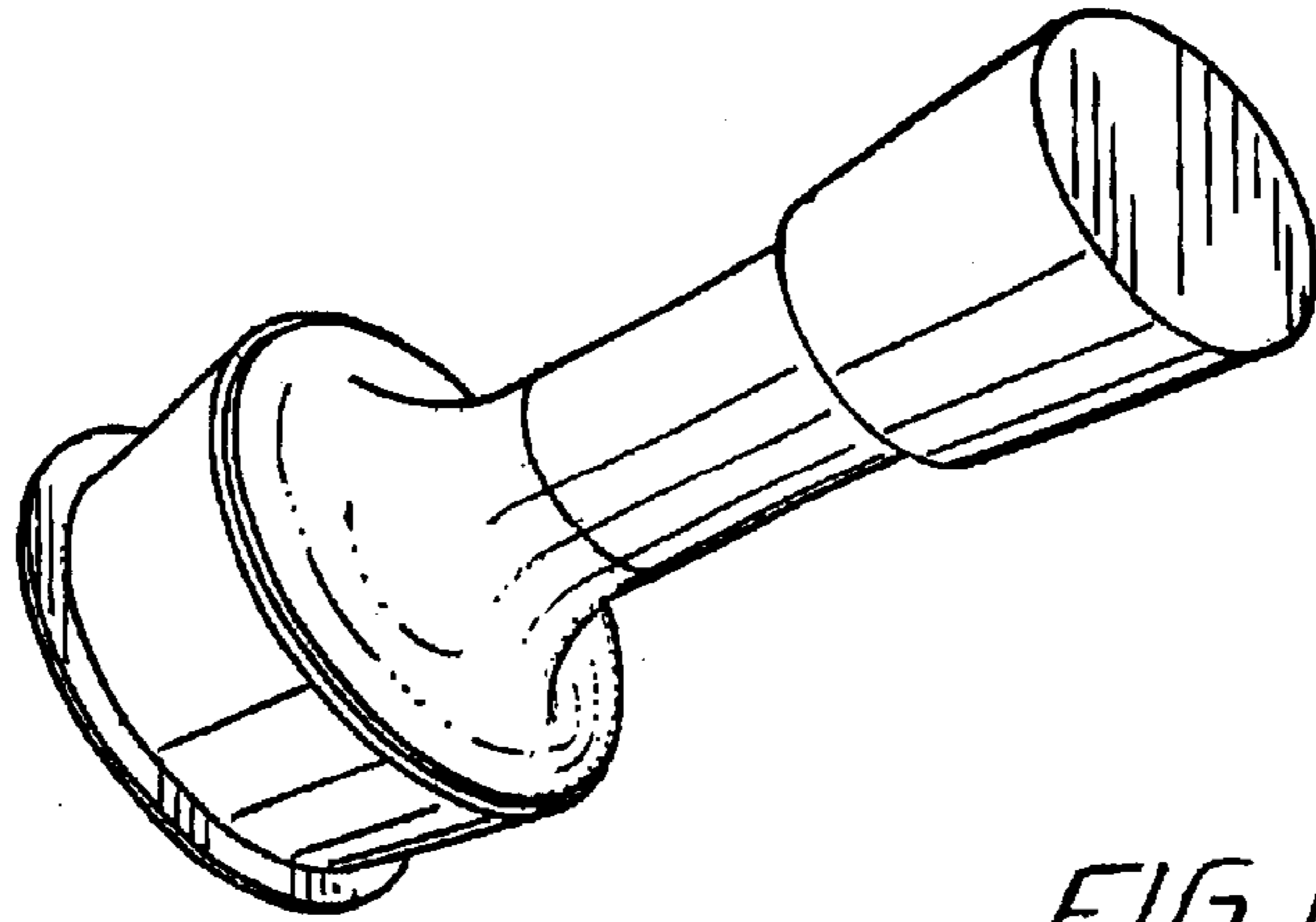
FIG. 11 is a side view thereof;

FIG. 12 is a top view thereof; and,

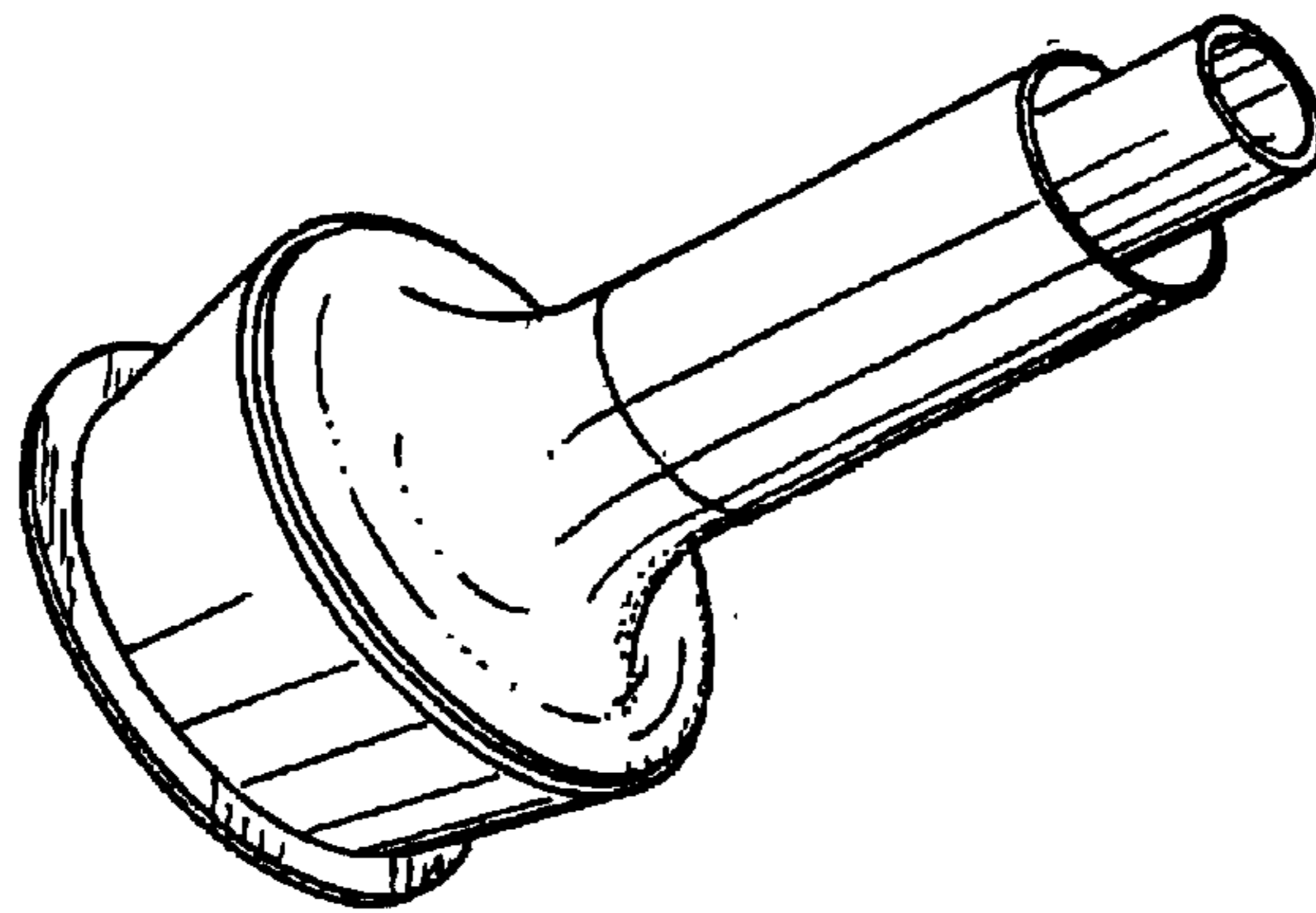
FIG. 13 is a bottom view thereof.

**1 Claim, 3 Drawing Sheets**

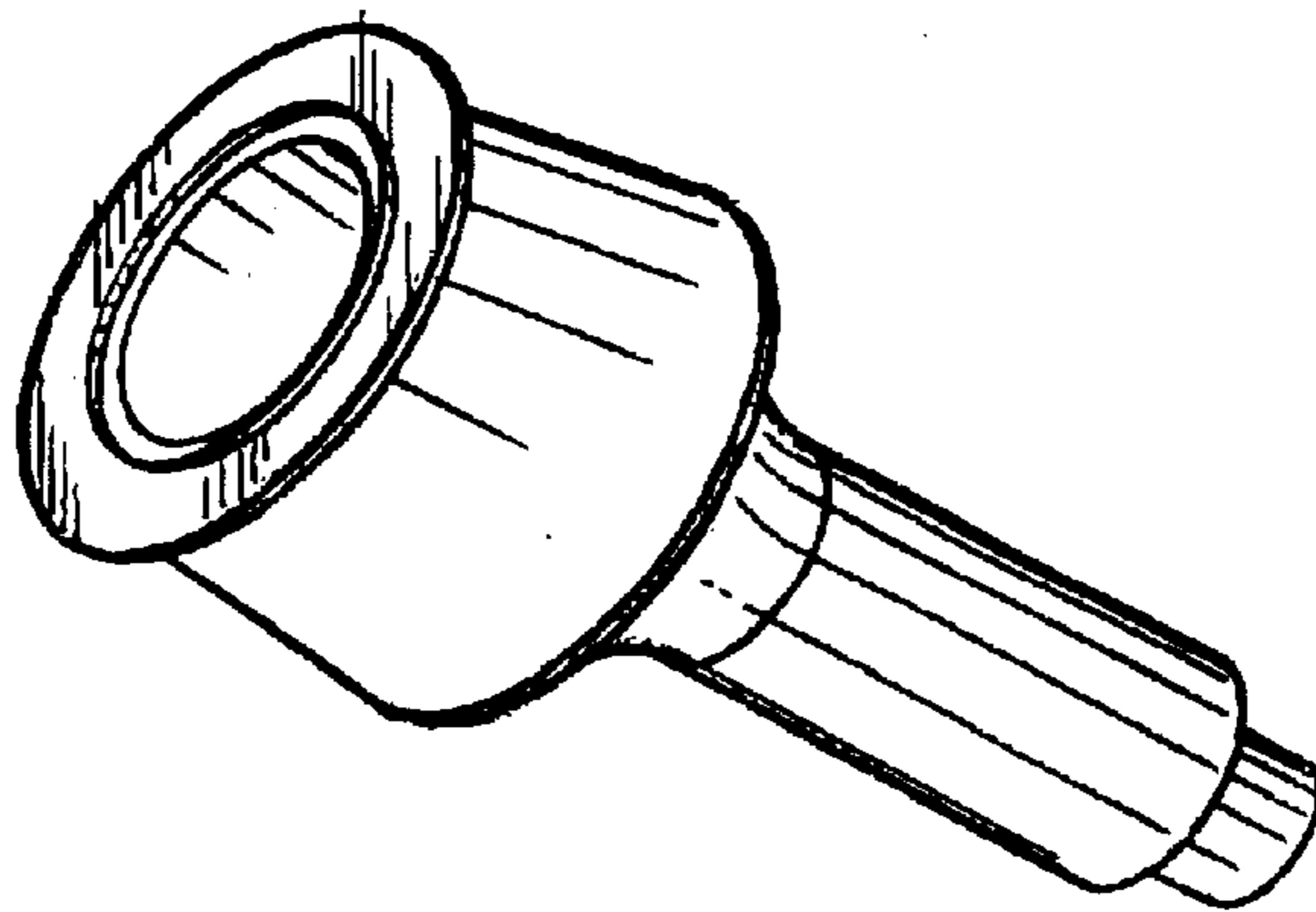




*FIG. 1*



*FIG. 2*



*FIG. 3*

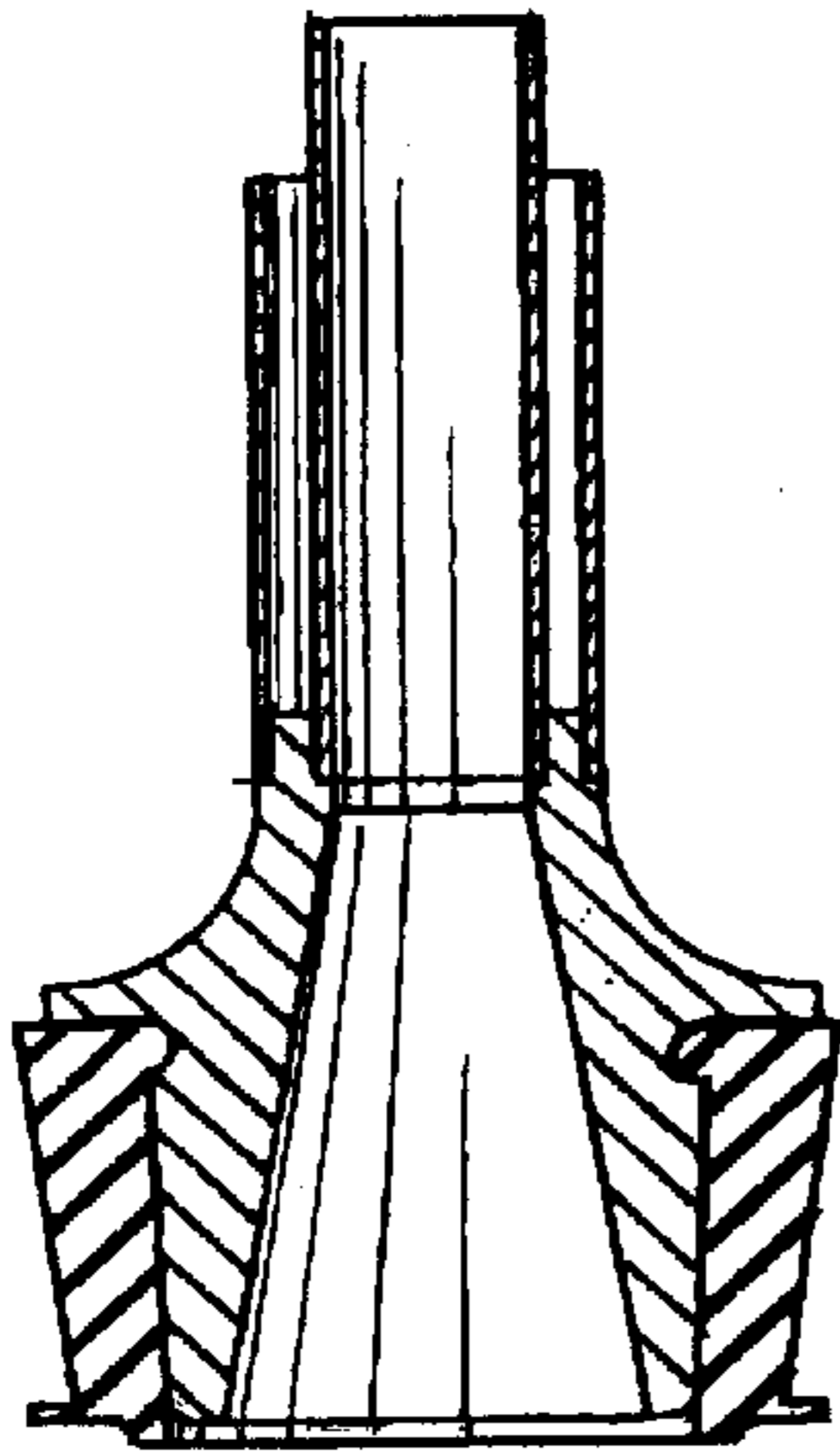


FIG. 4

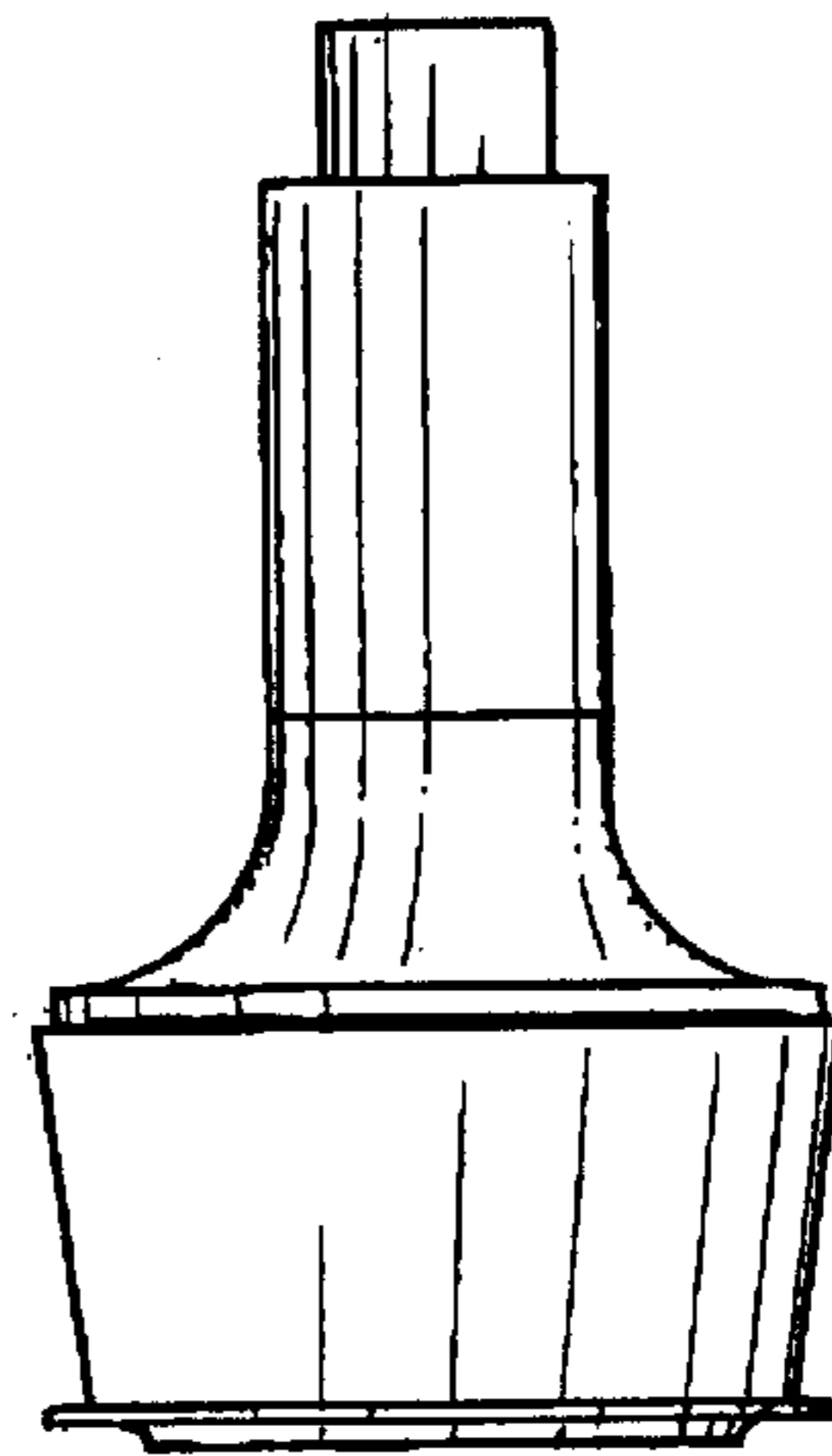


FIG. 5

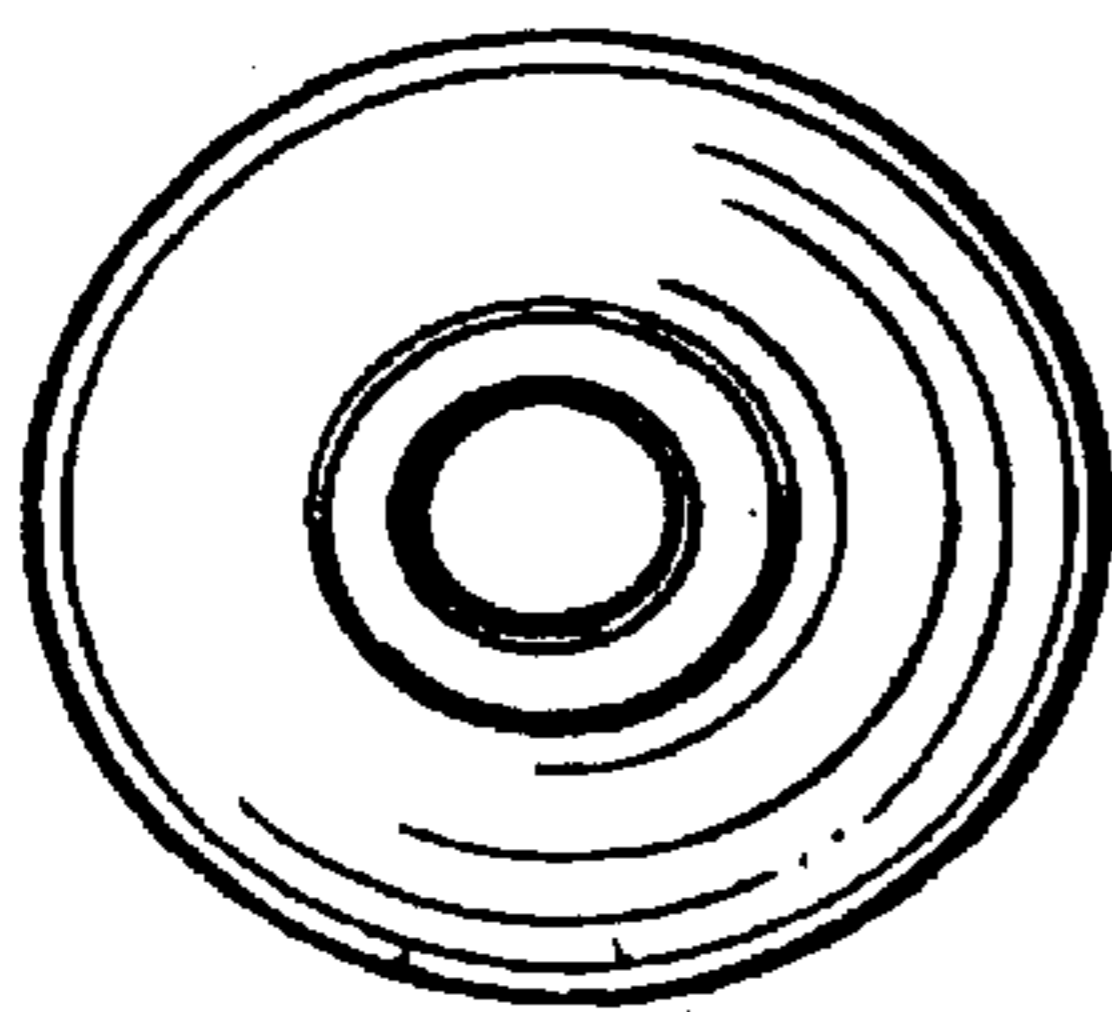


FIG. 6

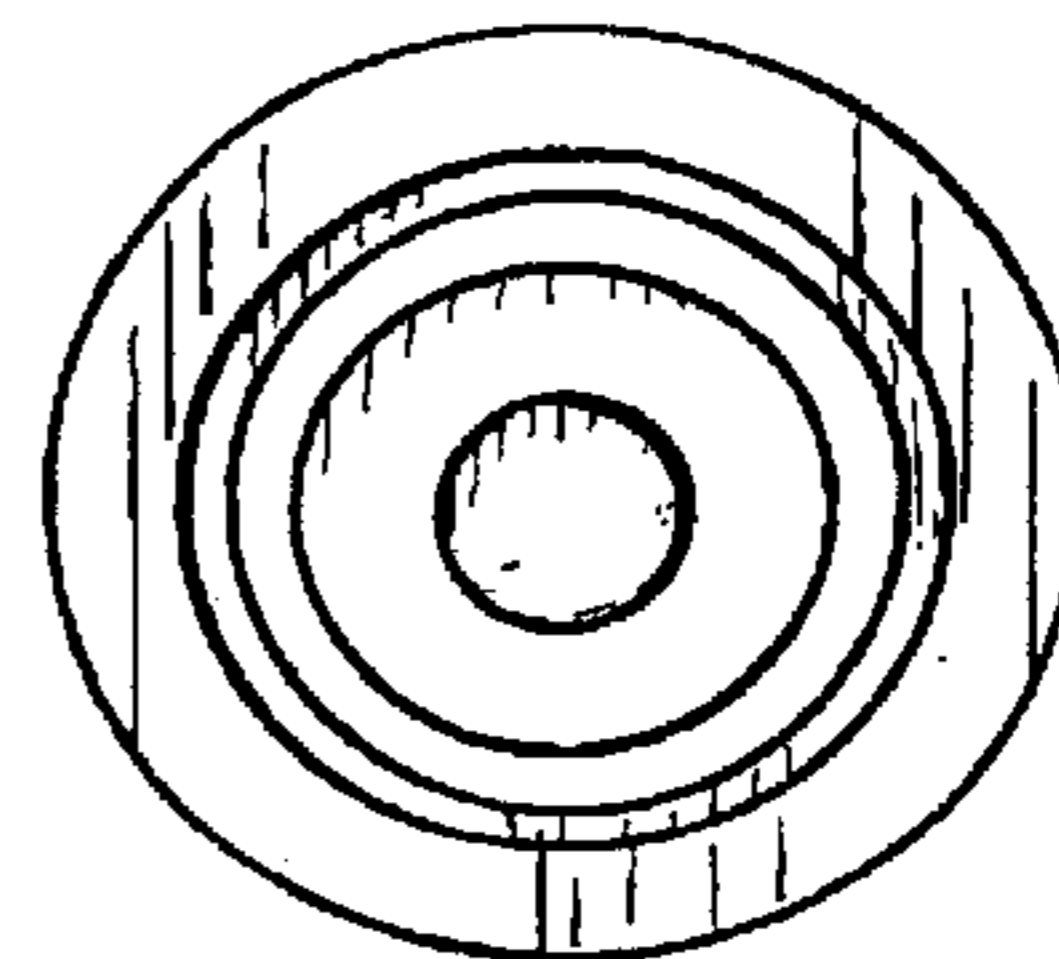


FIG. 7

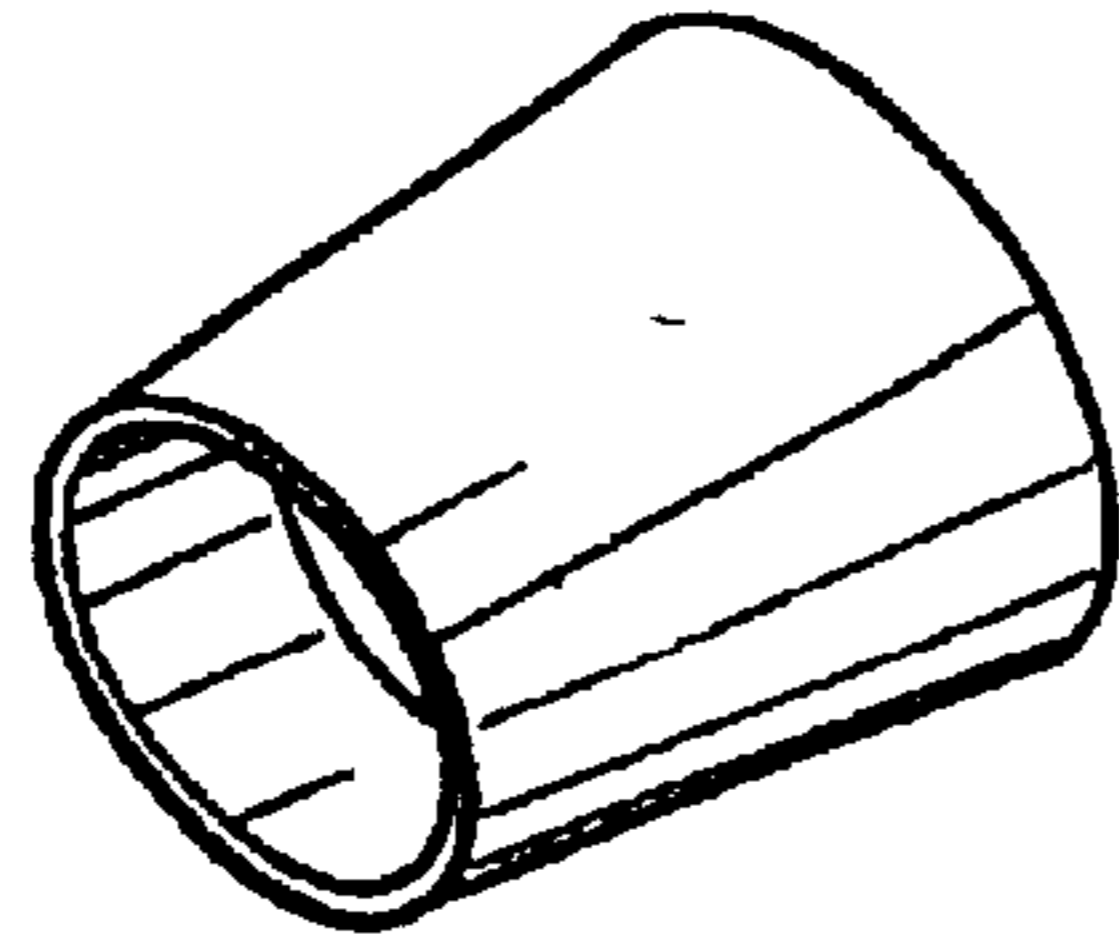


FIG. 8

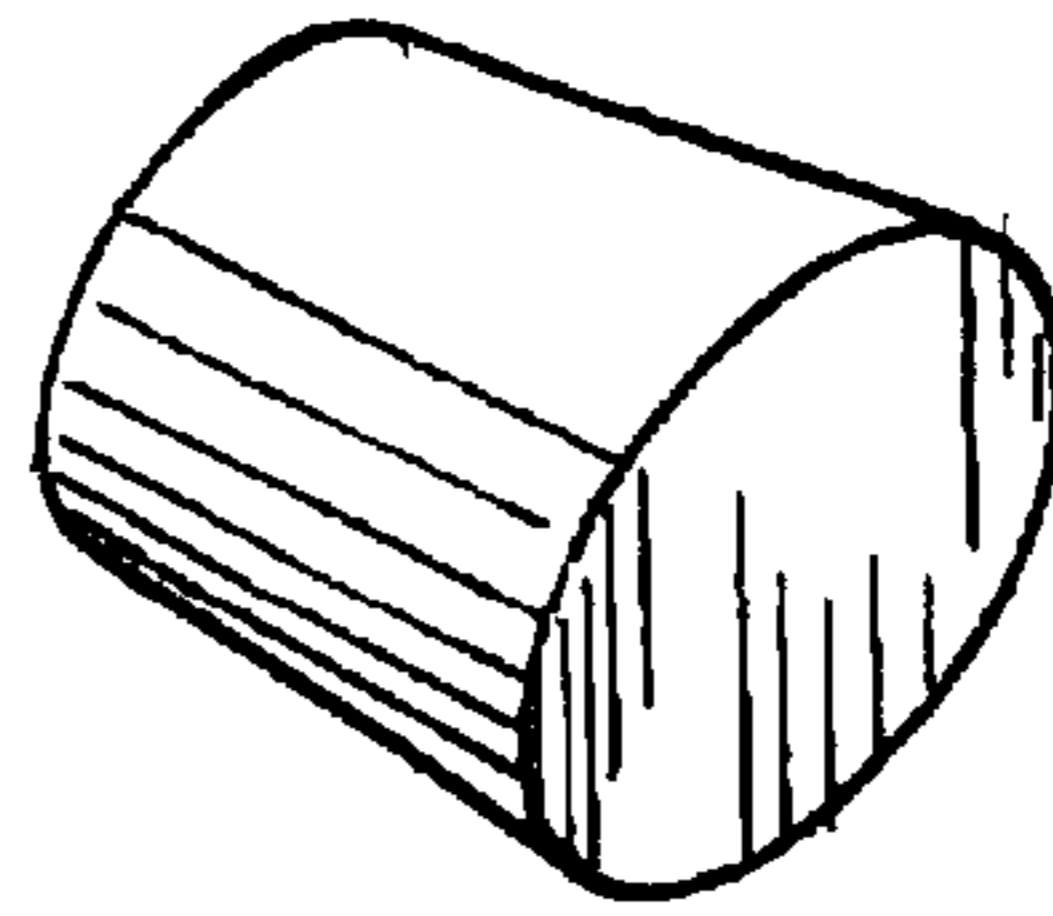


FIG. 9

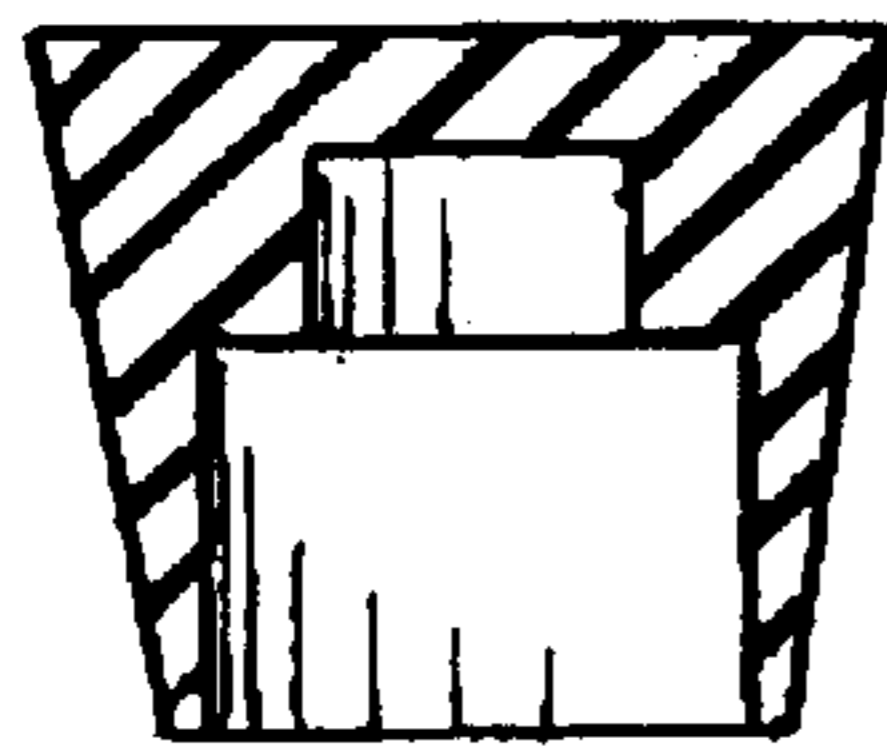


FIG. 10

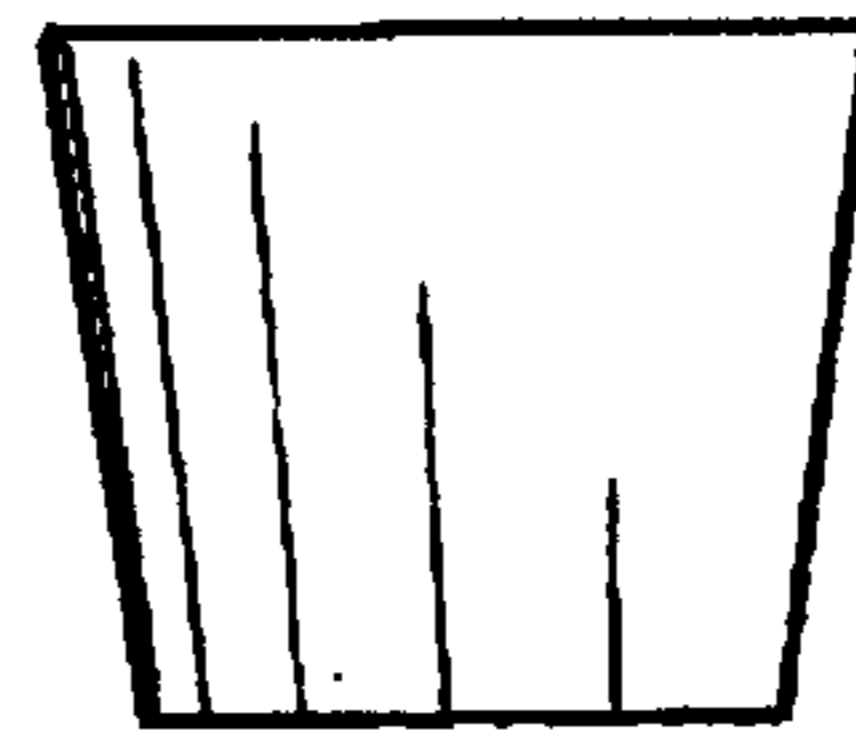


FIG. 11

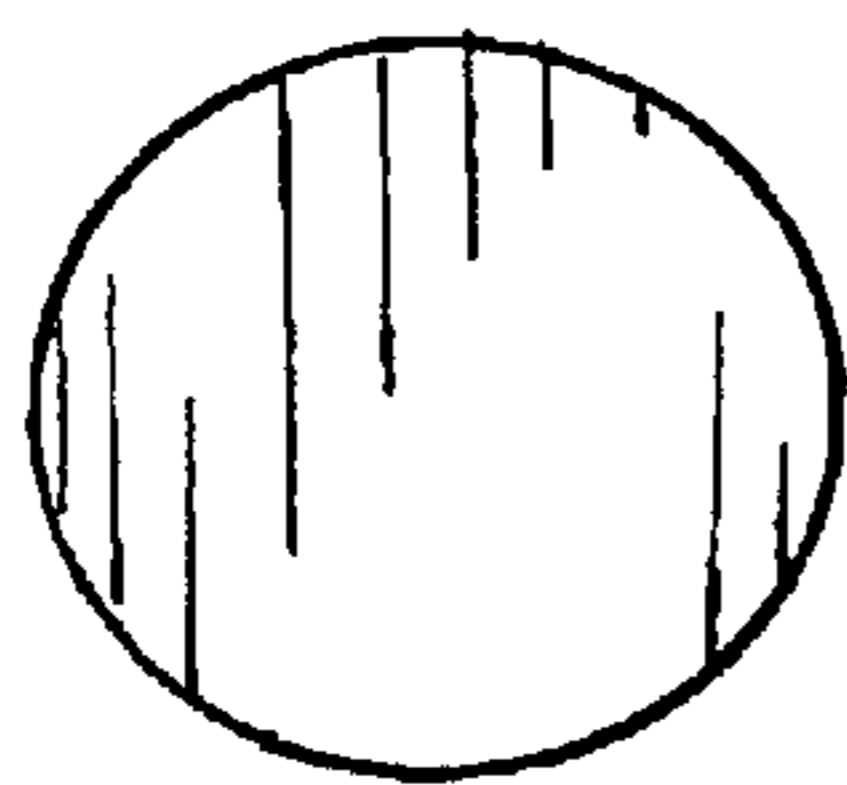


FIG. 12

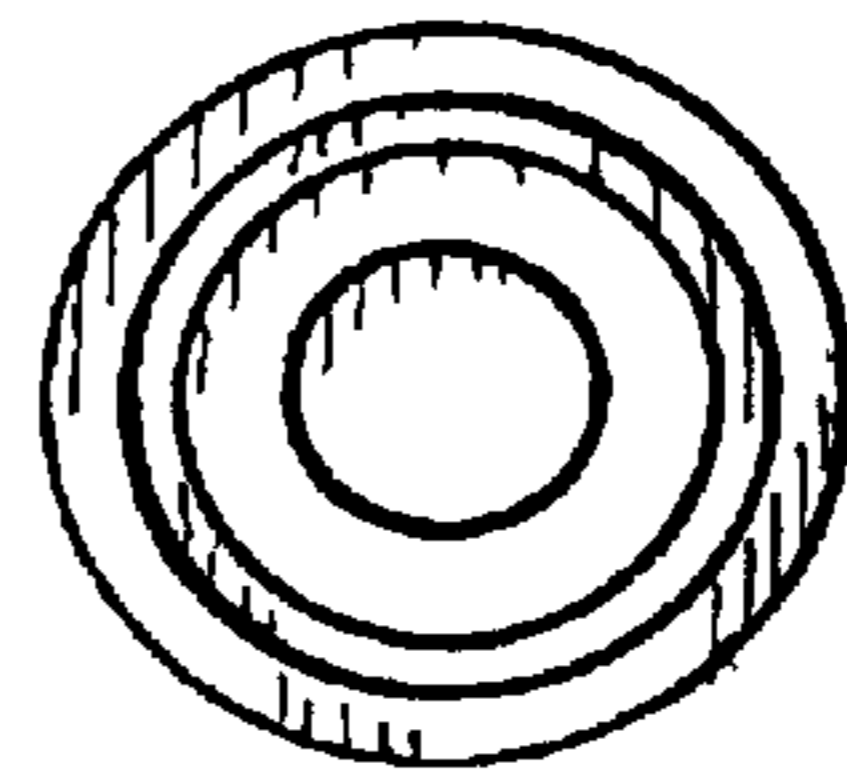


FIG. 13