



US00D529797S

(12) **United States Design Patent**
Wilcox et al.

(10) **Patent No.:** **US D529,797 S**
(45) **Date of Patent:** **** Oct. 10, 2006**

- (54) **FOOD TRAY**
- (75) Inventors: **Cindee Wilcox**, Newaygo, MI (US);
Daniel Preusser, Union, MO (US)
- (73) Assignee: **Novartis, AG**, Basel (CH)
- (**) Term: **14 Years**
- (21) Appl. No.: **29/238,379**
- (22) Filed: **Sep. 14, 2005**
- (51) **LOC (8) Cl.** **09-03**
- (52) **U.S. Cl.** **D9/428; D7/602**
- (58) **Field of Classification Search** D9/461,
D9/737, 424, 428, 425, 429; D7/554.2, 602,
D7/553.1, 549, 555, 550.1, 545, 500, 601;
206/557, 558; 229/406, 407; 220/675, 528,
220/553, 556, 669; 426/104, 116, 129, 130
See application file for complete search history.

- D339,522 S 9/1993 Zoss
- D343,338 S * 1/1994 Bucher et al. D7/543
- D367,172 S 2/1996 Brightbill et al.
- D371,940 S 7/1996 Krupa
- D372,170 S 7/1996 Ahern, Jr.
- D376,295 S 12/1996 Ahern et al.
- 5,624,051 A 4/1997 Ahern, Jr. et al.
- D384,555 S * 10/1997 Bradley D7/545
- D386,075 S 11/1997 Hayes et al.
- D387,272 S 12/1997 Lippincott
- D387,986 S 12/1997 Hayes et al.
- D388,699 S 1/1998 Hayes et al.
- D392,884 S 3/1998 Hayes
- 5,853,105 A 12/1998 Roman et al.
- D408,733 S 4/1999 McCann
- 5,919,501 A 7/1999 Rozzano
- 5,925,390 A 7/1999 Kornacki
- D415,421 S 10/1999 McCann

(Continued)

FOREIGN PATENT DOCUMENTS

GB 2205064 11/1988

Primary Examiner—Stella Reid
Assistant Examiner—Mark Goodwin
(74) *Attorney, Agent, or Firm*—Diane E. Furman; Michael F. Morgan

(56) **References Cited**

U.S. PATENT DOCUMENTS

- D41,766 S 9/1911 Bender
- 1,576,088 A 3/1926 Bunz
- D184,057 S 12/1958 Kearn
- 3,164,285 A 1/1965 Melich
- D206,547 S 12/1966 Swett
- D219,263 S 11/1970 Castelli et al.
- D223,146 S * 3/1972 Maasshoff D9/424
- D224,554 S 8/1972 Swett
- D232,302 S 8/1974 Lazure
- D235,498 S 6/1975 Day
- 4,081,646 A 3/1978 Goltzos
- 4,574,174 A 3/1986 McGonigle
- D283,666 S 5/1986 Holzkopf
- D284,727 S 7/1986 Gerber
- D288,063 S * 2/1987 Tyler D9/425
- D292,878 S 11/1987 Commisso et al.
- D293,769 S 1/1988 Gilardone, Jr.
- D301,192 S 5/1989 DeCoster
- D305,085 S 12/1989 Otto
- D312,896 S 12/1990 Goetz
- D316,359 S 4/1991 Anderson
- D339,030 S 9/1993 Bitel, Sr.

(57) **CLAIM**

The ornamental design for a food tray, as shown and described.

DESCRIPTION

FIG. 1 is a perspective view of a food tray showing our new design.
FIG. 2 is a top plan view of the food tray of FIG. 1.
FIG. 3 is a front elevational view of the food tray of FIG. 1.
FIG. 4 is a side elevational view of the food tray of FIG. 1.
FIG. 5 is a an opposite side elevational view of the food tray of FIG. 1.
FIG. 6 is a rear elevational view of the food tray of FIG. 1; and,
FIG. 7 is bottom plan view of the food tray of FIG. 1.

1 Claim, 5 Drawing Sheets

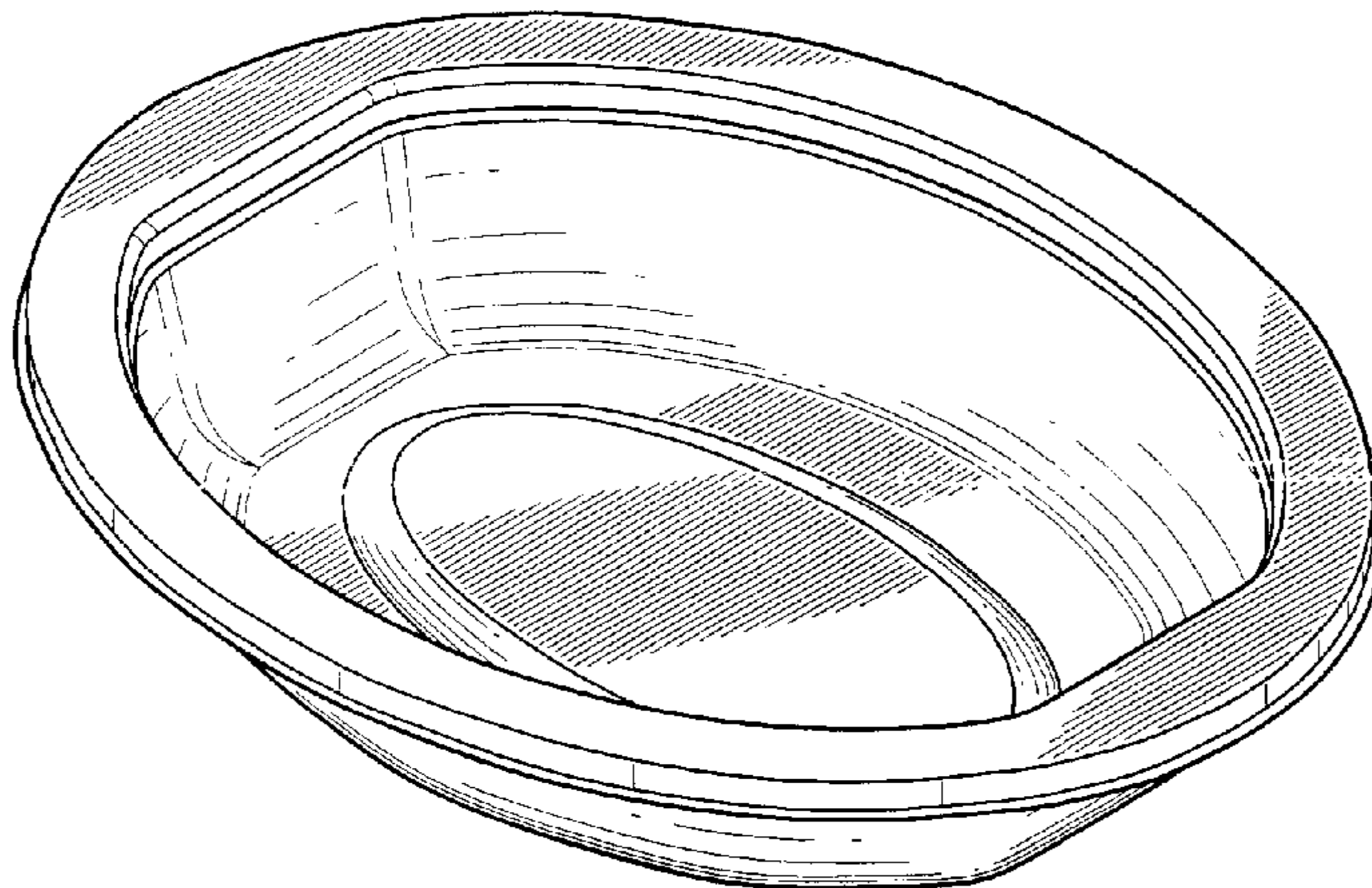

US D529,797 S

Page 2

U.S. PATENT DOCUMENTS

D416,751 S	11/1999	Sawyer et al.		
D417,366 S	12/1999	Obra		
D420,180 S	2/2000	Mason et al.		
D420,855 S	2/2000	Hurley		
D420,859 S	* 2/2000	Loew et al.	D7/602	
D433,592 S	11/2000	Hopkins		
D436,854 S	1/2001	Feldmeier		
6,187,354 B1	2/2001	Hopkins		
D441,615 S	5/2001	Dretzka		
D442,484 S	5/2001	Maxwell et al.		
D443,205 S	6/2001	Mangla et al.		
D446,085 S	8/2001	Dretzka		
D448,130 S	9/2001	Wagner		
D466,762 S	* 12/2002	Cote et al.	D7/545	
D477,187 S	* 7/2003	McCallister et al.	D7/545	
D483,999 S	12/2003	Beachum et al.		
D484,364 S	12/2003	Baily et al.		
D494,817 S	* 8/2004	Rutter et al.	D7/543	
D497,774 S	* 11/2004	Smith et al.	D7/543	
D499,936 S	* 12/2004	Wiedmeyer et al.	D7/545	
D508,822 S	* 8/2005	Smith et al.	D7/545	

* cited by examiner

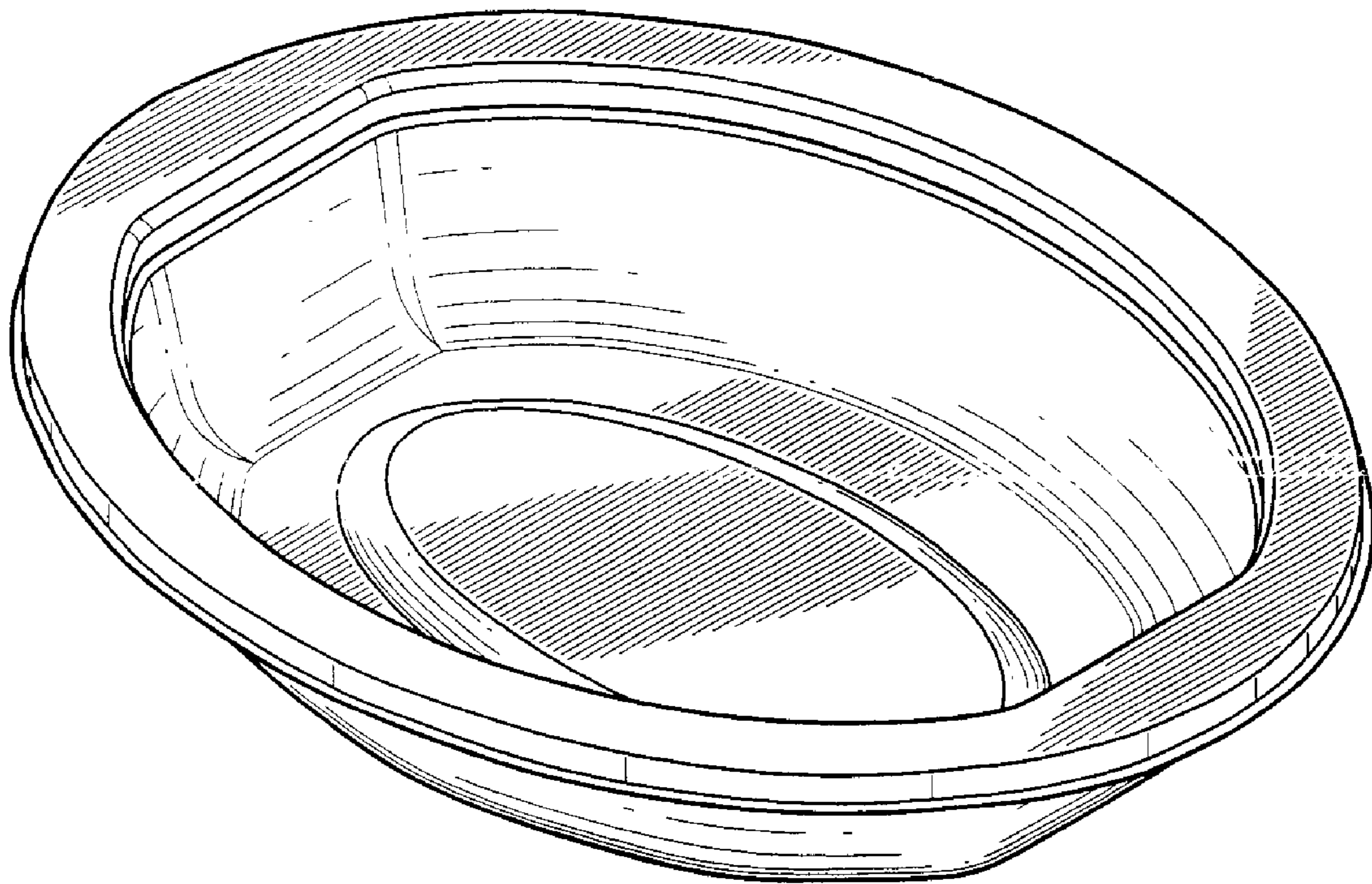

FIG. 1

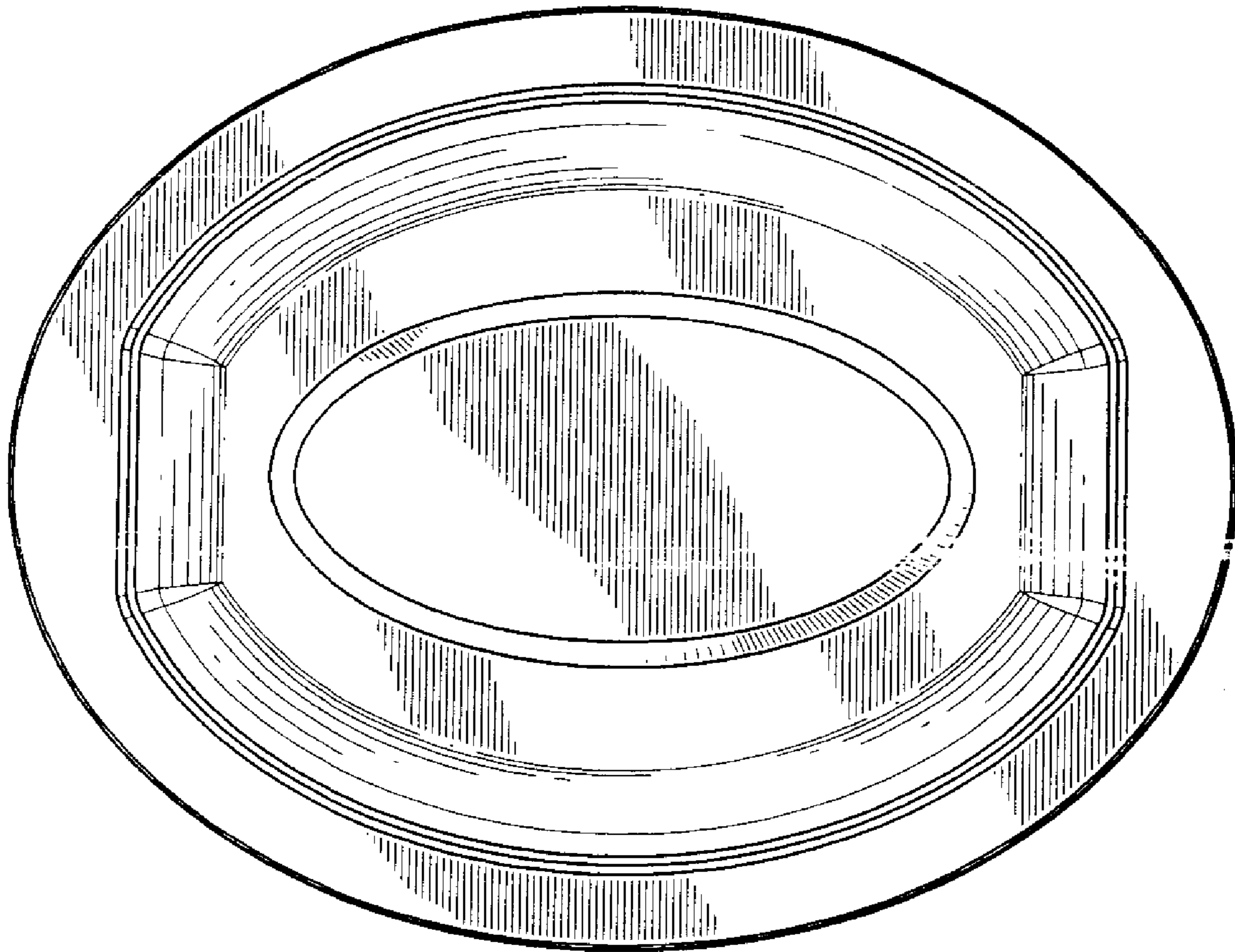

FIG. 2

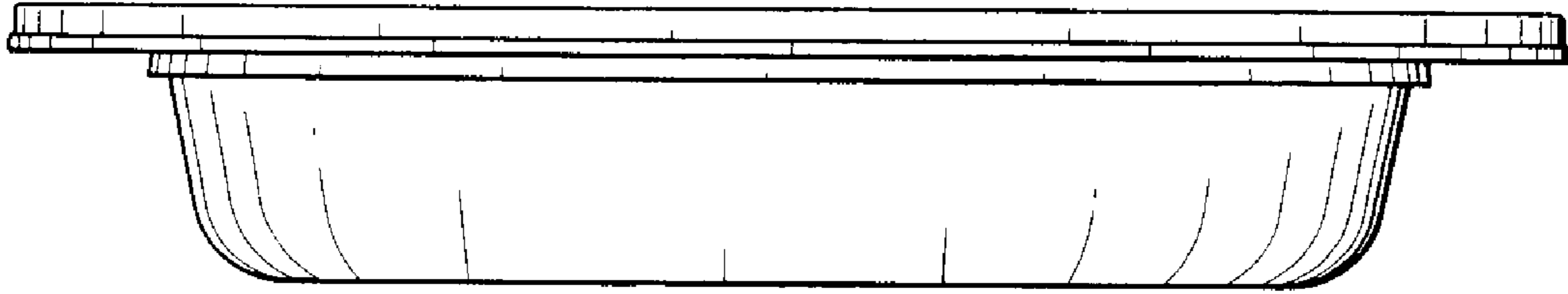

FIG. 3



FIG. 4

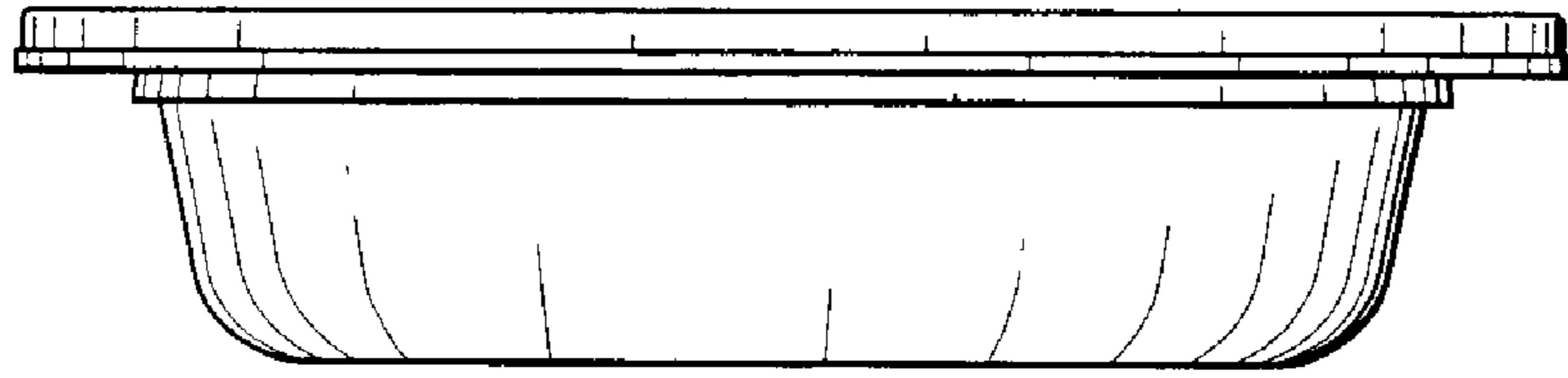

FIG. 5

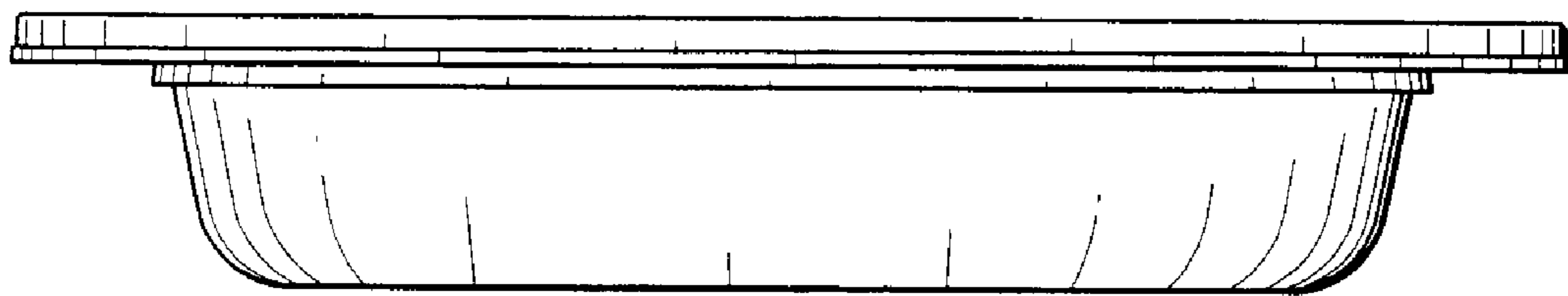

FIG. 6

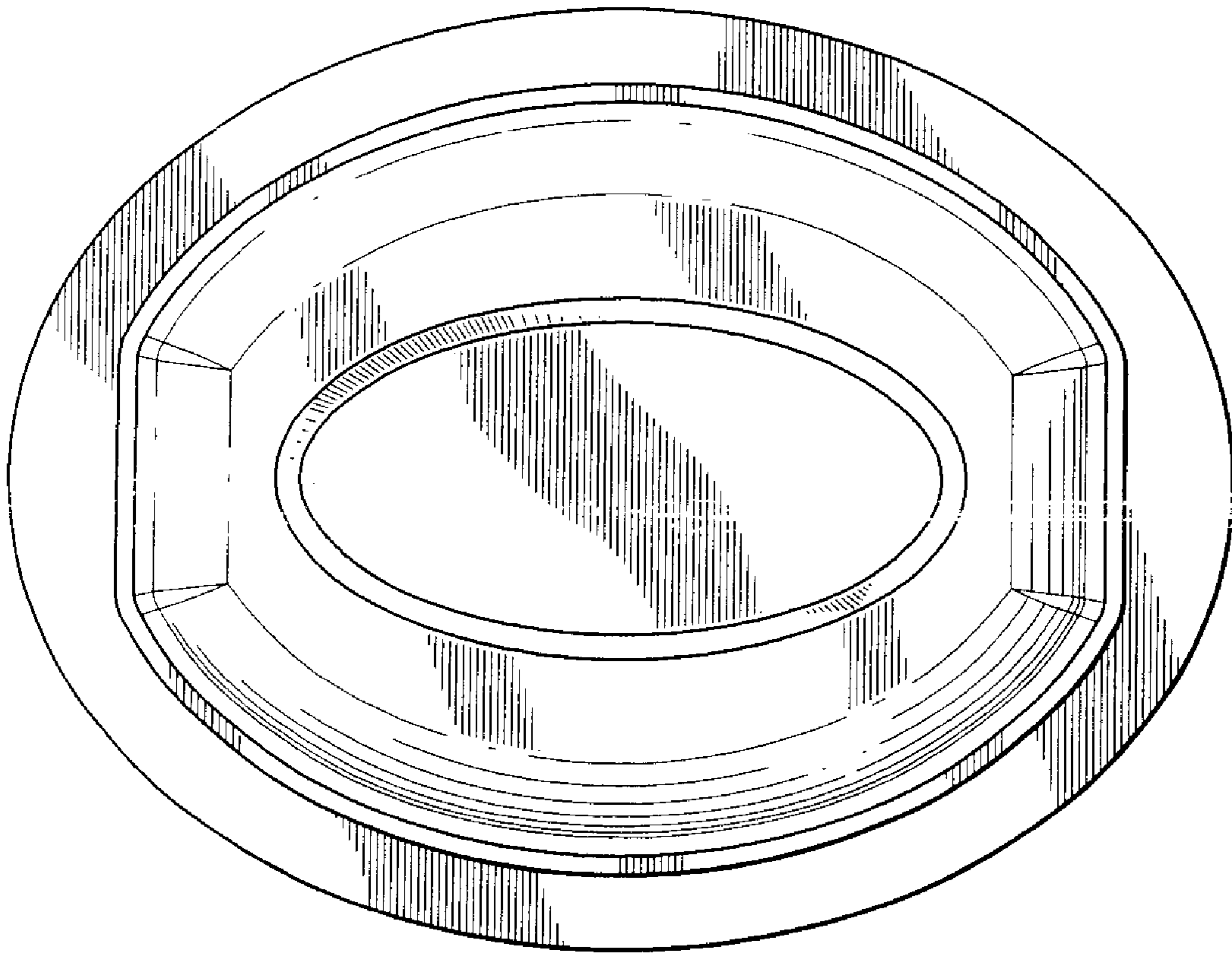

FIG. 7