



US00D529792S

(12) **United States Design Patent**
Klein et al.

(10) **Patent No.:** **US D529,792 S**
(45) **Date of Patent:** **** Oct. 10, 2006**

(54) **HANGER BRACKET FOR HANGING SHOE RACKS**

(75) Inventors: **Richard B. Klein**, Overland Park, KS (US); **John W. Scott**, Lenexa, KS (US); **Chris Serslev**, Leawood, KS (US)

(73) Assignee: **Lynk, Inc.**, Lenexa, KS (US)

(**) Term: **14 Years**

(21) Appl. No.: **29/212,588**

(22) Filed: **Sep. 3, 2004**

(51) **LOC (8) Cl.** **08-05**

(52) **U.S. Cl.** **D8/373**

(58) **Field of Classification Search** D8/349,
D8/354, 363, 373; 248/300, 200
See application file for complete search history.

(56) **References Cited**

U.S. PATENT DOCUMENTS

1,552,204 A	9/1925	Bowers	
2,459,909 A	1/1949	Alofs	
3,918,670 A	11/1975	Doherty	
D287,550 S	1/1987	Tocci	
D288,282 S	2/1987	Sheets	
D289,972 S	* 5/1987	Fogelman D8/371
D305,299 S	1/1990	Freeman	
5,085,389 A	2/1992	Levesque	
D354,412 S	1/1995	Emery	
5,511,750 A	4/1996	Evenson	
D381,225 S	7/1997	Malik	

D385,481 S	* 10/1997	Klein et al. D8/373
D386,668 S	11/1997	Klein et al.	
D397,565 S	9/1998	Klein et al.	
5,855,279 A	1/1999	Klein et al.	
D415,950 S	11/1999	Anderson	
D432,901 S	* 10/2000	McDonald D8/354
6,152,313 A	11/2000	Klein et al.	
D436,310 S	* 1/2001	Arnold D8/354
D442,471 S	* 5/2001	Willett D8/354
D468,998 S	* 1/2003	Zadak D8/373
6,505,801 B1	* 1/2003	Zerres 248/300
D489,598 S	* 5/2004	Balaban D8/354

* cited by examiner

Primary Examiner—Holly Baynham

(74) *Attorney, Agent, or Firm*—Blackwell Sanders Peper Martin, LLP

(57) **CLAIM**

The ornamental design for a hanger bracket for hanging shoe racks, as shown and described.

DESCRIPTION

FIG. 1 is a front perspective view of a hanger bracket for hanging shoe racks showing our new design; FIG. 2 is a left side elevational view thereof, the right side appearing as a mirror image; FIG. 3 is a rear elevational view thereof; FIG. 4 is a front elevational view thereof; FIG. 5 is a bottom plan view thereof; and, FIG. 6 is a top plan view thereof.

1 Claim, 2 Drawing Sheets

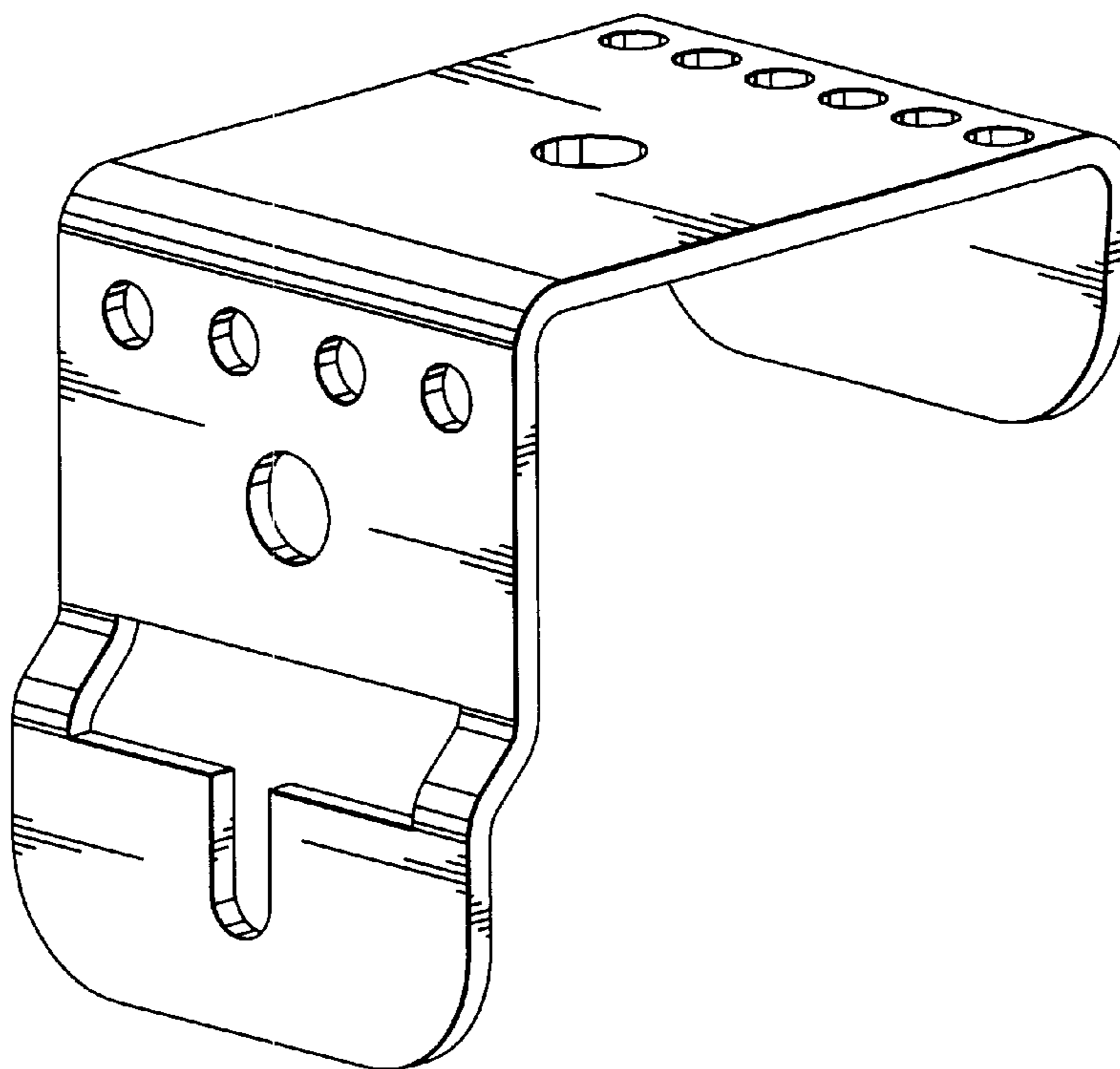

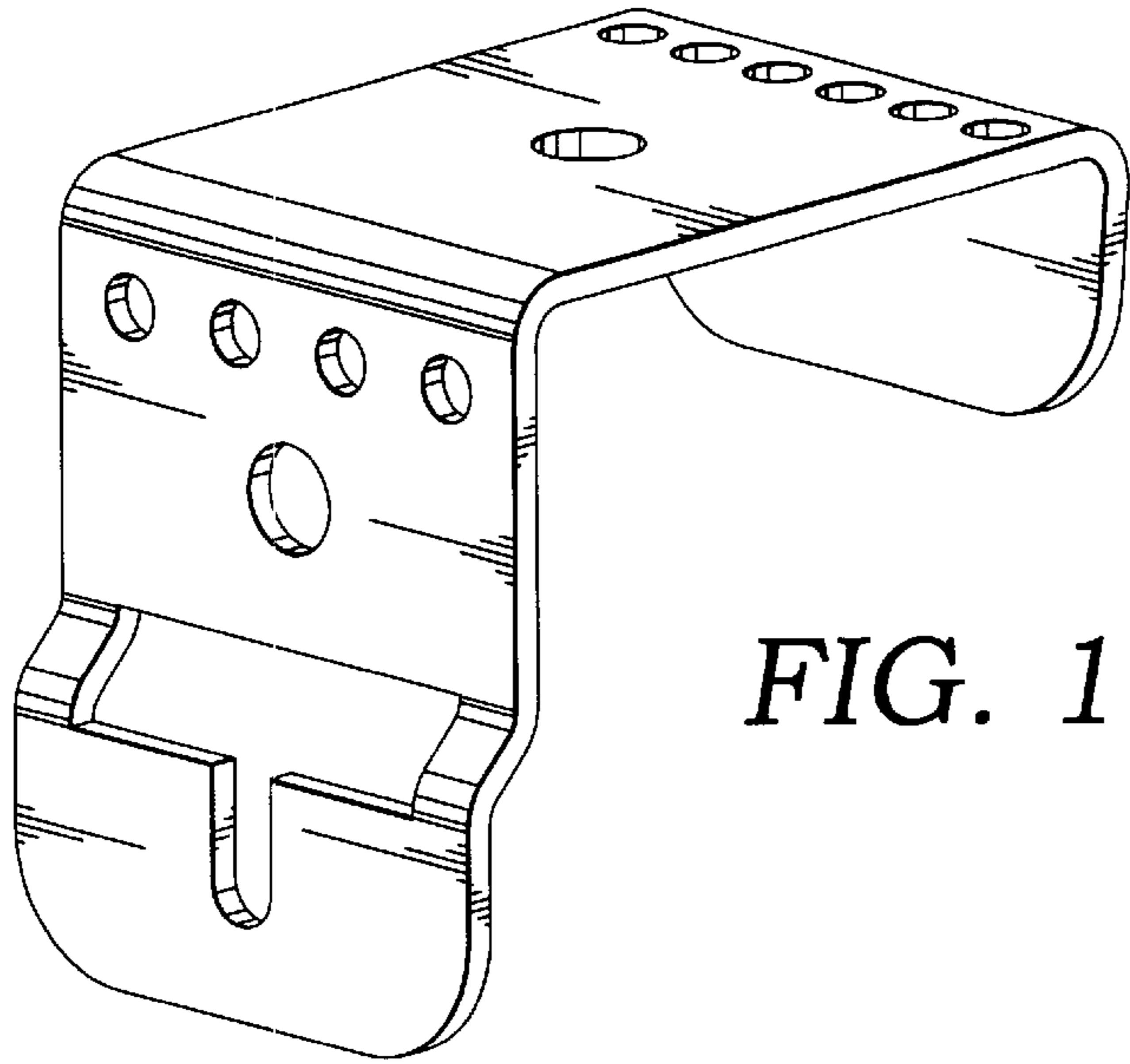

FIG. 1.

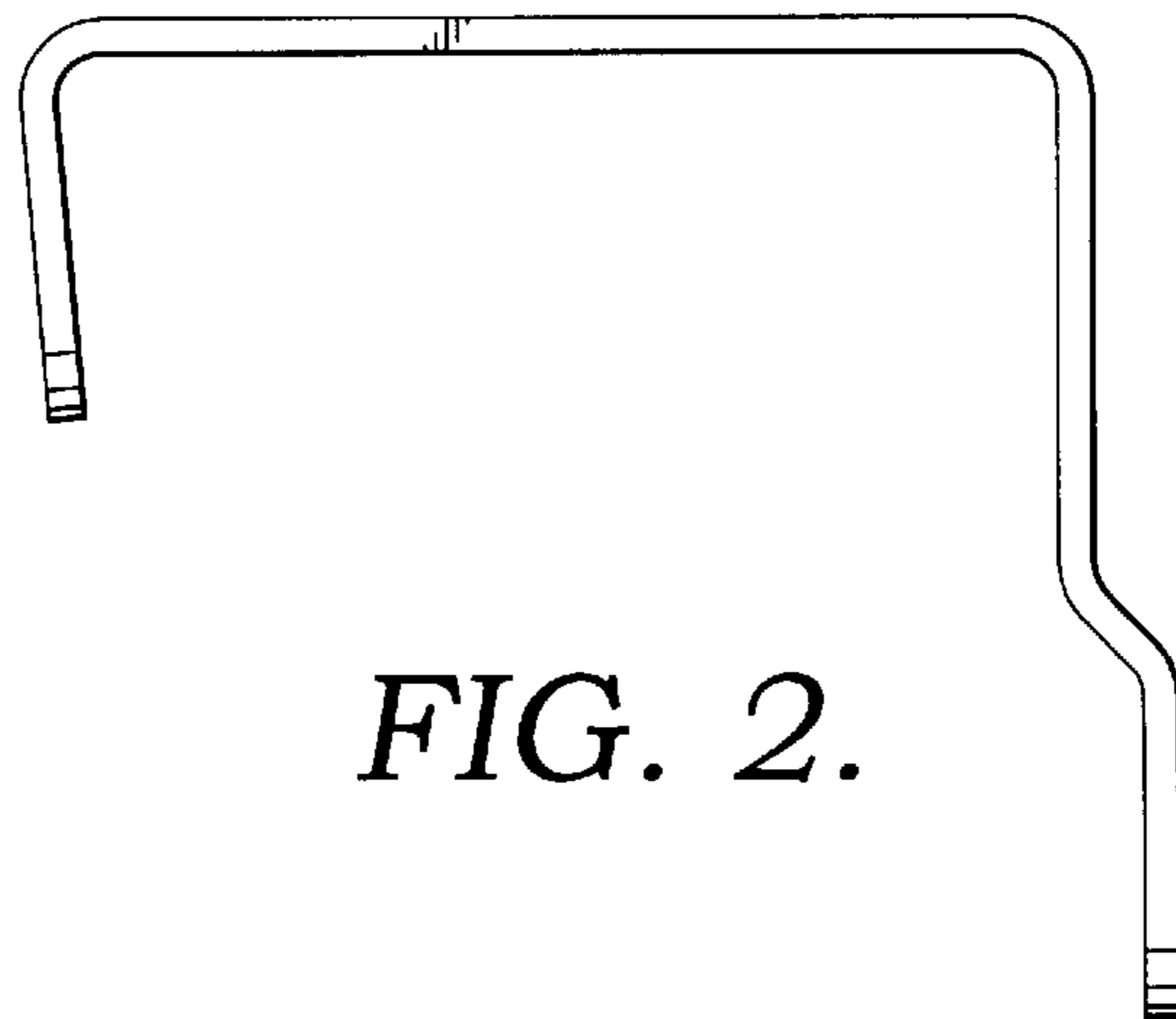

FIG. 2.

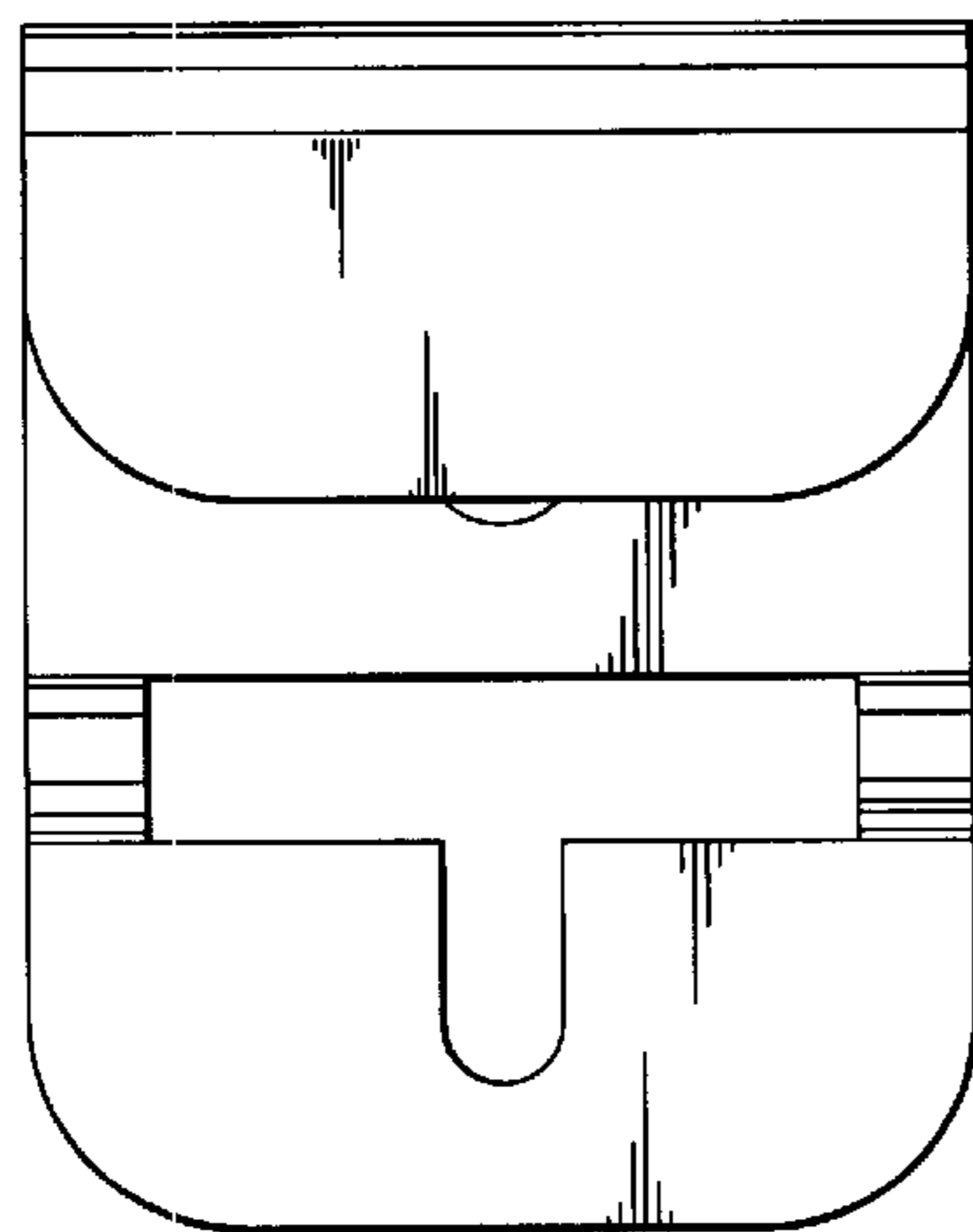

FIG. 3.

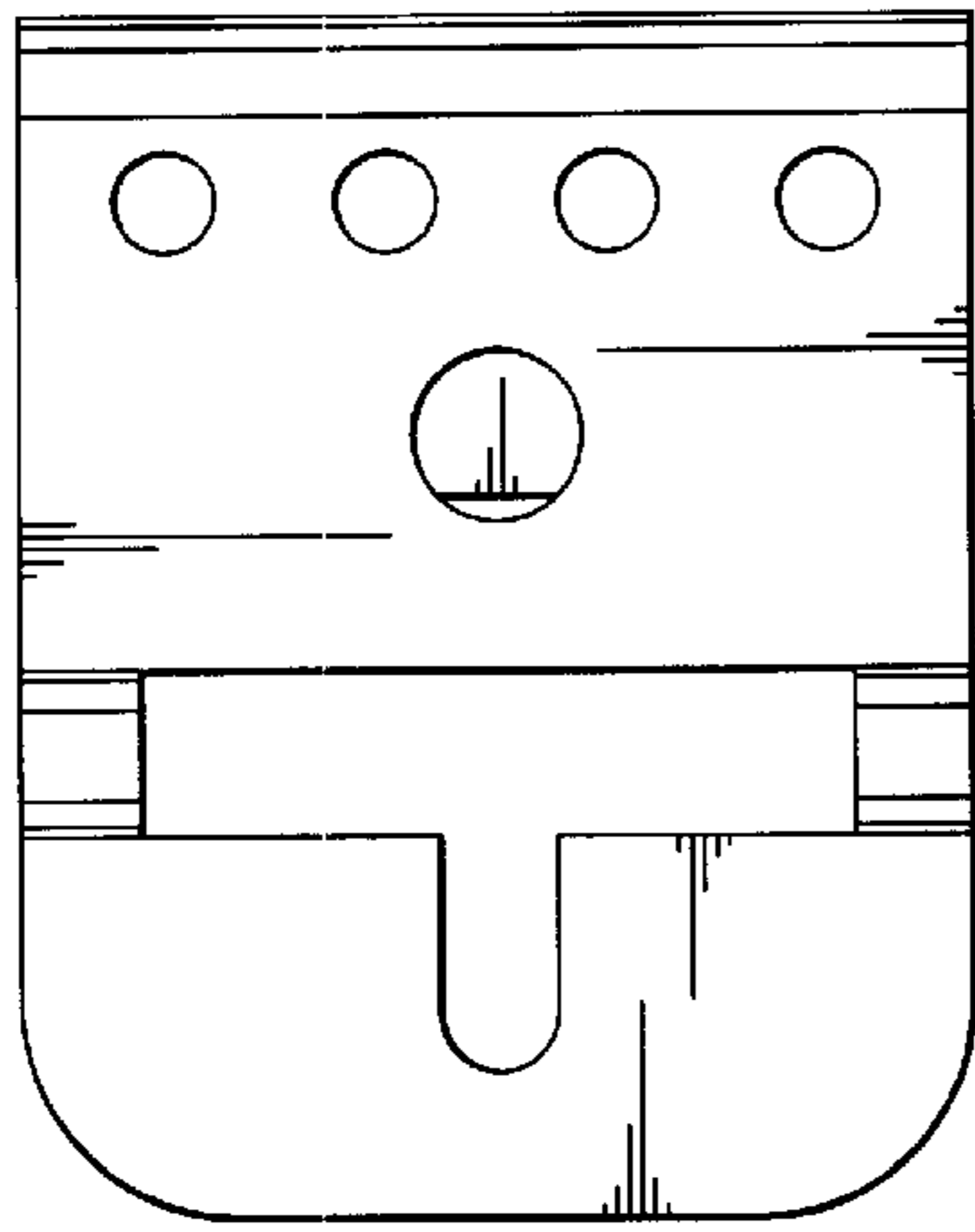

FIG. 4.

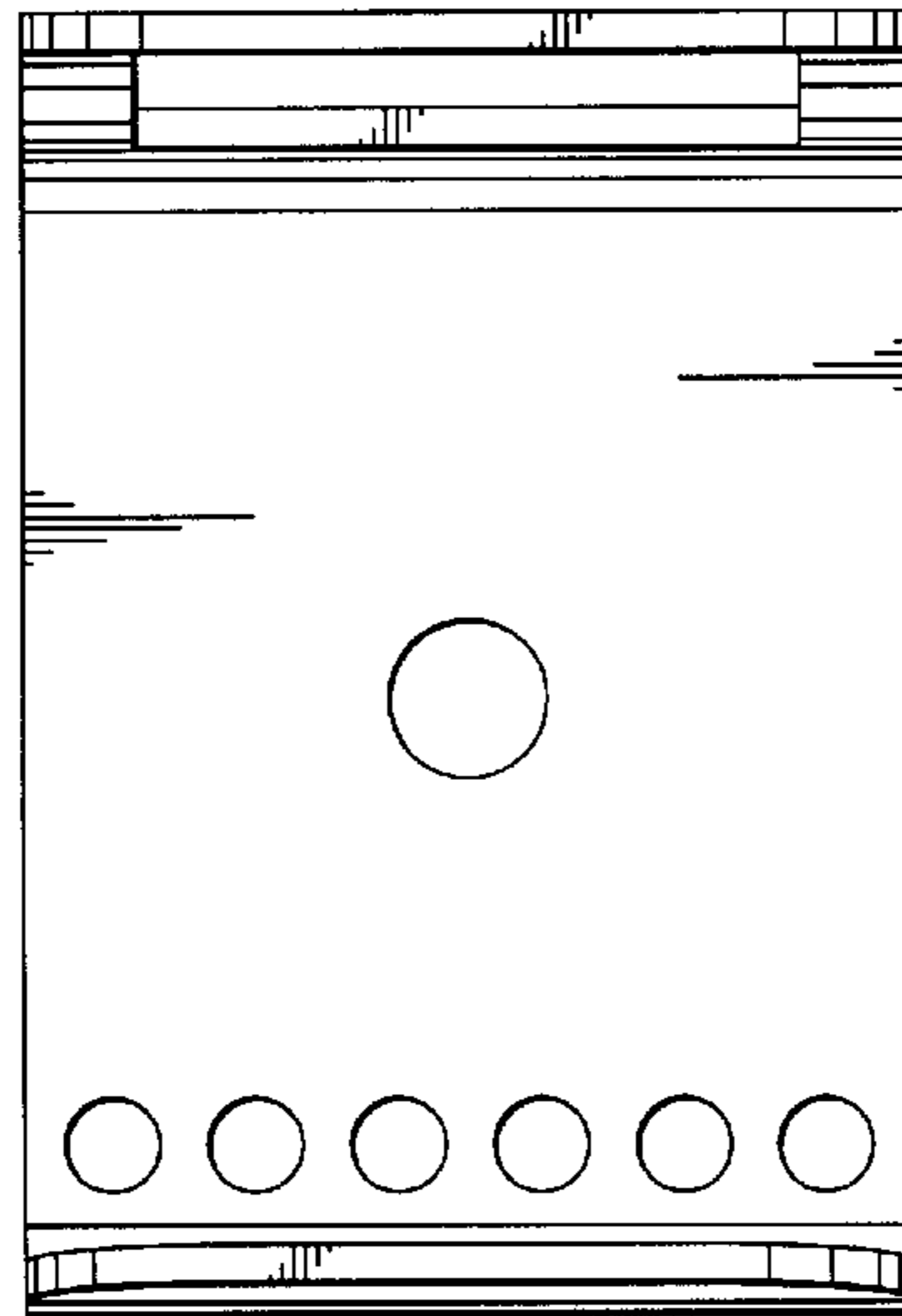

FIG. 5.

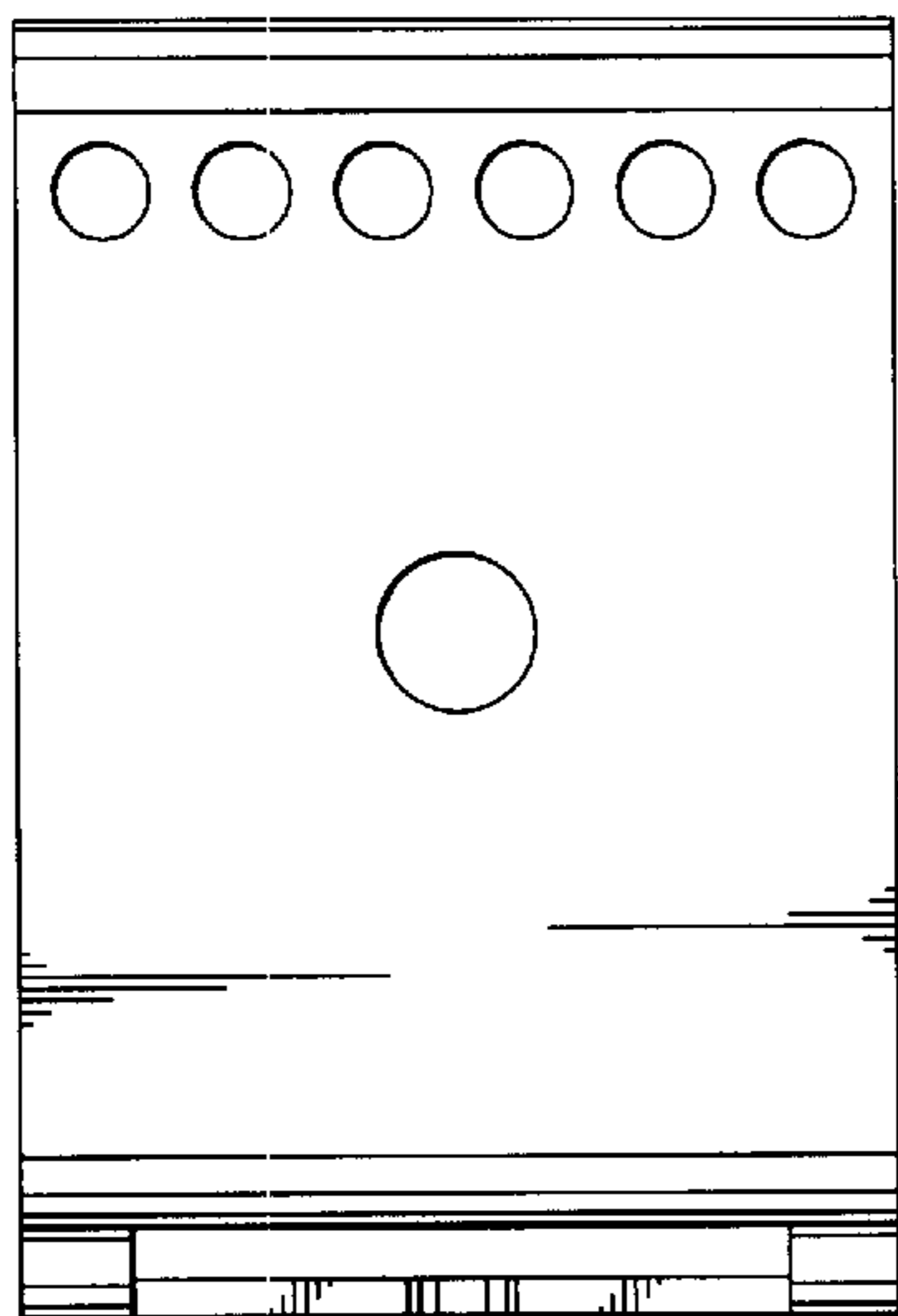

FIG. 6.