

US00D529492S

(12) **United States Design Patent**
Hino et al.

(10) **Patent No.:** **US D529,492 S**
(45) **Date of Patent:** **** Oct. 3, 2006**

(54) **ARITHMETIC AND CONTROL UNIT**

(75) Inventors: **Mariko Hino**, Tokyo (JP); **Naoya Matsui**, Tokyo (JP)

(73) Assignee: **Sony Computer Entertainment, Inc.**, Tokyo (JP)

(**) Term: **14 Years**

(21) Appl. No.: **29/224,857**

(22) Filed: **Mar. 9, 2005**

(30) **Foreign Application Priority Data**

Oct. 13, 2004 (JP) D2004-031032

(51) **LOC (8) Cl.** **14-02**

(52) **U.S. Cl.** **D14/348**

(58) **Field of Classification Search** D14/125,
D14/135-7, 239-40, 242-3, 156, 167, 256,
D14/299, 301, 348-9, 351-4, 356-8, 361,
D14/363, 366-368, 433-434, 385, 300, 313,
D14/341, 344, 347, 100; D21/324, 329, 333;
361/679, 685-6; 711/100

See application file for complete search history.

(56) **References Cited**

U.S. PATENT DOCUMENTS

- D284,664 S * 7/1986 Davis et al. D14/354
- D305,753 S * 1/1990 Hoshino D14/351
- D322,065 S * 12/1991 Ziebarth D14/129
- D335,489 S * 5/1993 Sander D14/352
- 5,248,193 A * 9/1993 Schlemmer 312/223.2
- D360,406 S * 7/1995 Hill et al. D14/351
- 5,732,000 A * 3/1998 Chiesi et al. 361/679
- D423,500 S 4/2000 Miyazaki
- D433,681 S * 11/2000 Jean et al. D14/349
- D447,139 S * 8/2001 Mache et al. D14/351

- D467,928 S 12/2002 Chen et al.
- 6,549,397 B1 * 4/2003 Diaz et al. 361/683
- 6,661,652 B1 * 12/2003 Worden et al. 361/685
- D485,275 S 1/2004 Chen et al.
- 6,724,619 B1 * 4/2004 Kwong et al. 361/685
- 6,807,052 B1 * 10/2004 Erickson et al. 361/683

FOREIGN PATENT DOCUMENTS

- GB 2076698 A 11/1998
- GB D2084226 S 5/2000
- GB 2091821 A 11/2000
- GB D3009764 S 2/2003
- GB D3009765 S 2/2003
- GB D3009766 S 2/2003
- GB D3006371 S 3/2003

* cited by examiner

Primary Examiner—Robin Webster

Assistant Examiner—Karen E. Patterson

(74) *Attorney, Agent, or Firm*—Rader, Fishman & Grauer PLLC

(57) **CLAIM**

The ornamental design for an arithmetic and control unit, as shown.

DESCRIPTION

FIG. 1 is a front elevational view of a an arithmetic and control unit showing our new design; FIG. 2 is a rear elevational view thereof; FIG. 3 is a left side elevational view thereof; FIG. 4 is a right side elevational view thereof; FIG. 5 is a top plan view thereof; FIG. 6 is a bottom plan view thereof; FIG. 7 is a front left top perspective view thereof; and, FIG. 8 is a rear right top perspective view thereof.

1 Claim, 8 Drawing Sheets

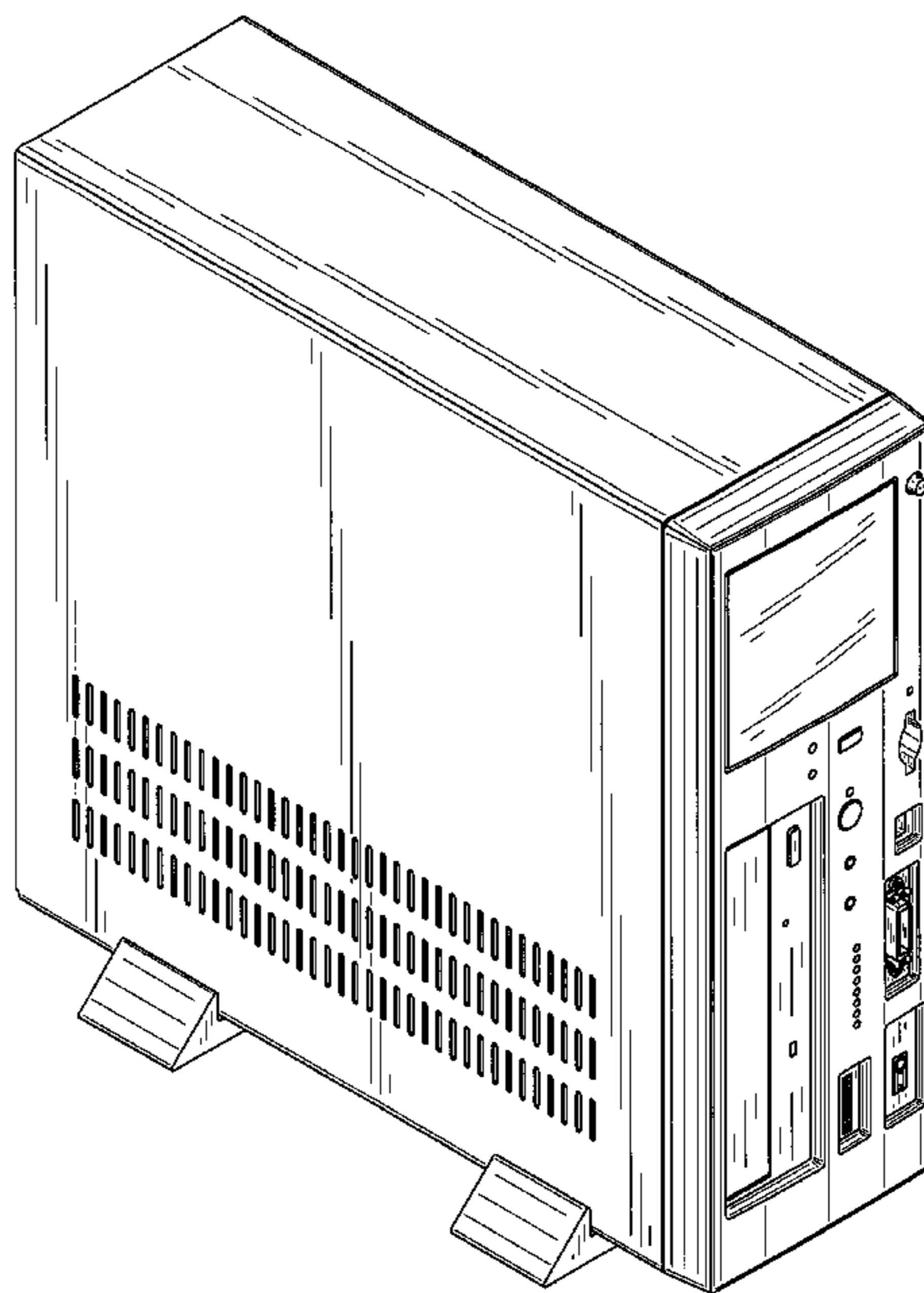

FIG. 1

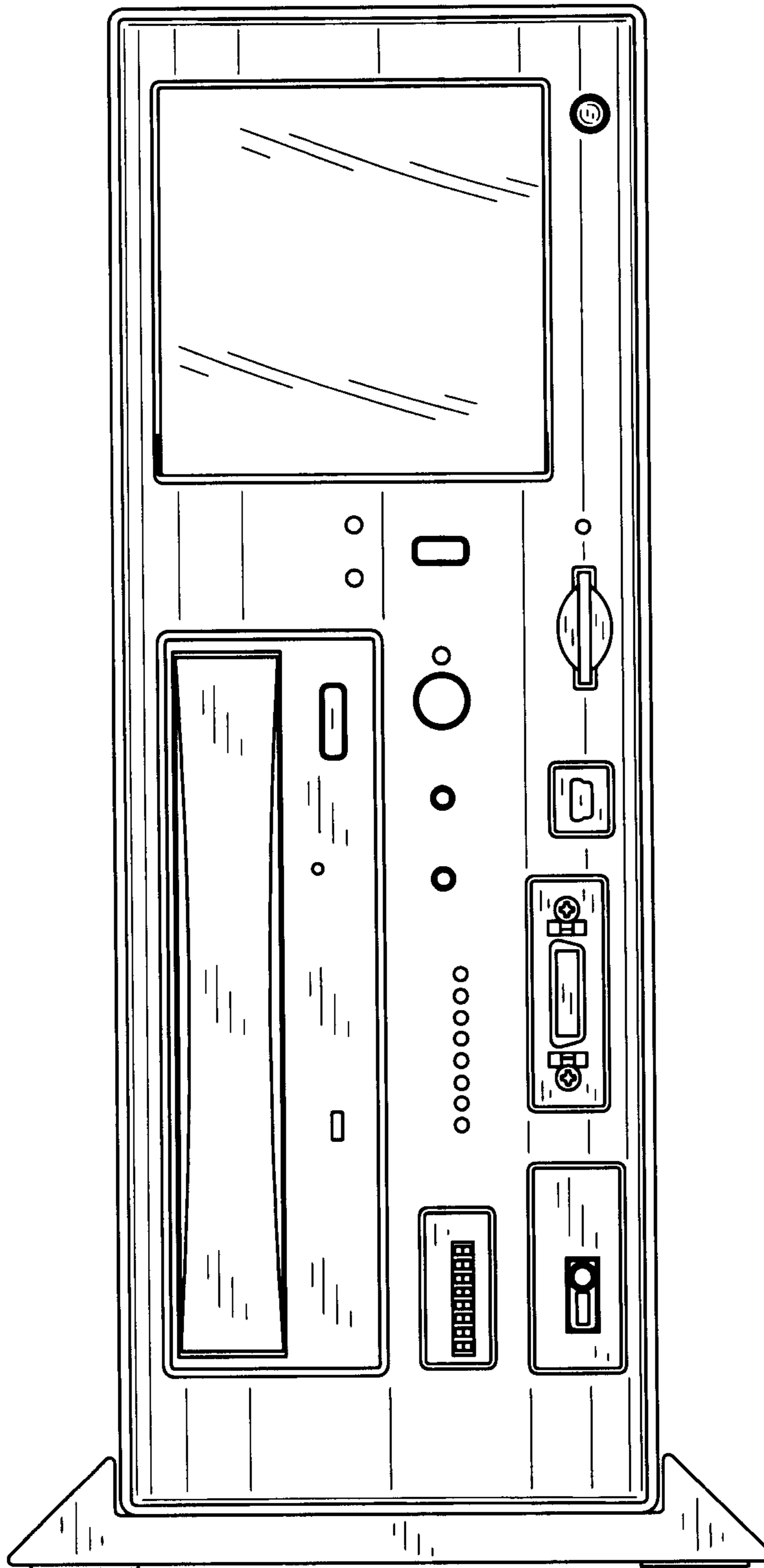
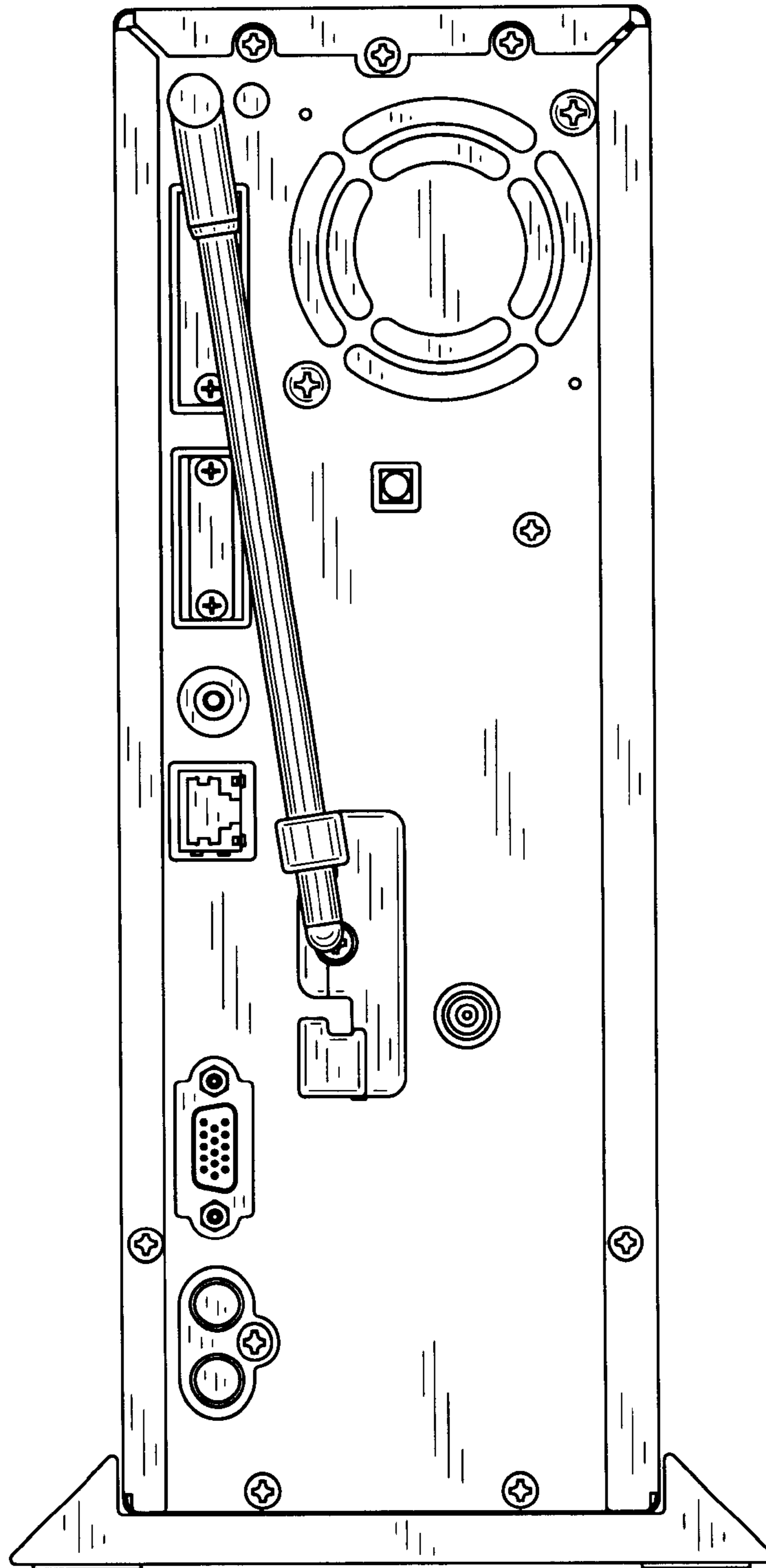

FIG.2



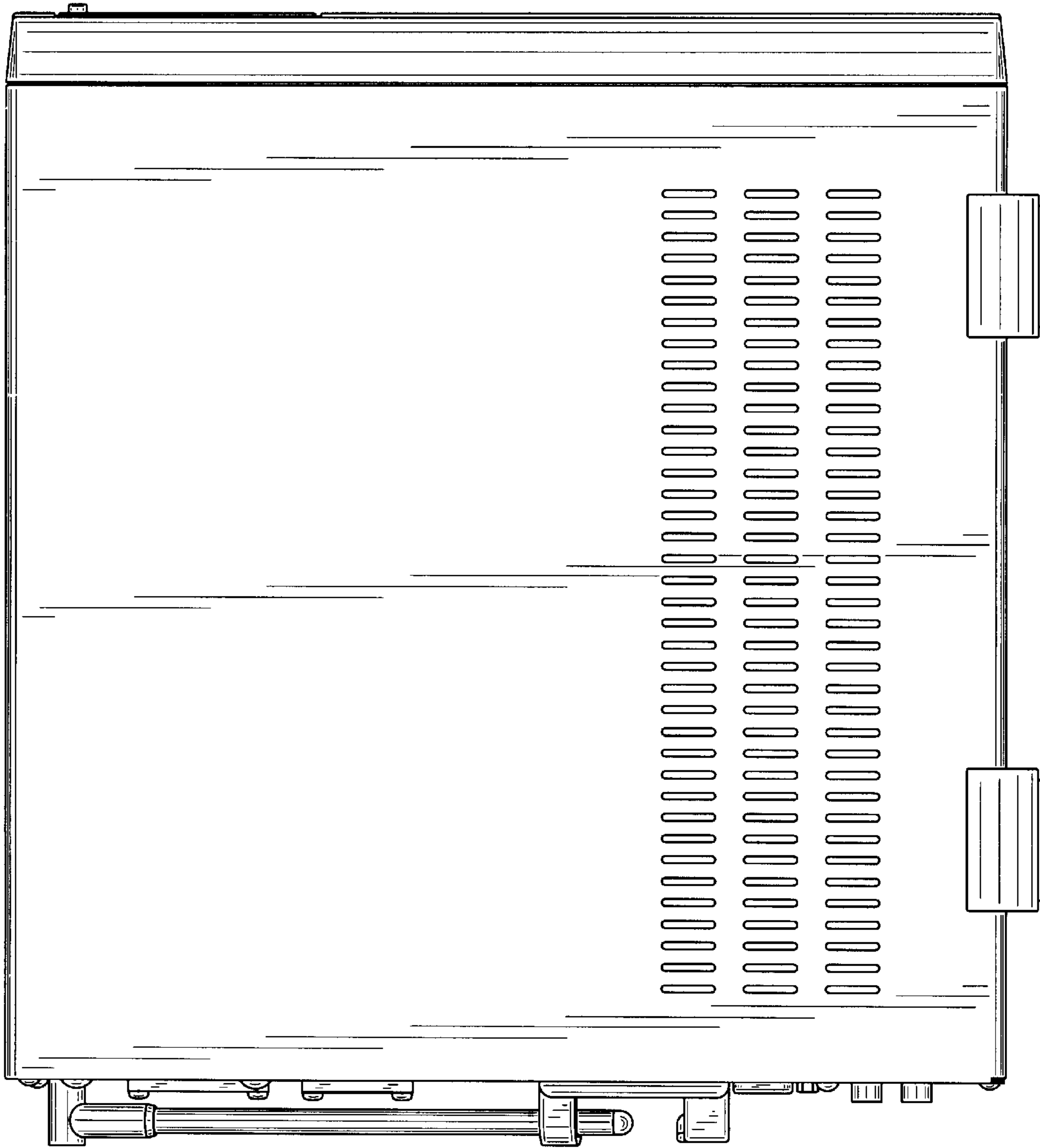

FIG.3

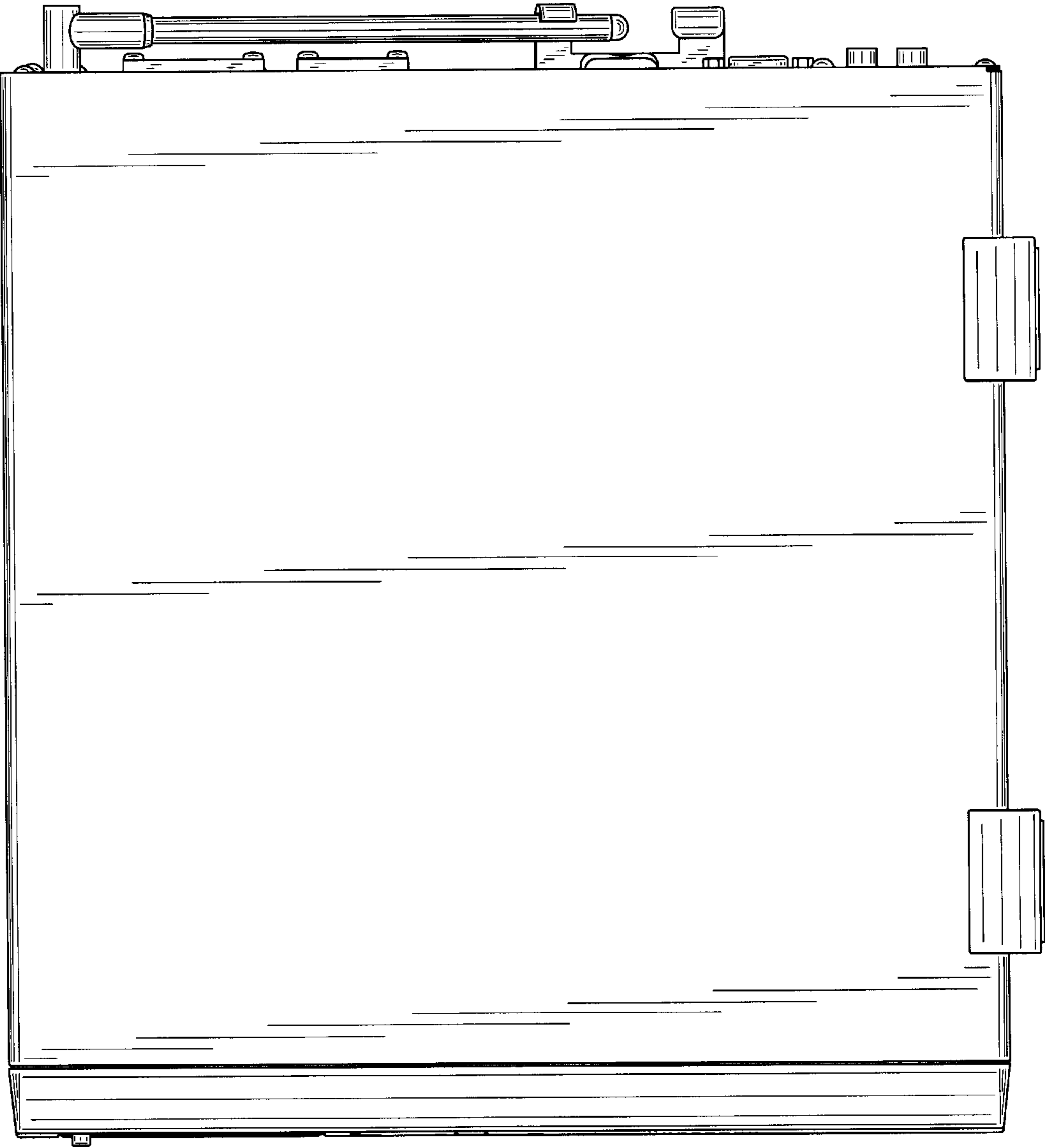

FIG.4

FIG.5

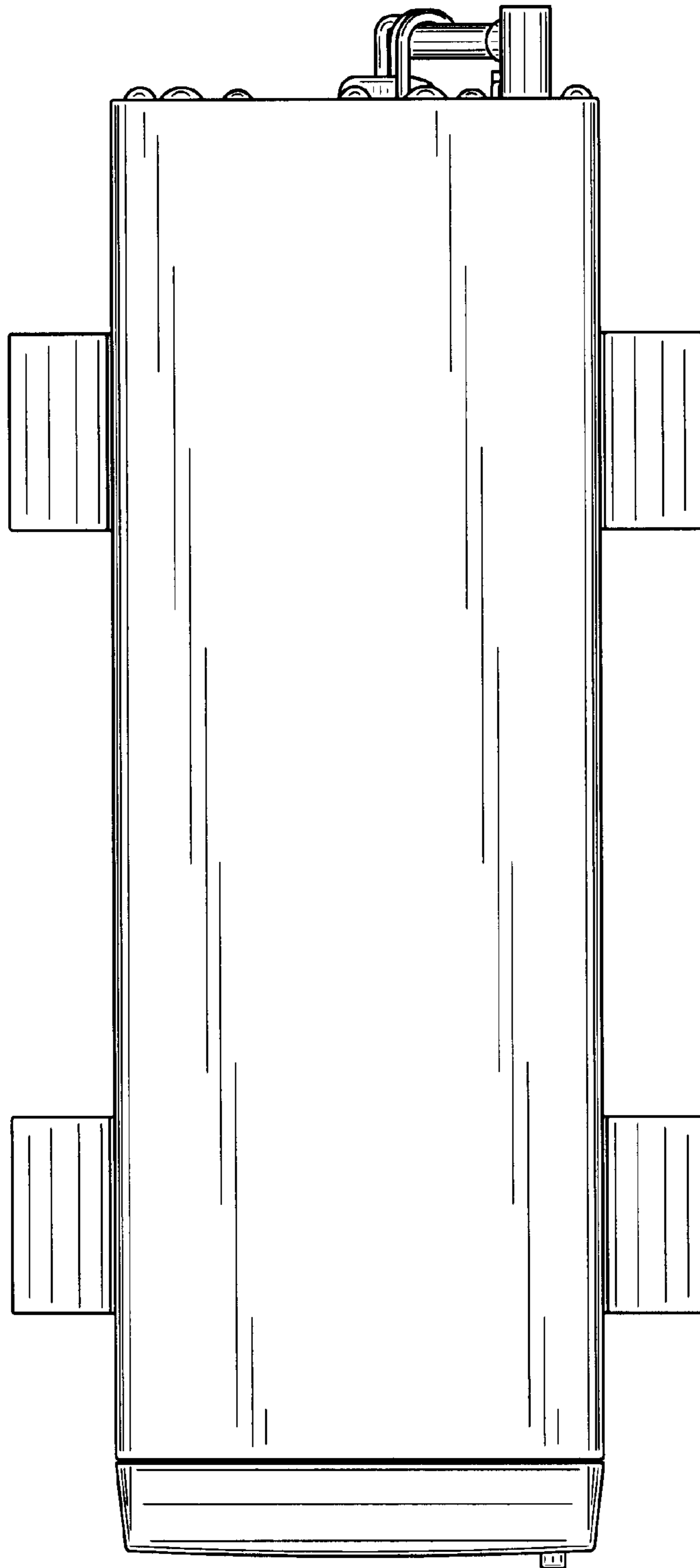

FIG.6

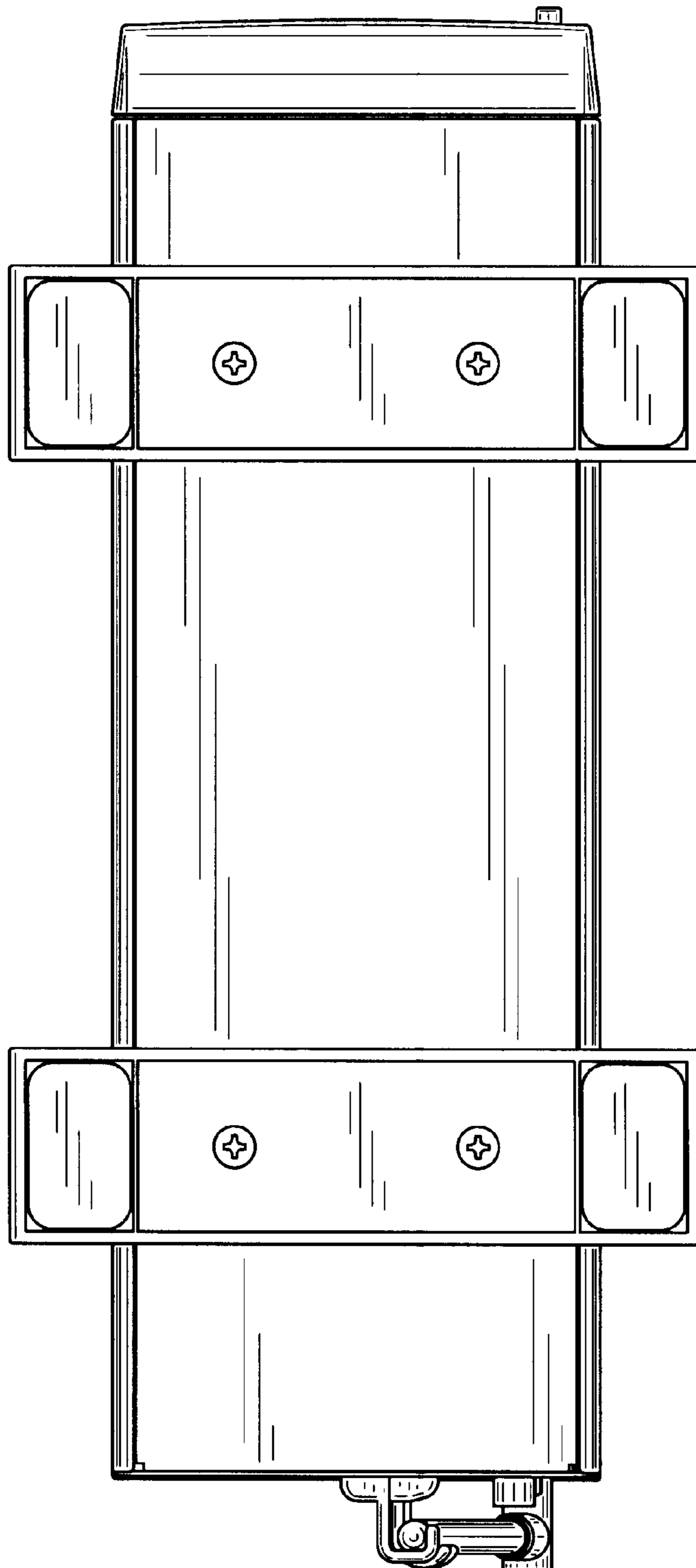

FIG.7

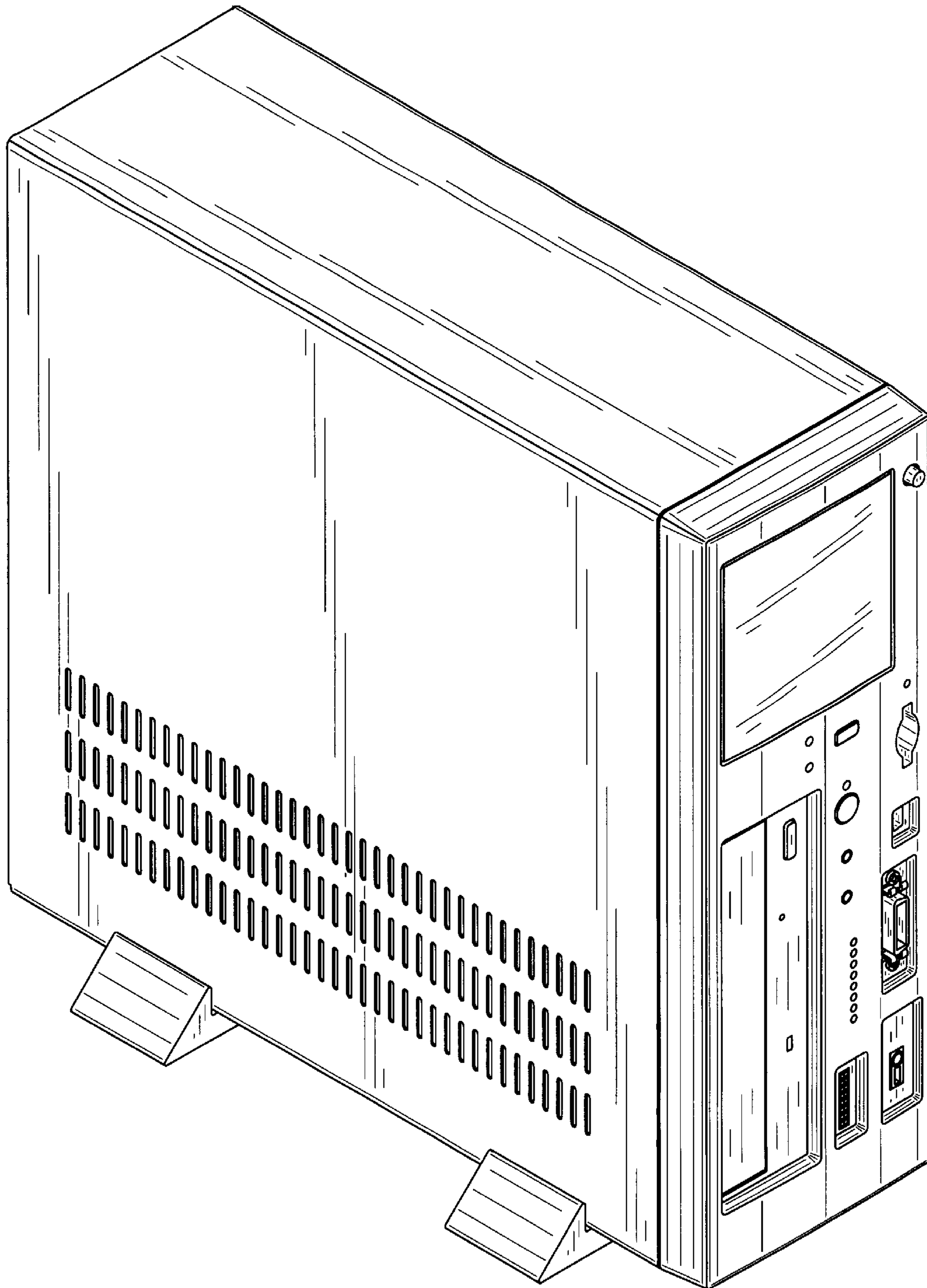

FIG.8

