



US00D529463S

(12) **United States Design Patent**  
**Khadivar**

(10) **Patent No.:** **US D529,463 S**

(45) **Date of Patent:** **\*\* Oct. 3, 2006**

(54) **DIGITAL VIDEO DISK PLAYER**

(76) Inventor: **Michael Khadivar**, 5151 N. Shore,  
Lincolnwood, IL (US) 60646

(\*\*) Term: **14 Years**

(21) Appl. No.: **29/208,890**

(22) Filed: **Jul. 1, 2004**

**Related U.S. Application Data**

(63) Continuation-in-part of application No. 29/169,368, filed on  
Oct. 18, 2002, now abandoned.

(51) **LOC (8) Cl.** ..... **14-01**

(52) **U.S. Cl.** ..... **D14/136**

(58) **Field of Classification Search** ..... D14/135-136,  
D14/156-157, 160-165, 167-168, 192-198,  
D14/188, 217, 257, 258, 445; 360/99.02,  
360/99.07; 369/75.11, 75.21, 77.21, 77.11;  
720/612, 619, 647, 655; 455/344, 347-351  
See application file for complete search history.

(56) **References Cited**

**U.S. PATENT DOCUMENTS**

4,561,085	A	*	12/1985	Funabashi	.....	369/77.1
D308,868	S	*	6/1990	Kohno	.....	D14/156
D327,270	S	*	6/1992	Metzler	.....	D14/265
D364,623	S		11/1995	Khadivar		
D365,561	S		12/1995	Khadivar		
5,898,650	A		4/1999	Porsbo et al.		
D409,607	S	*	5/1999	Shiono	.....	D14/156
D415,492	S	*	10/1999	Metzler	.....	D14/188

**OTHER PUBLICATIONS**

[http://www.p4c.philips.com/files/m/mz120037/mz130037\\_ihr\\_us.jpg](http://www.p4c.philips.com/files/m/mz120037/mz130037_ihr_us.jpg); printed Oct. 10, 2003.

[http://www.p4c.philips.com/files/a/aj3980\\_17/aj3980\\_17\\_ihr\\_us.jpg](http://www.p4c.philips.com/files/a/aj3980_17/aj3980_17_ihr_us.jpg); printed Oct. 10, 2003.

\* cited by examiner

*Primary Examiner*—Nanda Bondade

(74) *Attorney, Agent, or Firm*—Vedder Price Kaufman & Kammholz

(57) **CLAIM**

I claim the ornamental design for the digital video disk player, as shown in the accompanying figures.

**DESCRIPTION**

FIG. 1 is a perspective view of a digital video disk player showing my new design;

FIG. 2 is rear elevational view thereof;

FIG. 3 is a top plan view thereof;

FIG. 4 is a bottom plan view thereof;

FIG. 5 is a right side elevational view thereof;

FIG. 6 is a left side elevational view thereof;

FIG. 7 is a perspective view of the second embodiment of FIG. 1;

FIG. 8 is a rear elevational view thereof;

FIG. 9 is a top plan view thereof;

FIG. 10 is a bottom plan view thereof;

FIG. 11 is a right side elevational view thereof; and,

FIG. 12 is a left side elevational view thereof.

The broken line showing on the drawing disclosure is for illustrative purposes only and forms no part of the claimed design.

**1 Claim, 7 Drawing Sheets**

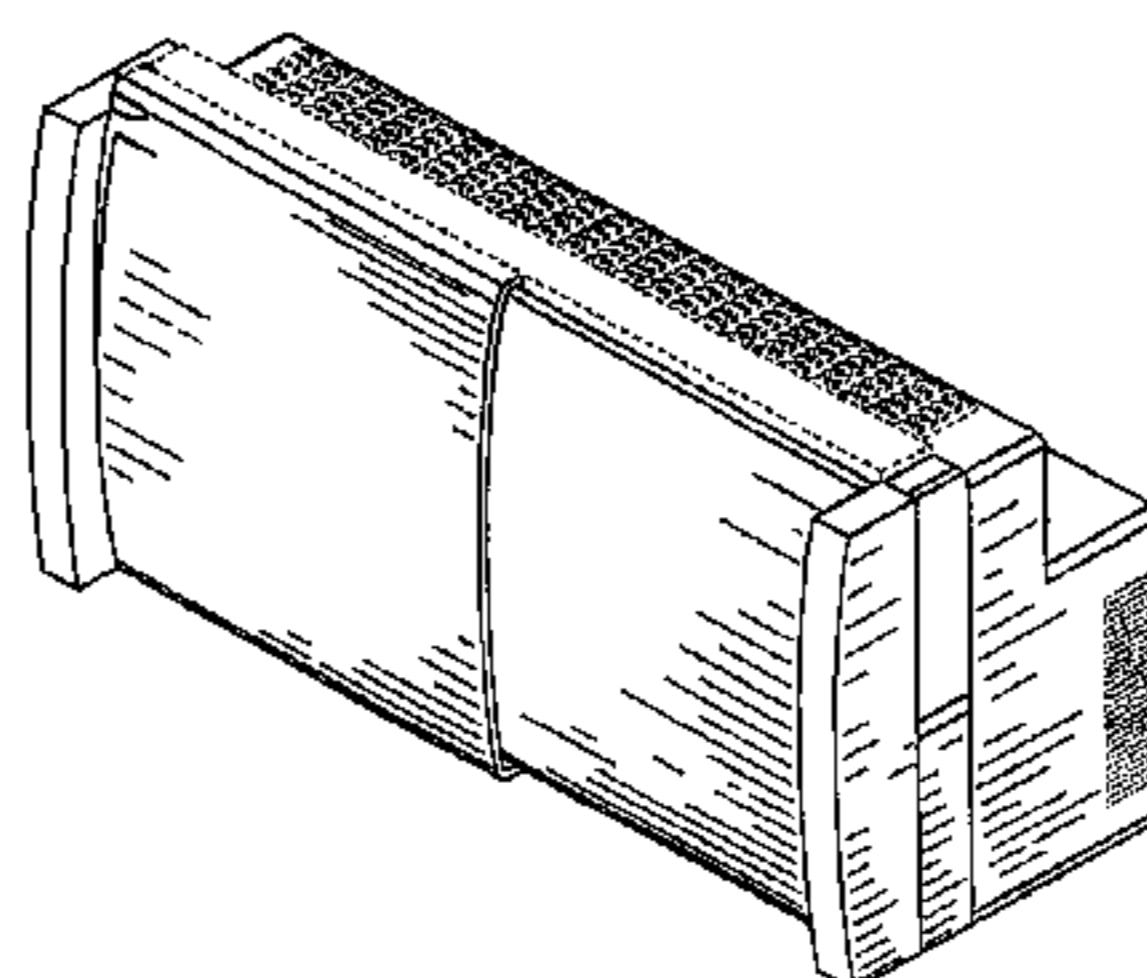
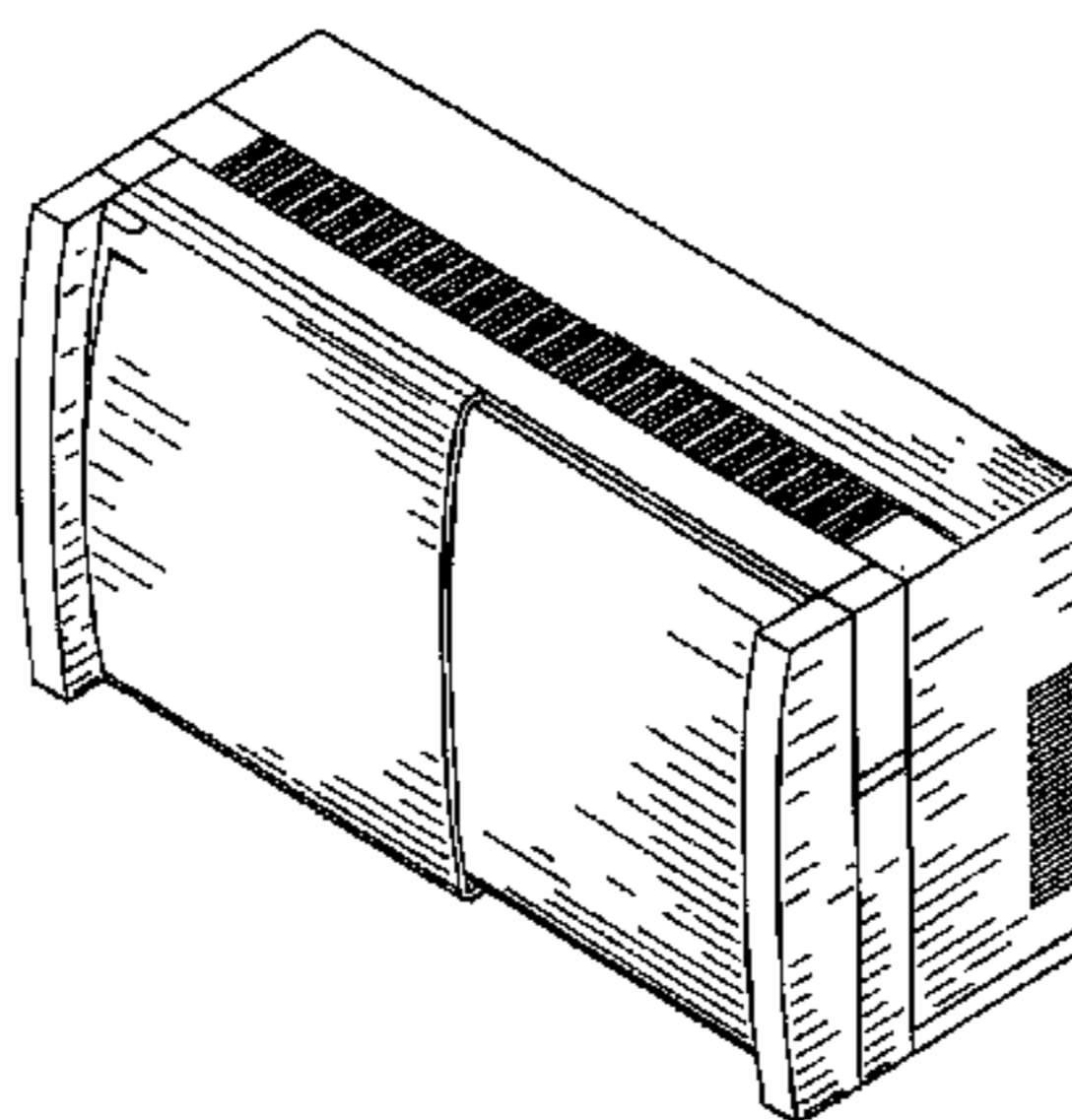

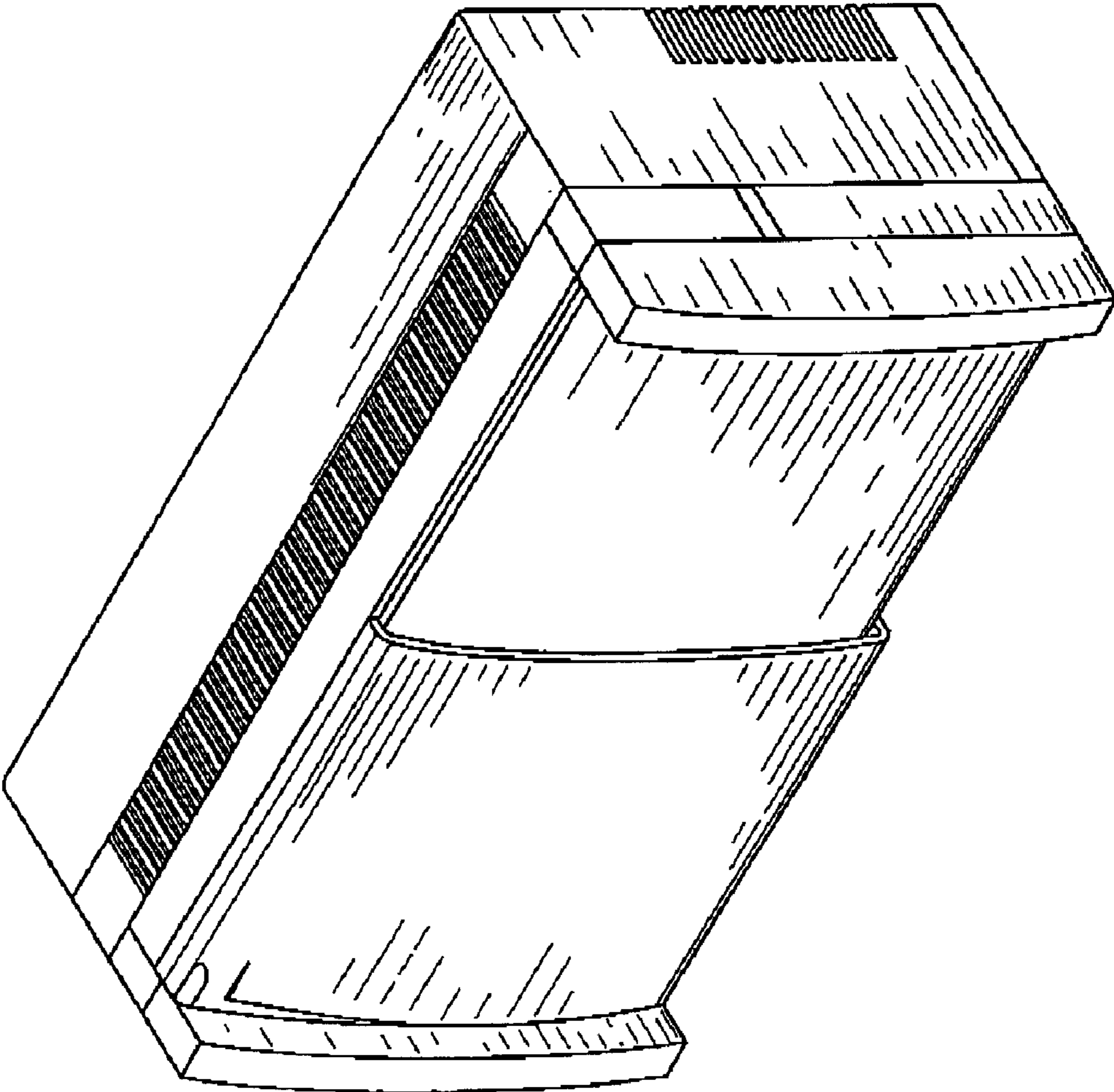

FIG. 1

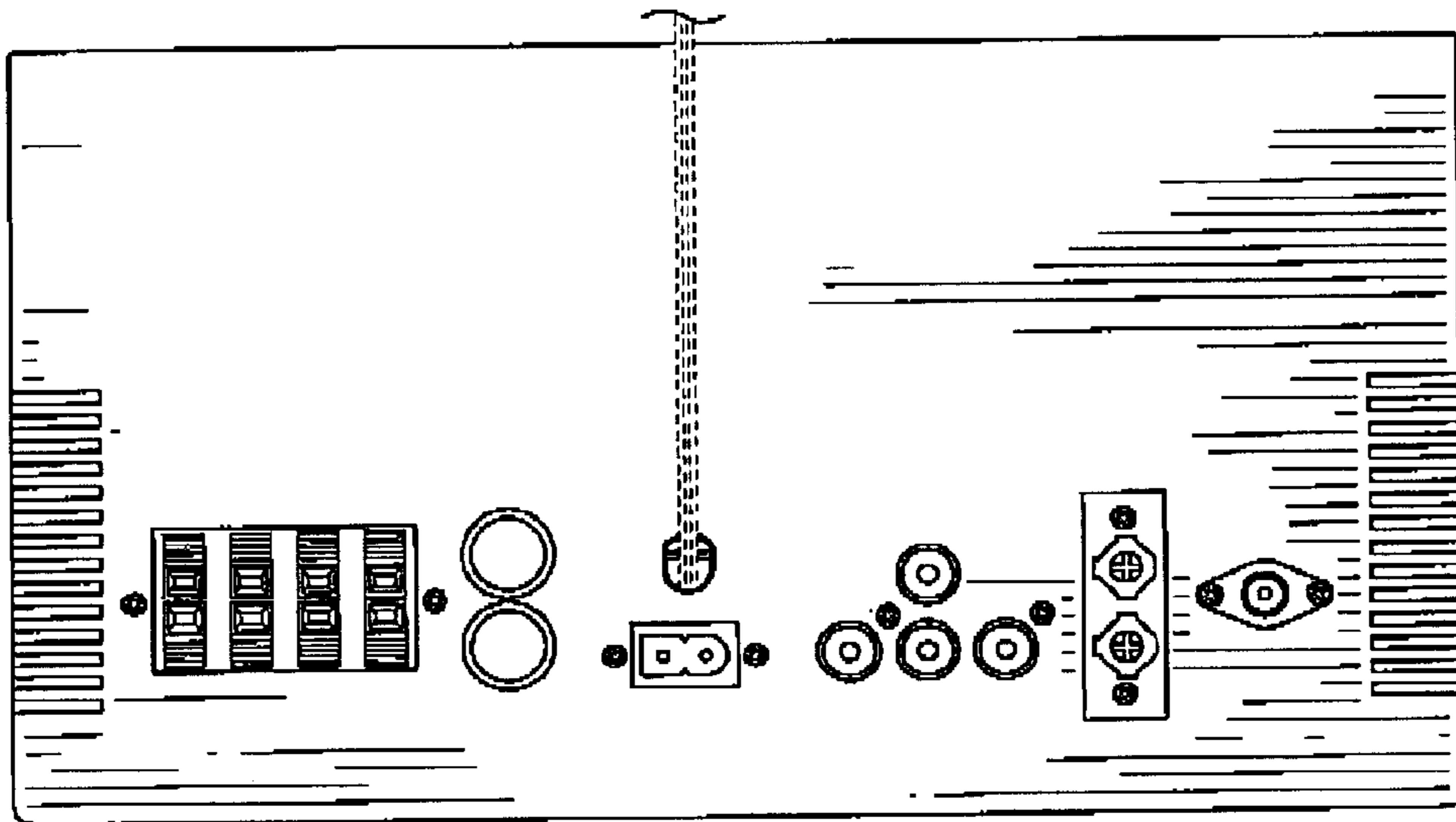

FIG. 2

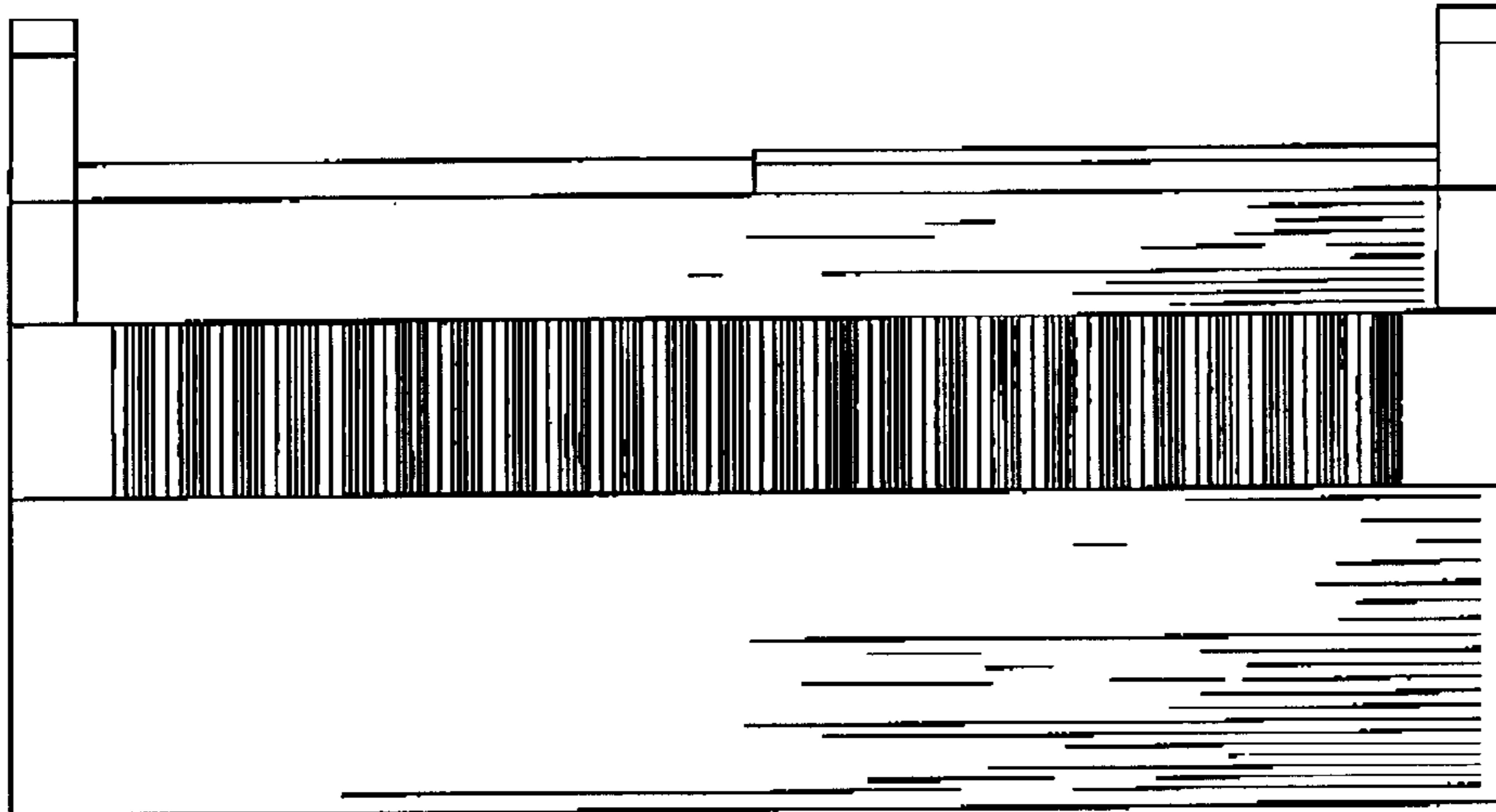

FIG. 3

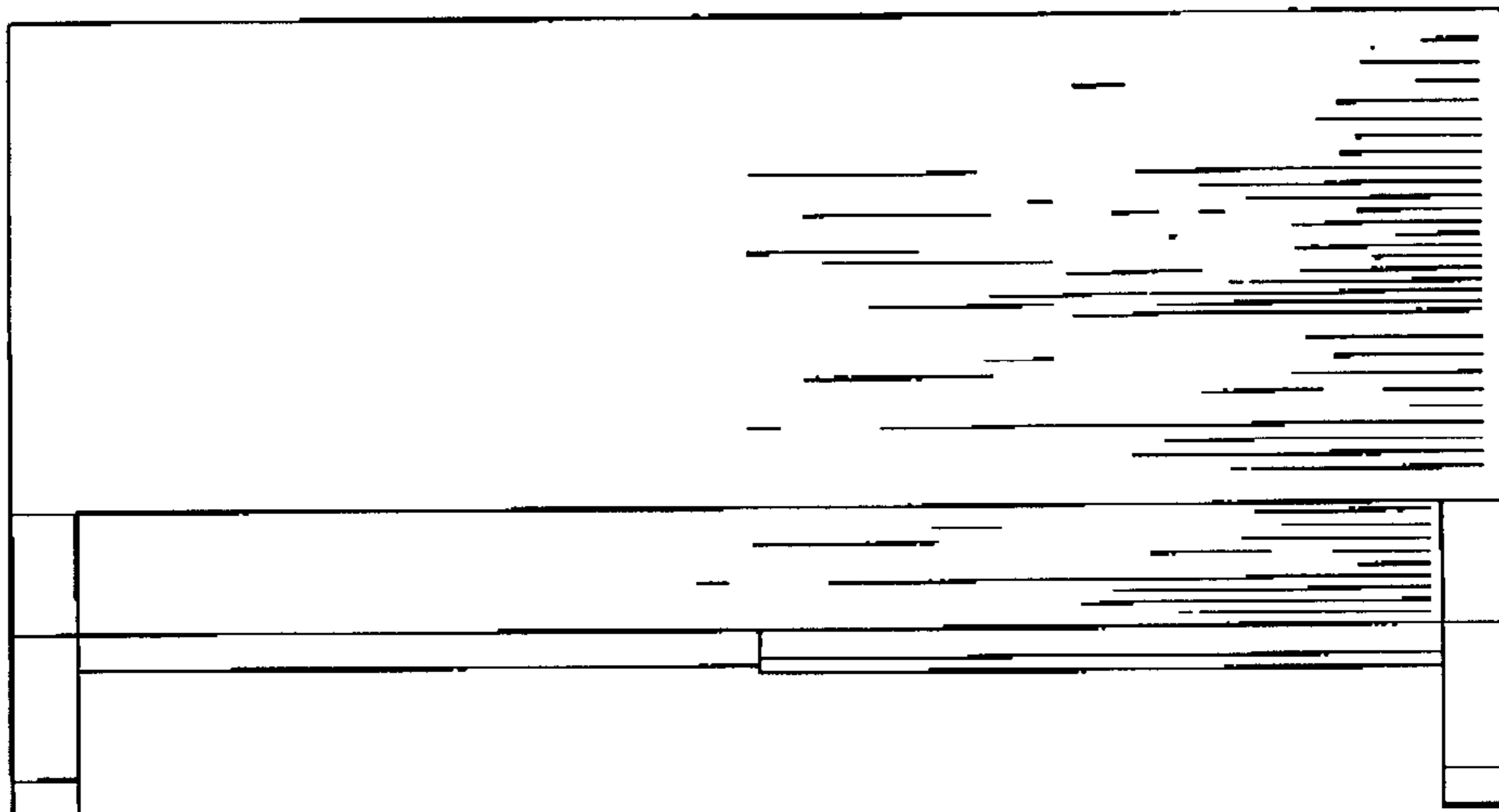

FIG. 4

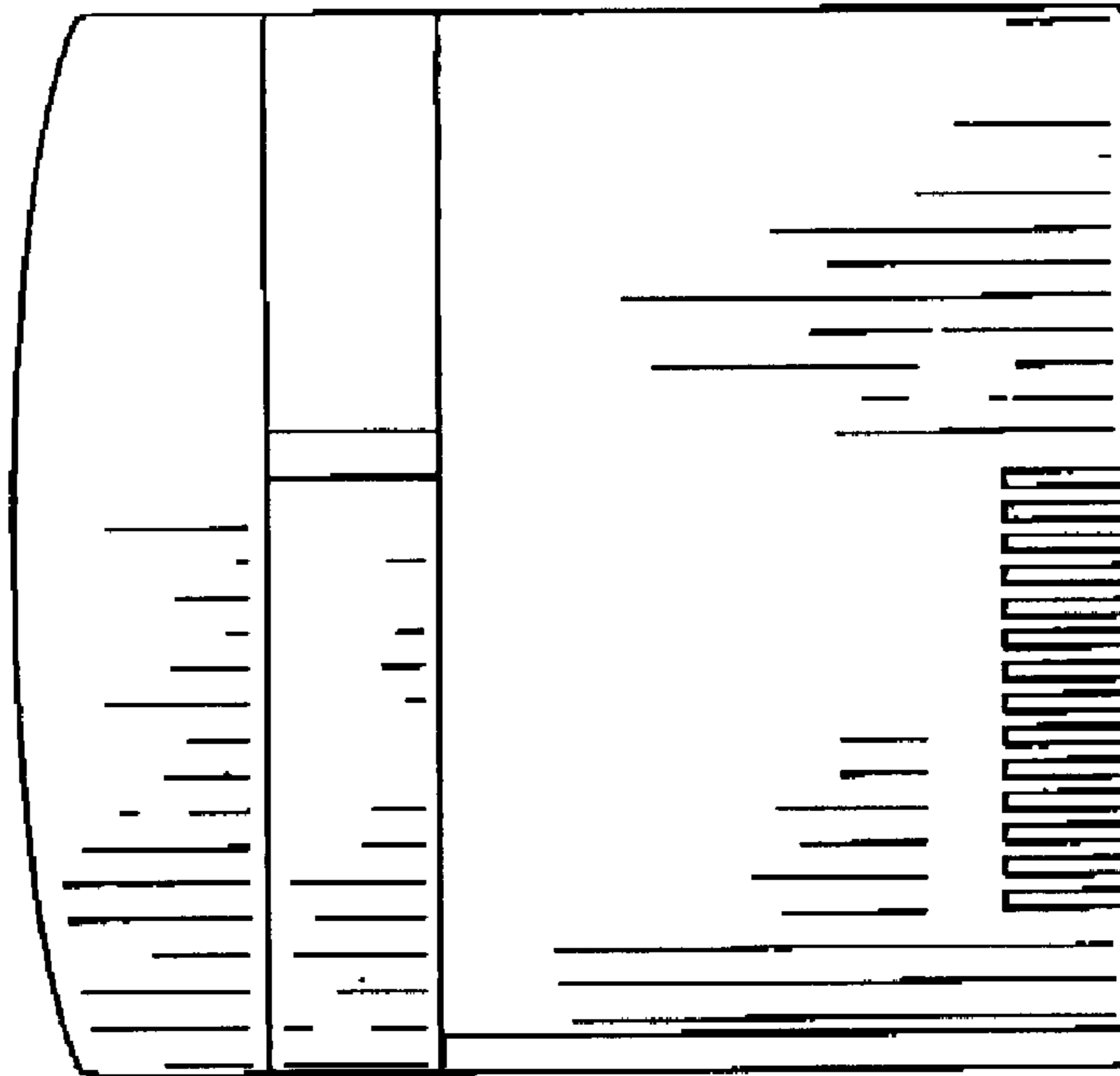

FIG. 5

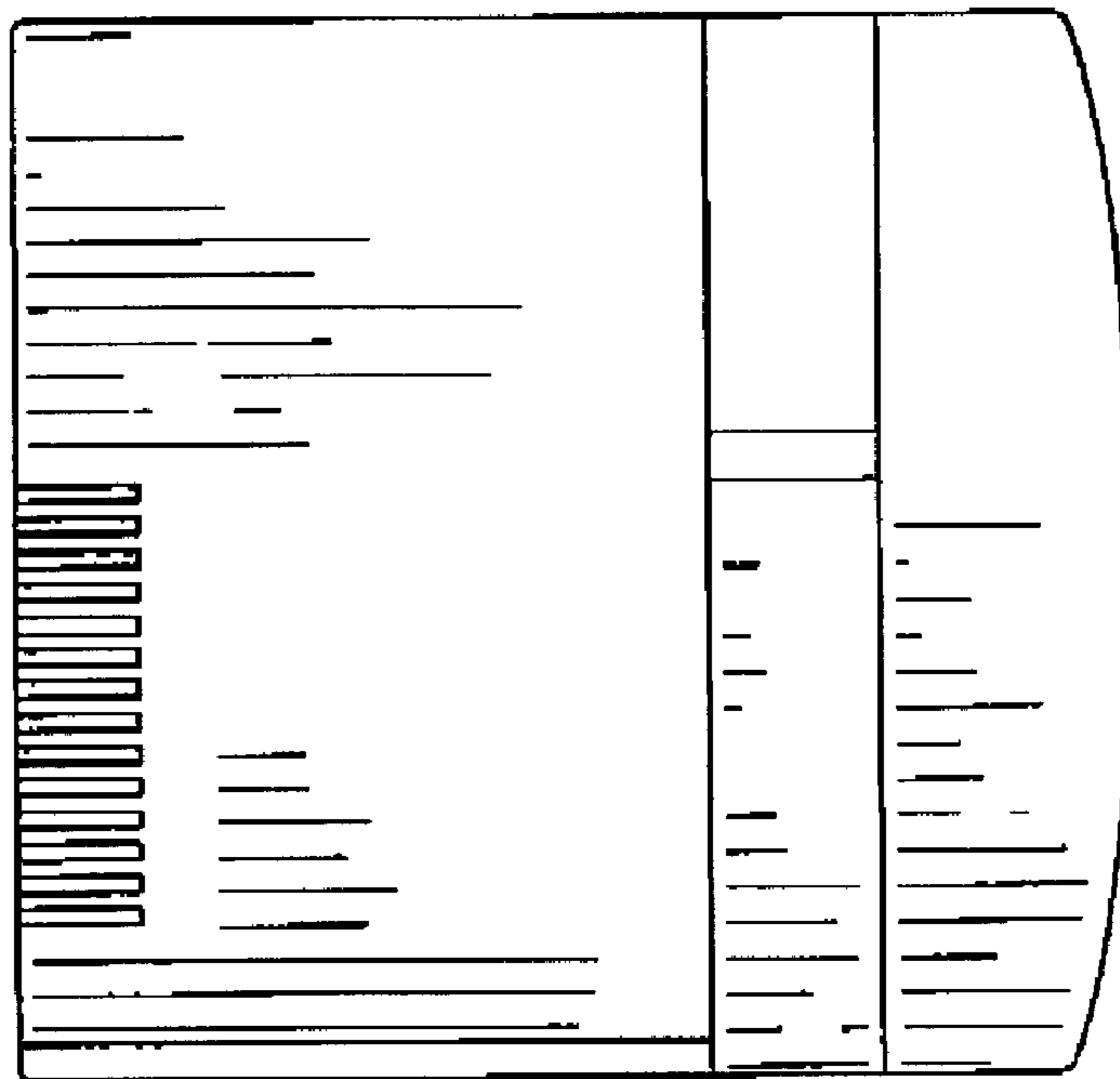

FIG. 6

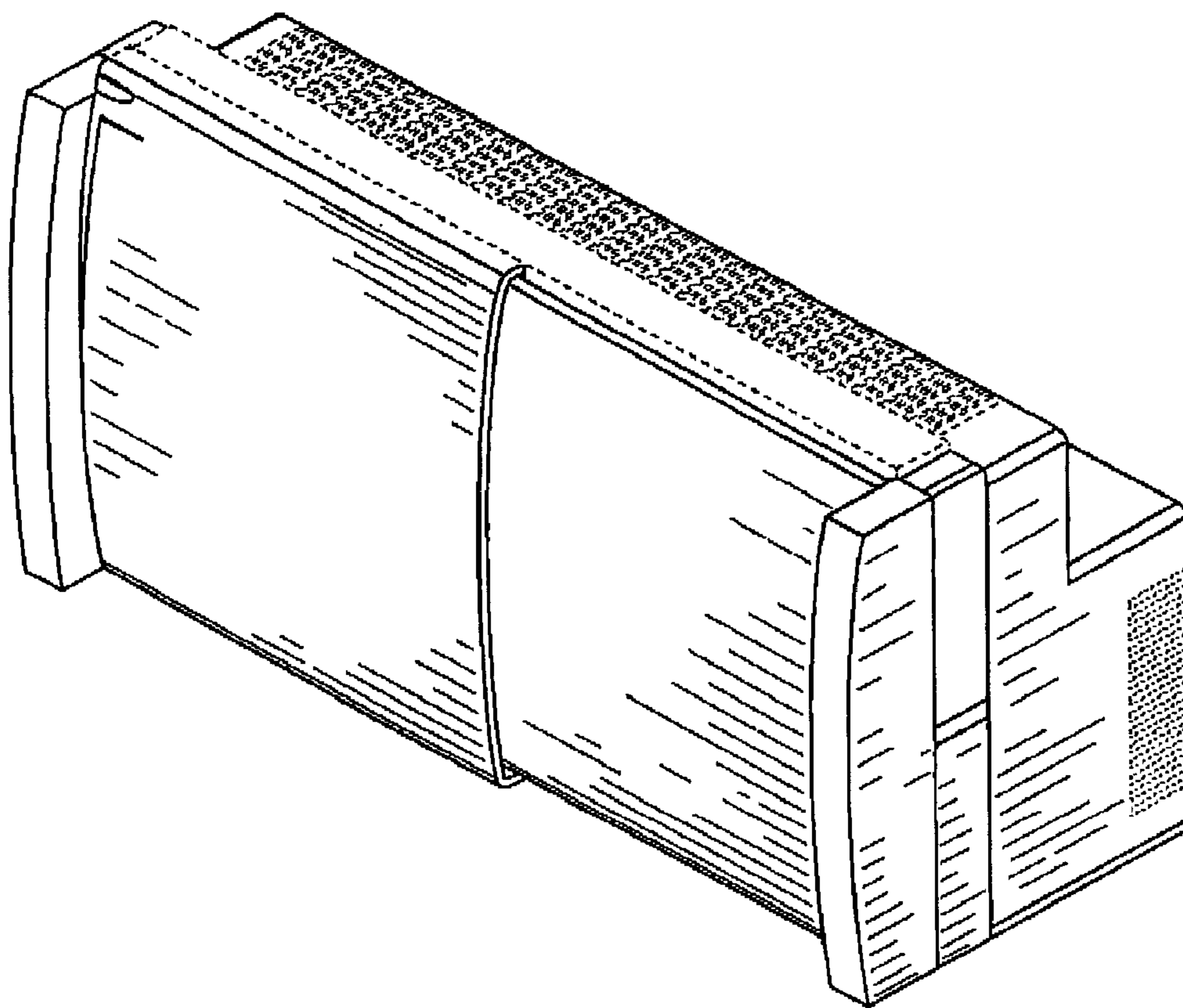

FIG. 7



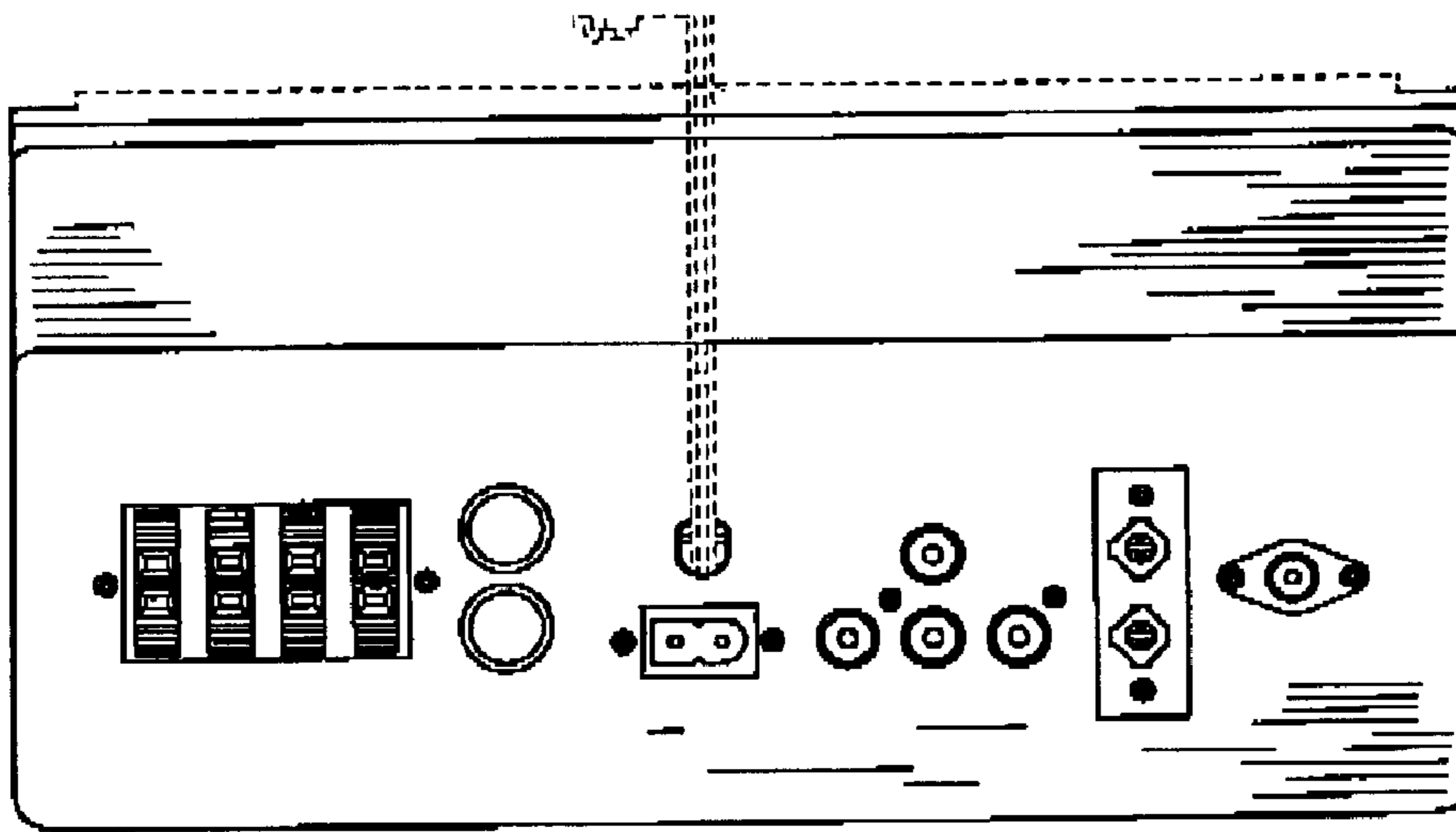

FIG. 8

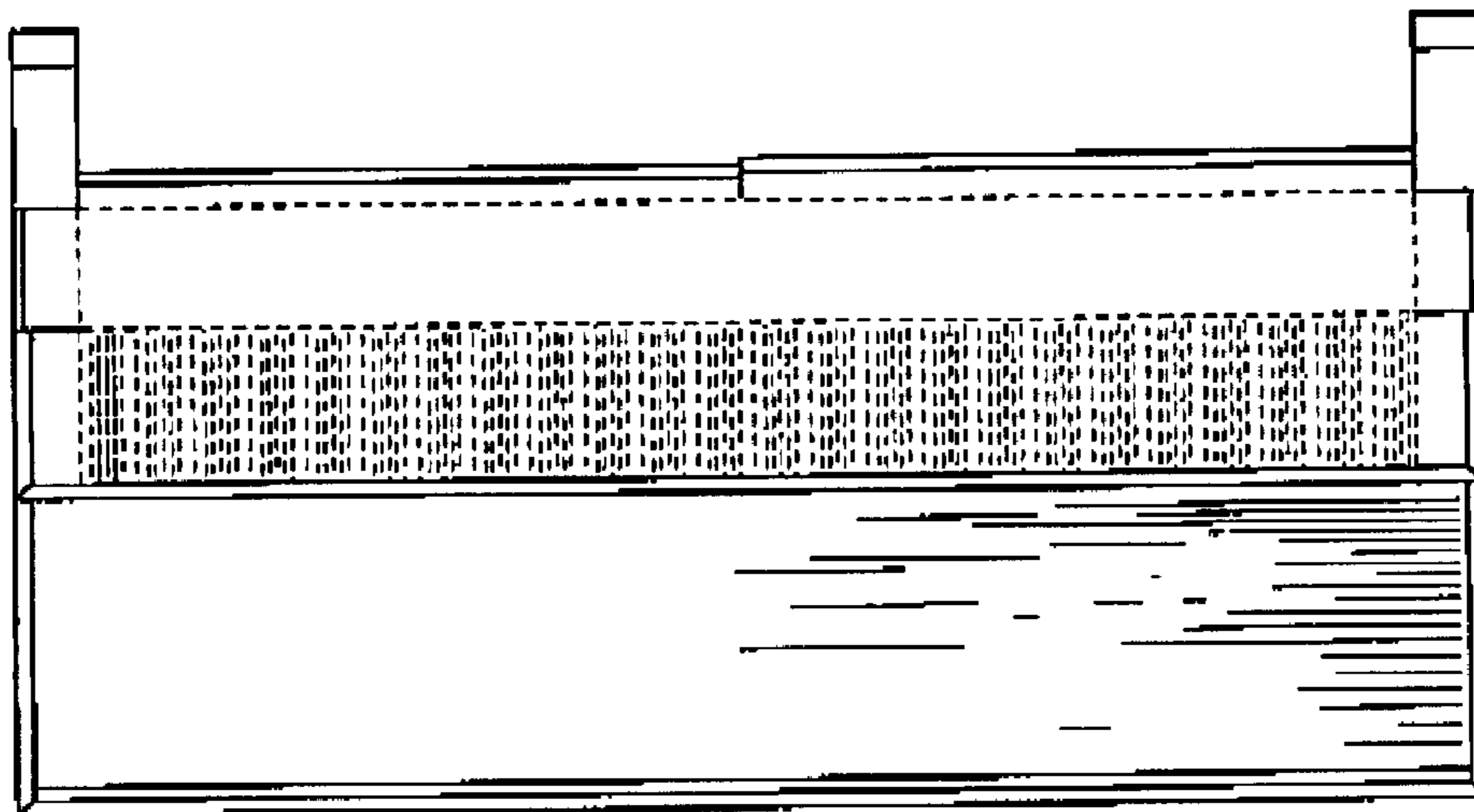

FIG. 9

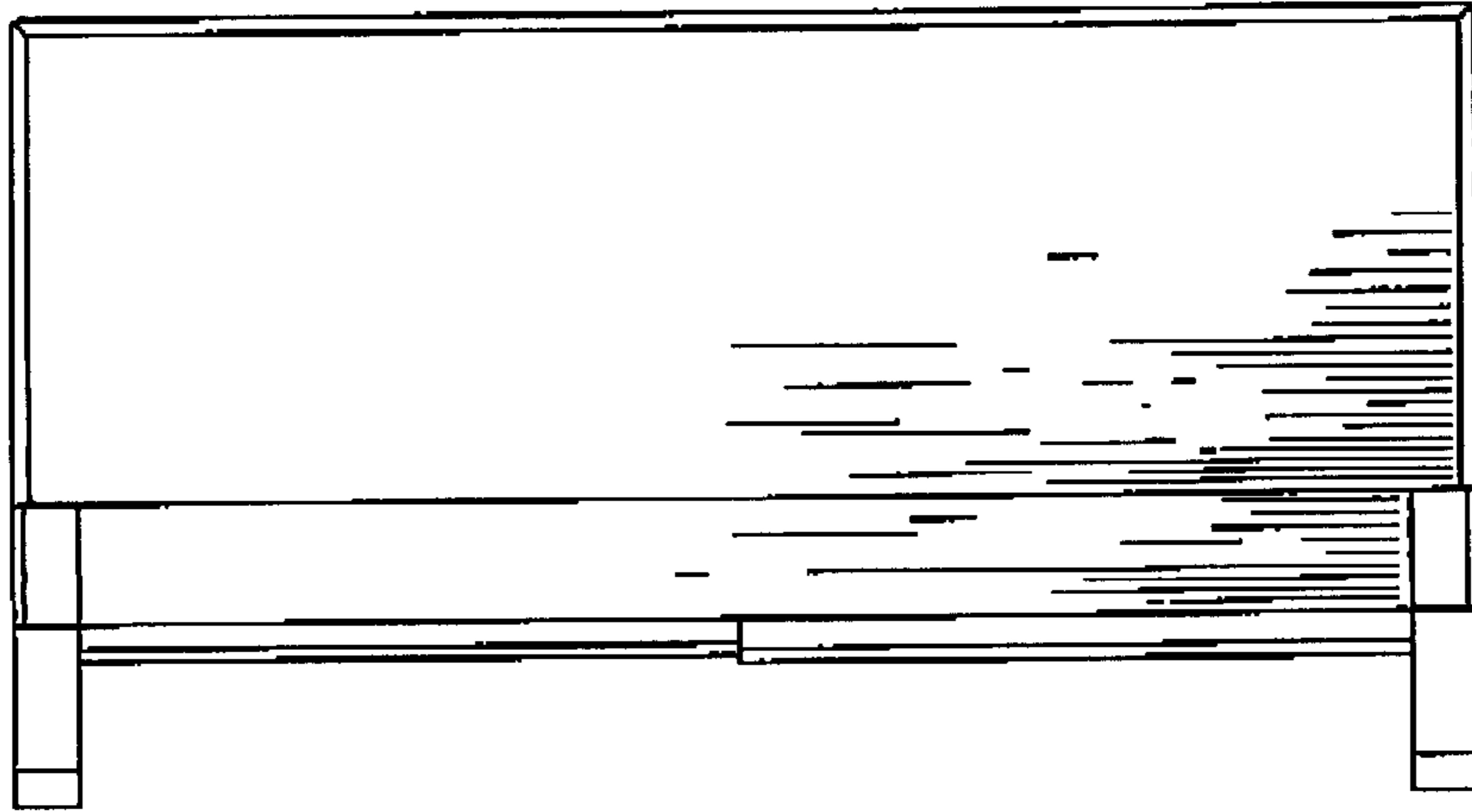

FIG. 10

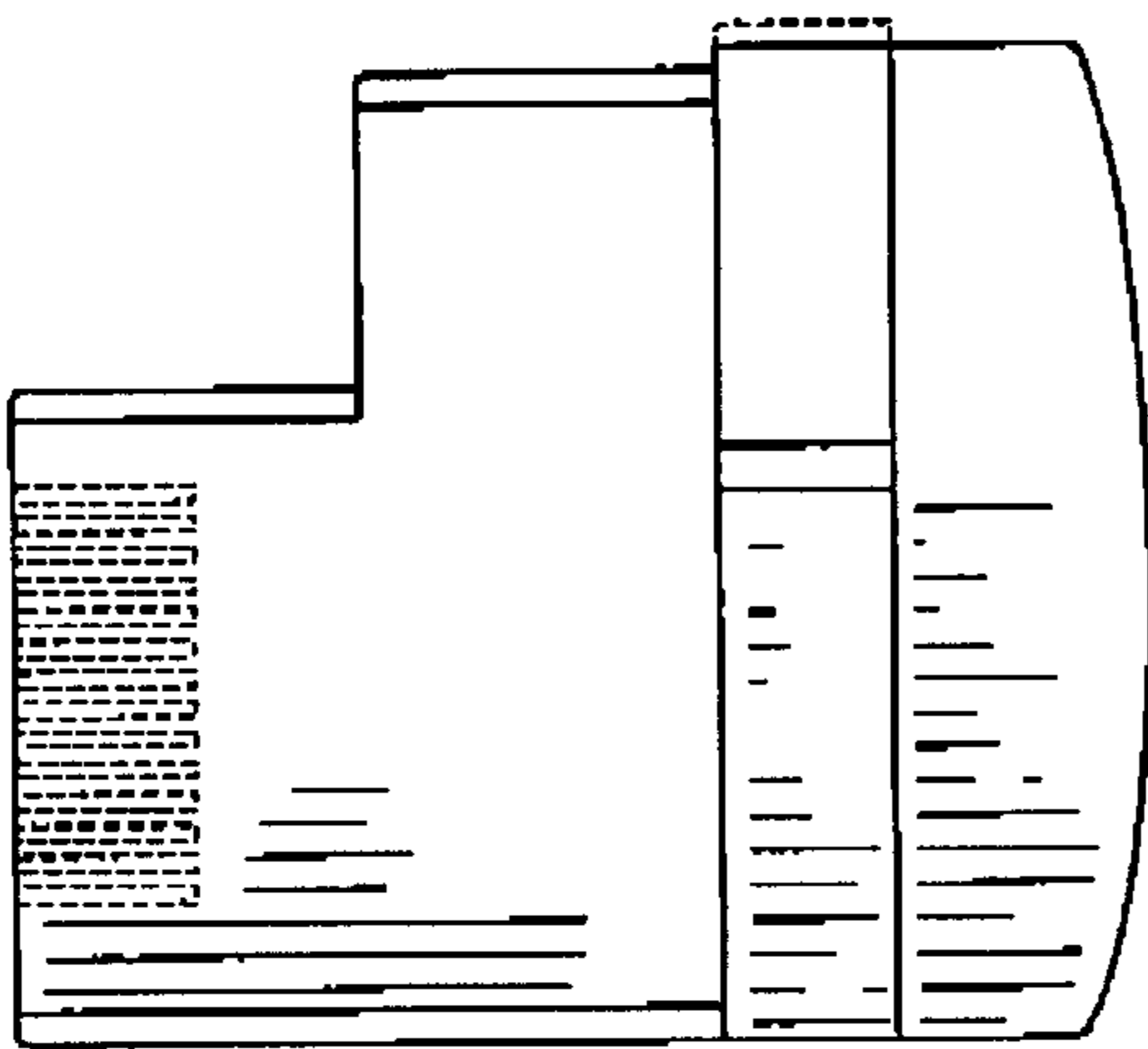

FIG. 11

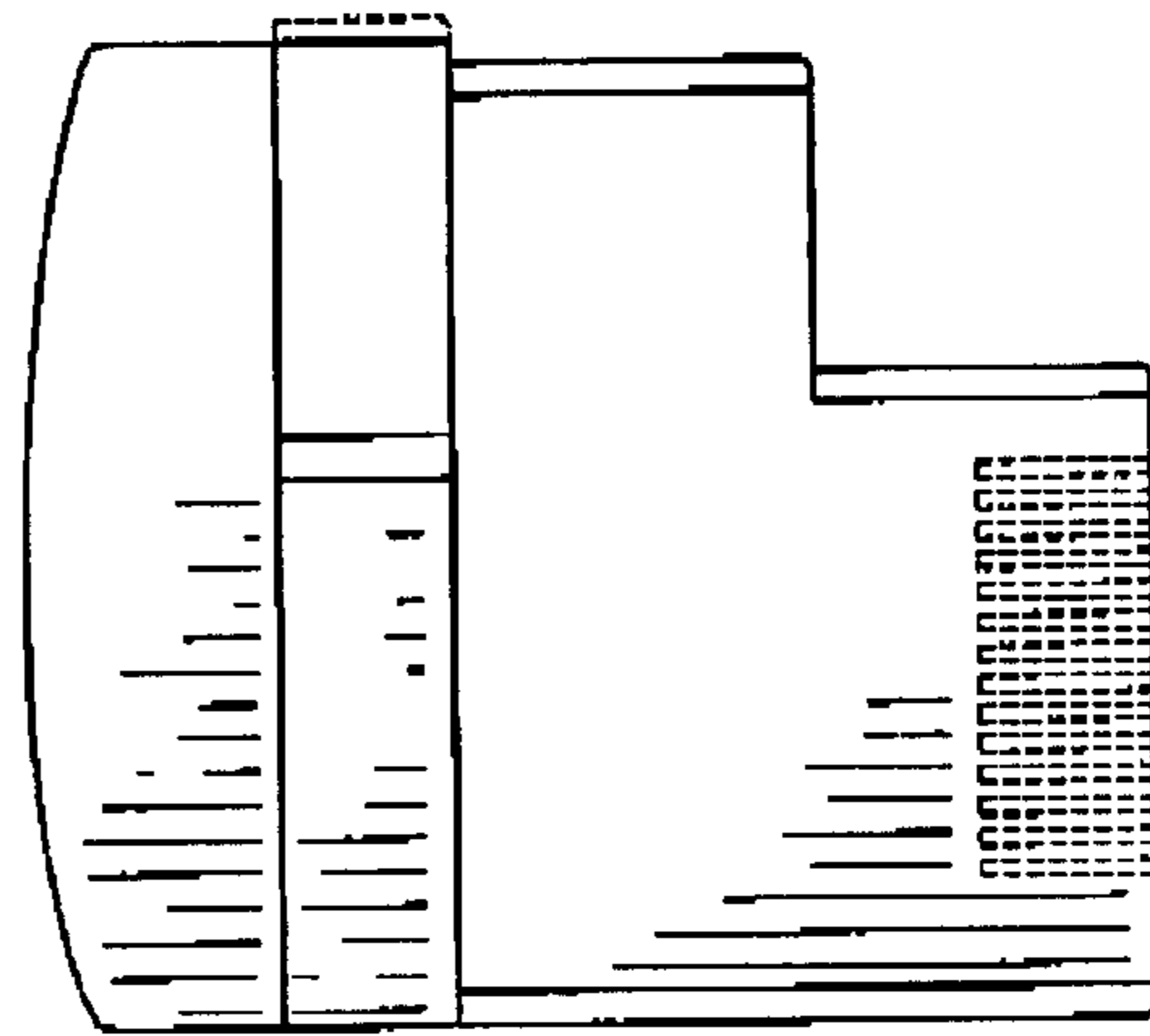

FIG. 12