



US00D529419S

(12) **United States Design Patent**  
**Richards et al.**

(10) **Patent No.:** **US D529,419 S**

(45) **Date of Patent:** **\*\* Oct. 3, 2006**

(54) **AUTOMOBILE UPPER GRILLE**

(75) Inventors: **Bradley Alan Richards**, Ann Arbor, MI (US); **Doyle Letson**, Novi, MI (US)

(73) Assignee: **Ford Global Technologies, LLC**, Dearborn, MI (US)

(\*\*) Term: **14 Years**

(21) Appl. No.: **29/246,128**

(22) Filed: **Feb. 23, 2006**

**Related U.S. Application Data**

(63) Continuation of application No. 29/229,552, filed on May 9, 2005, now abandoned.

(51) **LOC (8) Cl.** ..... **12-16**

(52) **U.S. Cl.** ..... **D12/163**

(58) **Field of Classification Search** ..... D12/163, D12/171, 90-92, 216, 169, 196; 180/68.1, 180/68.6; 296/193.11; 293/102, 113, 115  
See application file for complete search history.

(56) **References Cited**

**U.S. PATENT DOCUMENTS**

D287,711 S	*	1/1987	Stevens	.....	D12/163
D289,750 S	*	5/1987	Oki	.....	D12/163
D411,210 S	*	6/1999	Goebert et al.	.....	D12/163
D483,705 S	*	12/2003	Satou	.....	D12/163
D496,889 S	*	10/2004	Elwell et al.	.....	D12/163

**OTHER PUBLICATIONS**

TheCarConnection.com, Spy Shots: '04 Ford Fusion, Ford moves the sport-ute one size smaller. [http://www.thecarconnection.com/Enthusiasts/Spy Shots/Spy Shots 04 Ford Fusion, S178, A4609.html](http://www.thecarconnection.com/Enthusiasts/Spy%20Shots/Spy%20Shots%2004%20Ford%20Fusion,%20S178,%20A4609.html), Feb. 4, 2003.

TheCarConnection.com, Preview: 2006 Ford Futura, Ford's 427 concept morphs into Taurus replacement. <http://www.thecarconnection.com/index.asp?article=5944>, Apr. 21, 2003.

Car and Driver, The Information Dirt Road: . . . and Ford Counters With Yet Another Sketch!, p. 26, Jul. 2003.

Automotive News, *Ford Future to be built in Mexico*, p. 27, Oct. 13, 2003.

The San Diego Union-Tribune, *Automotive News: Variety at Ford, GM's Lutz Factor, Chrysler's Trucks*, Nov. 1, 2003.

Automotive News, *Ford, Collins & Aikman faces risks with Futura*, (6065) p. 22, Nov. 1, 2003.

Automotive News, *Foiled again: Ford fouls up 'Futura'*, p. 1, Apr. 5, 2004.

Automobile, *50 Sneak Peeks: Ford C-D sedan*, p. 60, May 2004.

[http://www.autointell.com/nao\\_companies/general\\_motors/concepts-2001/terra-cross-01.htm](http://www.autointell.com/nao_companies/general_motors/concepts-2001/terra-cross-01.htm), General Motors: Concepts 2001, Terra Cross: GMC Take SUV to Next Level of Sophistication.

\* cited by examiner

Primary Examiner—Melody N. Brown

(74) Attorney, Agent, or Firm—Brooks Kushman P.C.; Damian Porcari

(57) **CLAIM**

The ornamental design for an automobile upper grille, as shown and described.

**DESCRIPTION**

FIG. 1 is a perspective view of the automobile upper grille thereof;

FIG. 2 is a front view thereof;

FIG. 3 is a top plan view thereof; and

FIG. 4 is a right side elevational view, the left side elevational view being a mirror image thereof.

FIG. 5 is a perspective view of a second embodiment of the present invention;

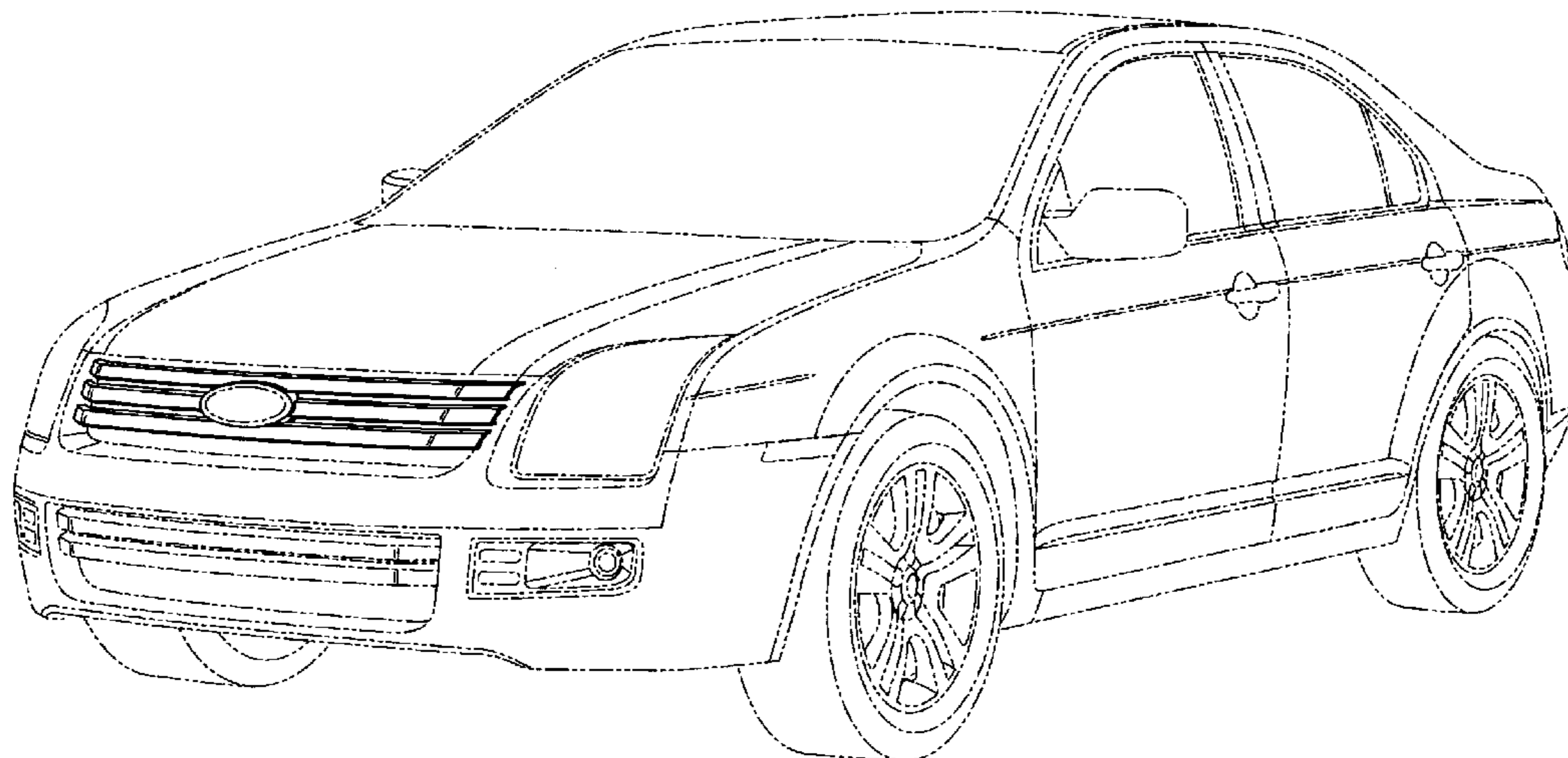
FIG. 6 is a front view of the second embodiment shown in FIG. 5;

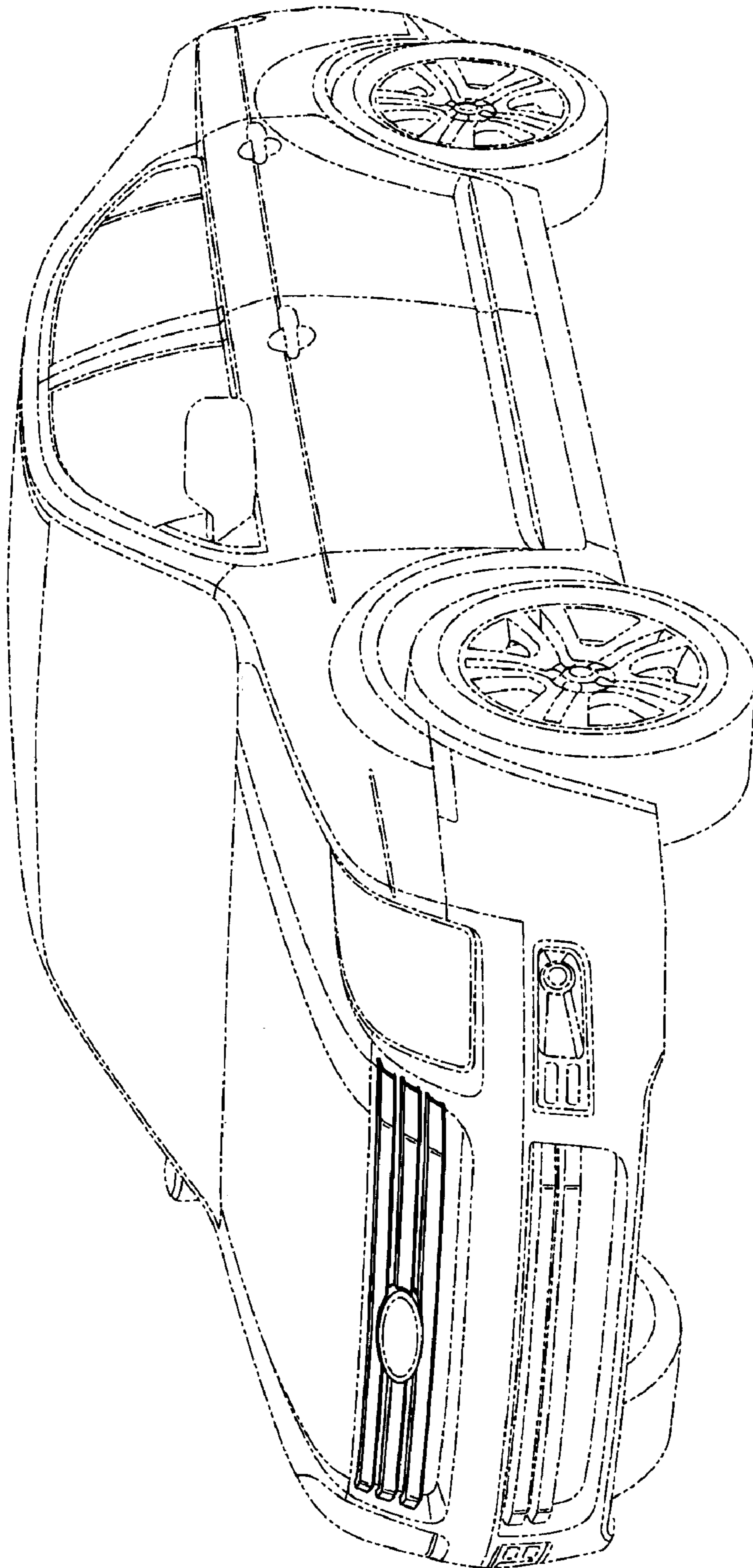
FIG. 7 is a top plan view of the second embodiment shown in FIG. 5; and,

FIG. 8 is a right side elevational view of the second embodiment shown in FIG. 5, the left side elevational view being a mirror image thereof.

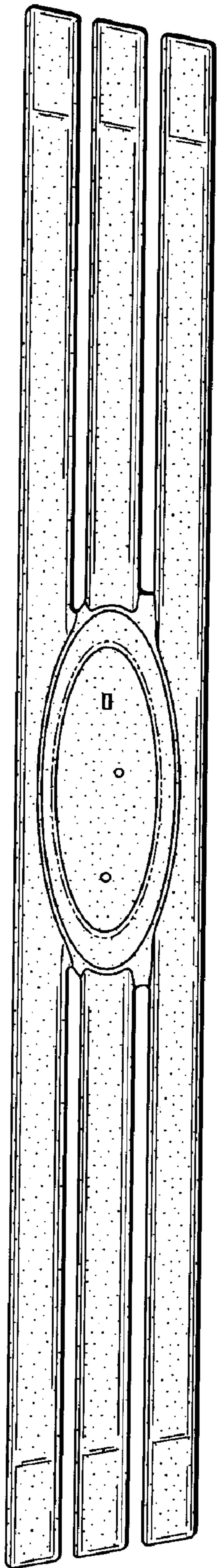
The broken lines are for illustrative purposes only and form no part of the claimed design.

**1 Claim, 4 Drawing Sheets**

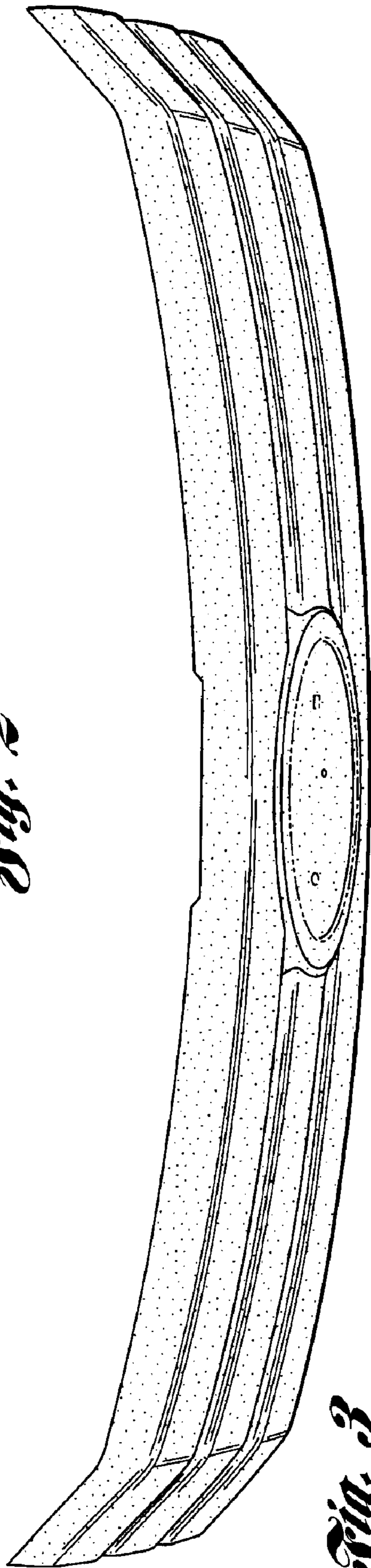




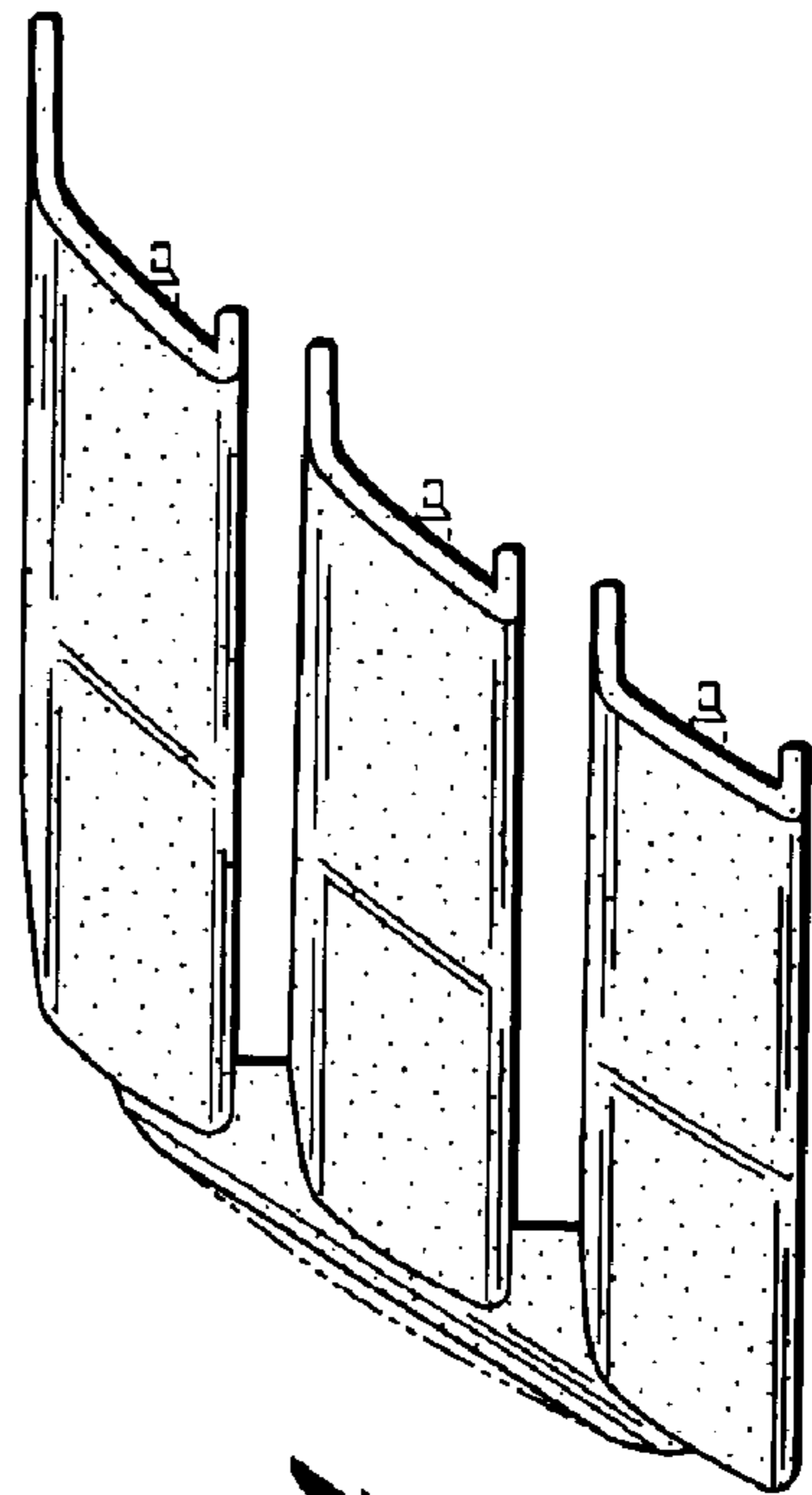
*Fig. 1*



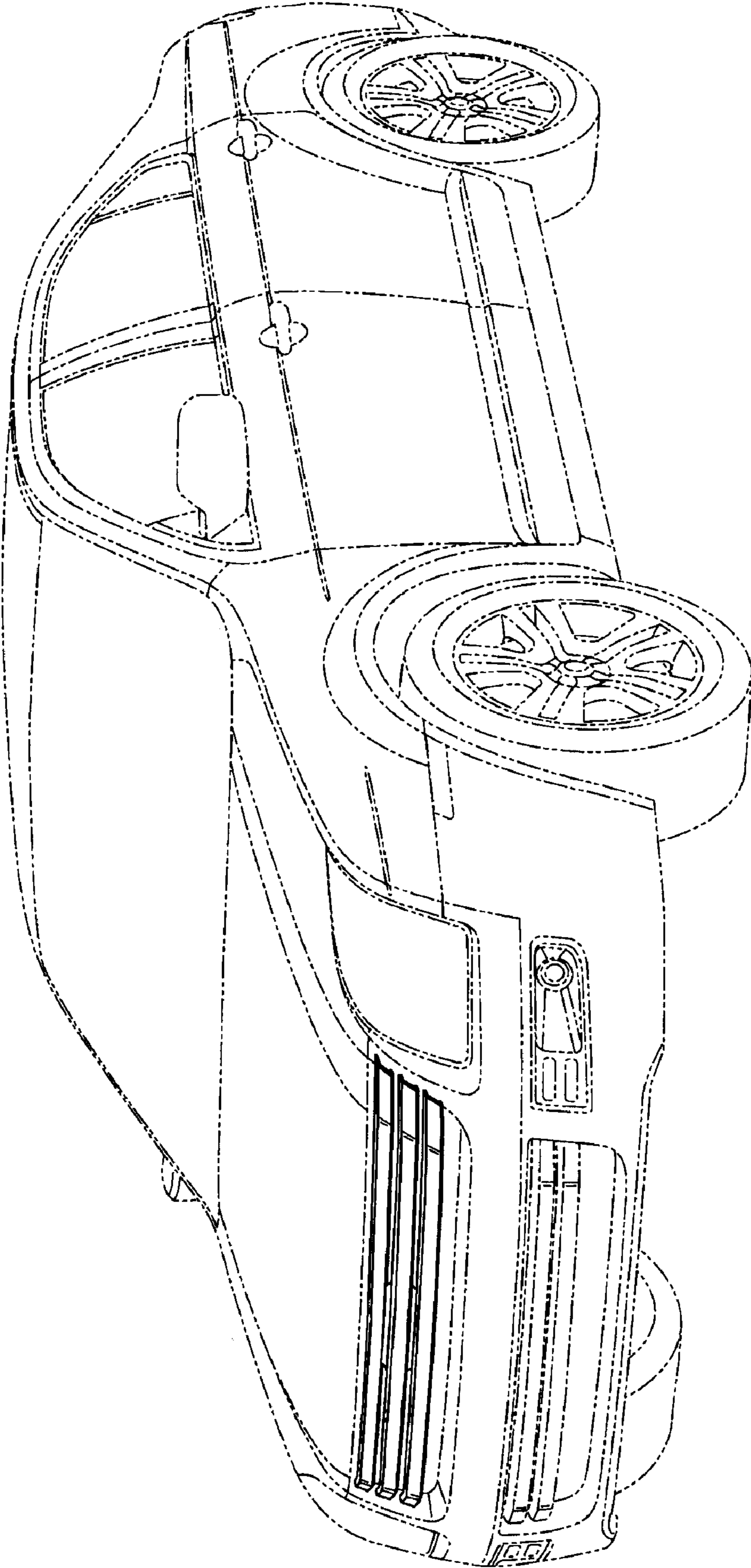
*Fig. 2*



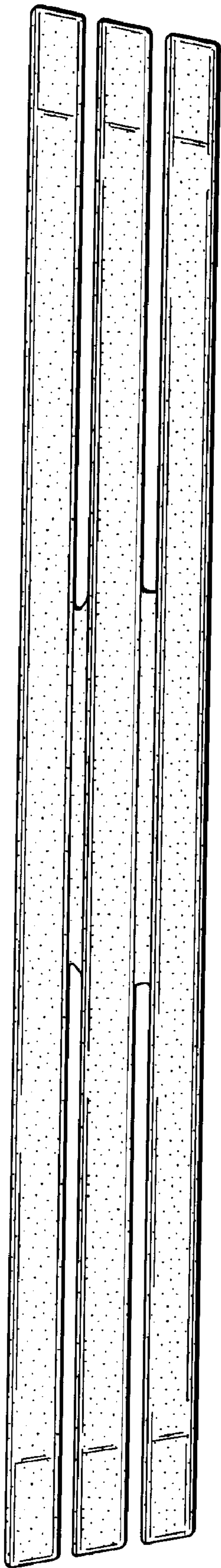
*Fig. 3*



*Fig. 4*



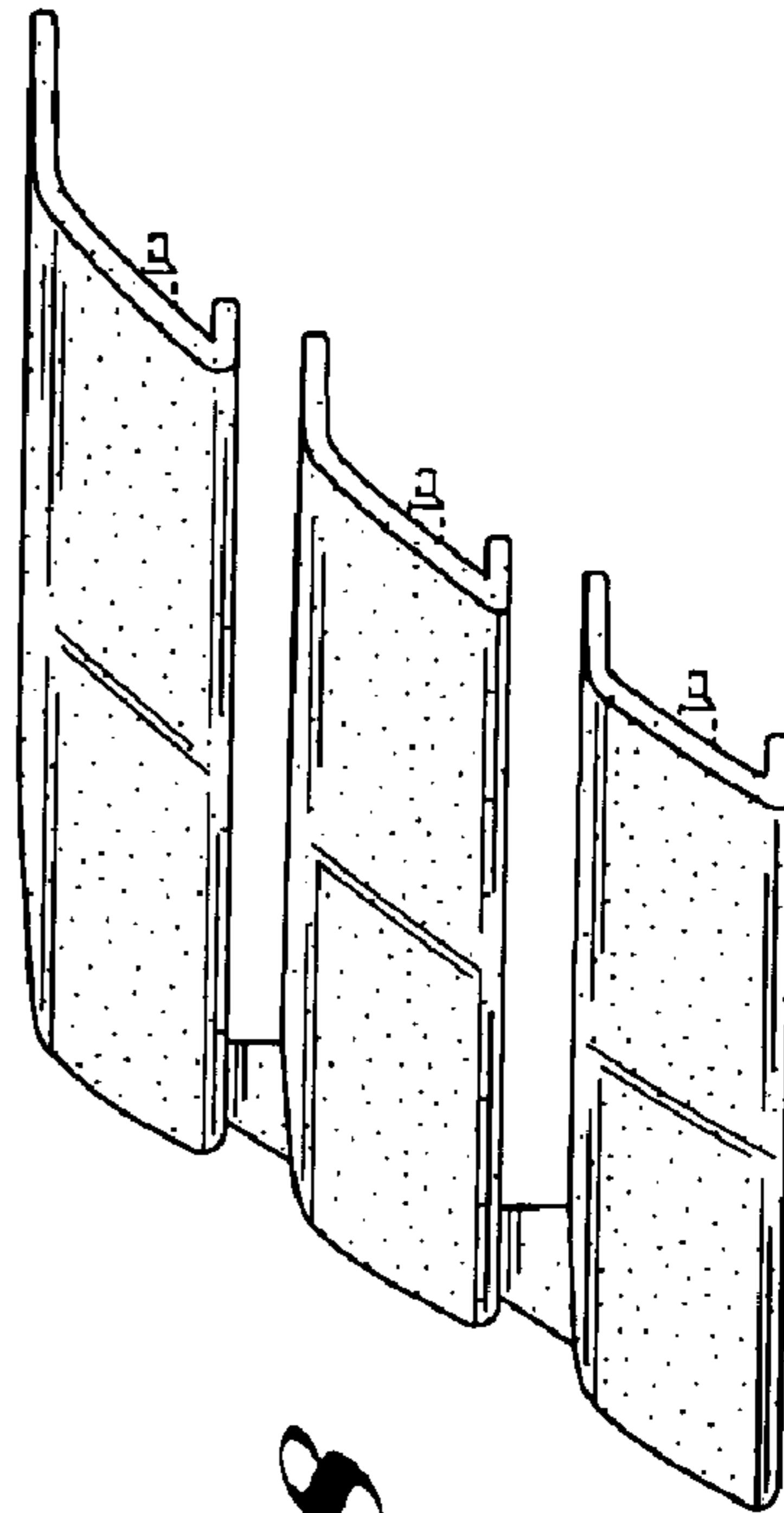
*Fig. 5*



*Fig. 6*



*Fig. 7*



*Fig. 8*