



US00D529415S

(12) **United States Design Patent**
Shimada et al.

(10) **Patent No.:** **US D529,415 S**
(45) **Date of Patent:** **** Oct. 3, 2006**

(54) **MOTOR SCOOTER**

(75) Inventors: **Haruo Shimada**, Wako (JP); **Kazuhiro Sakamoto**, Wako (JP)

(73) Assignee: **Honda Motor Co., Ltd.**, Tokyo (JP)

(**) Term: **14 Years**

(21) Appl. No.: **29/234,831**

(22) Filed: **Jul. 25, 2005**

(30) **Foreign Application Priority Data**

Jan. 31, 2005 (JP) 2005-002348

(51) **LOC (8) Cl.** **12-11**

(52) **U.S. Cl.** **D12/110**

(58) **Field of Classification Search** D12/110;
180/219, 220, 225, 229

See application file for complete search history.

(56) **References Cited**

U.S. PATENT DOCUMENTS

D286,521 S * 11/1986 Tanaka et al. D12/110

D290,824 S * 7/1987 Miura et al. D12/110

* cited by examiner

Primary Examiner—Alan P. Douglas

Assistant Examiner—Linda Brooks

(74) *Attorney, Agent, or Firm*—Sughrue Mion, PLLC

(57) **CLAIM**

The ornamental design for a motor scooter, as shown.

DESCRIPTION

FIG. 1 is a perspective view of the top, front and right side of a motor scooter showing our new design;

FIG. 2 is a perspective view of the top, front and left side thereof;

FIG. 3 is a perspective view of the top, rear and right side thereof;

FIG. 4 is a perspective view of the top, rear and left side thereof;

FIG. 5 is a right side elevational view thereof;

FIG. 6 is a left side elevational view thereof;

FIG. 7 is a top plan view thereof;

FIG. 8 is a bottom plan view thereof;

FIG. 9 is a rear elevational view thereof; and,

FIG. 10 is a front elevational view thereof.

1 Claim, 10 Drawing Sheets

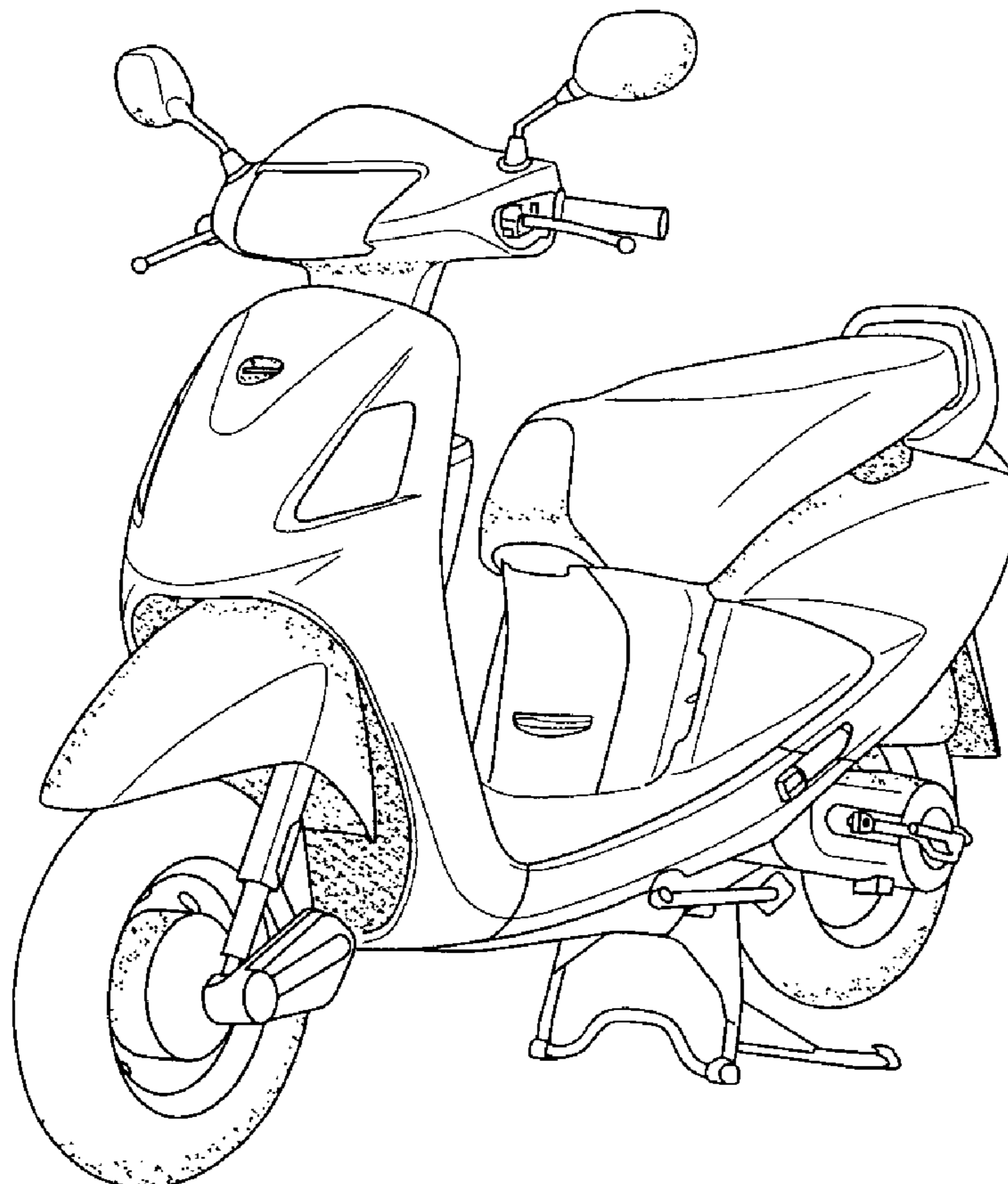

FIG. 1

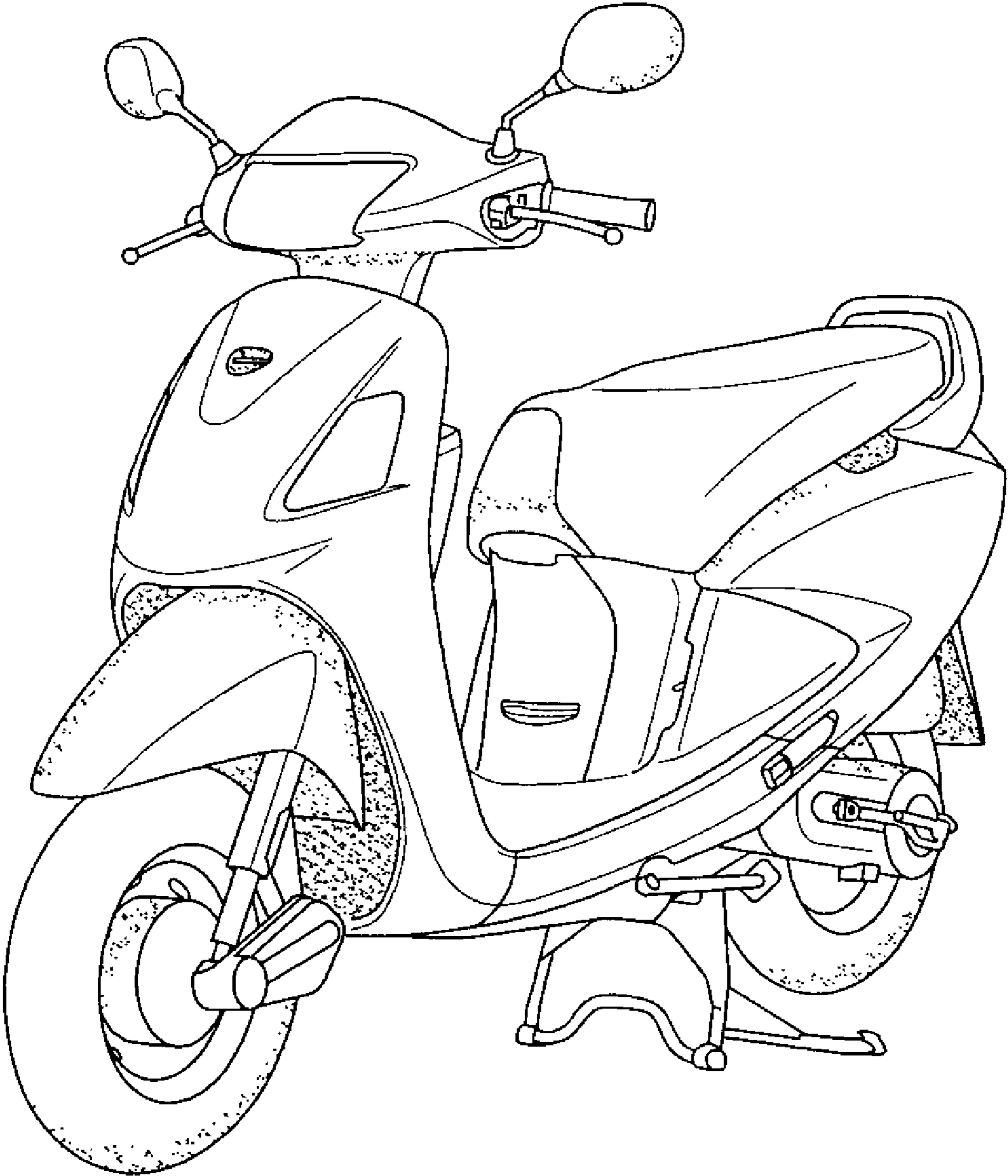

FIG. 2

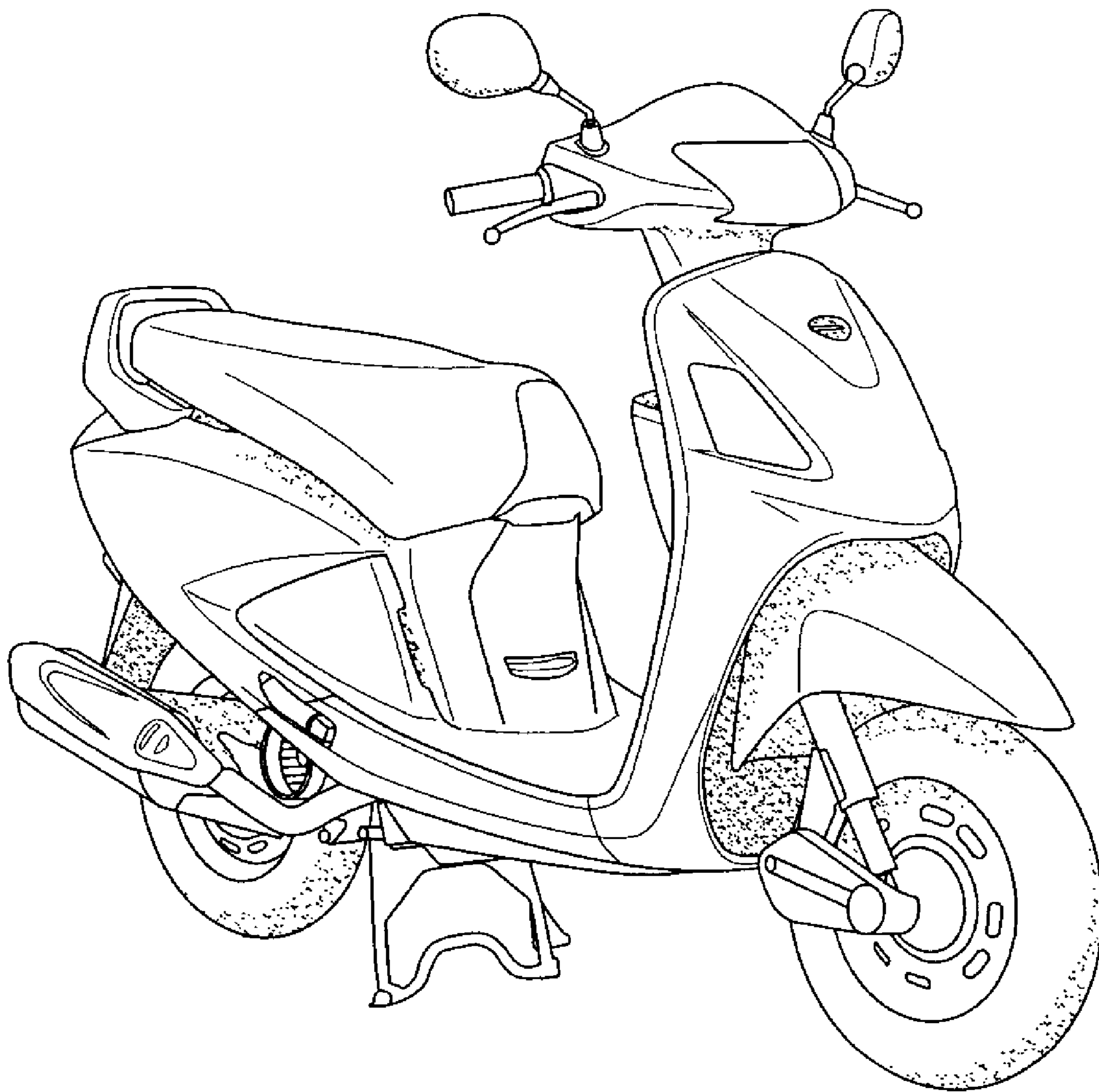

FIG. 3

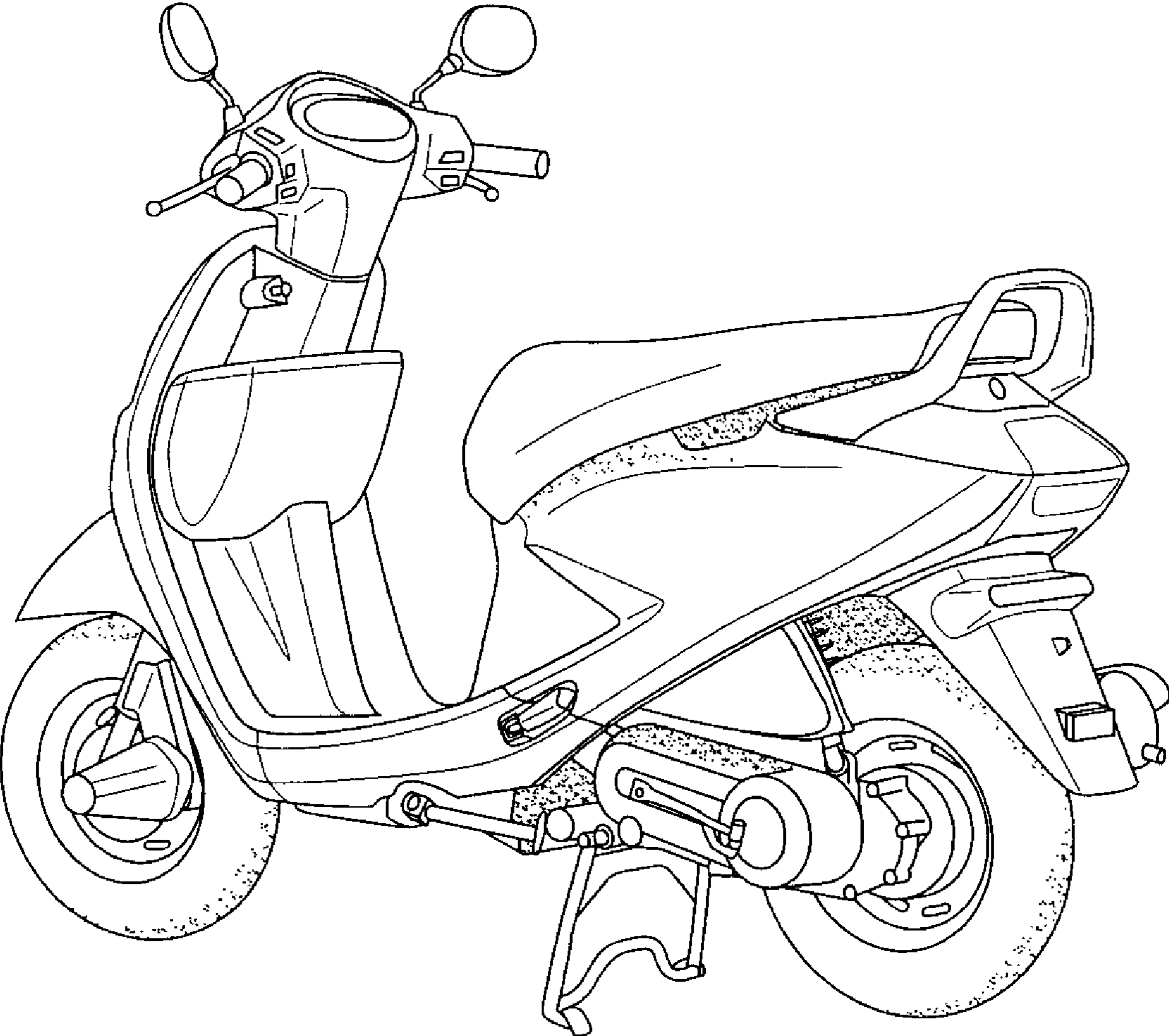

FIG. 4

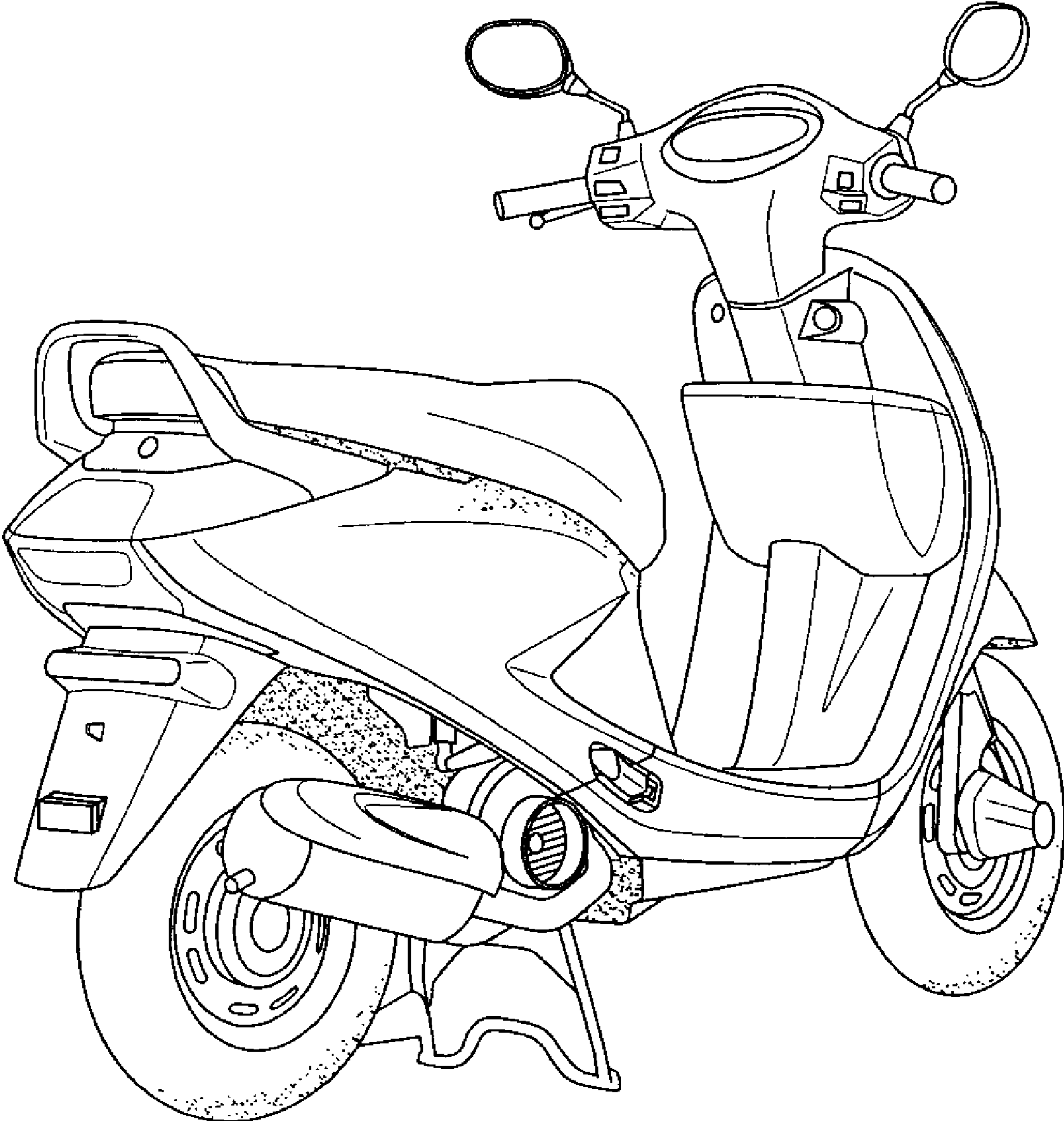

FIG. 5

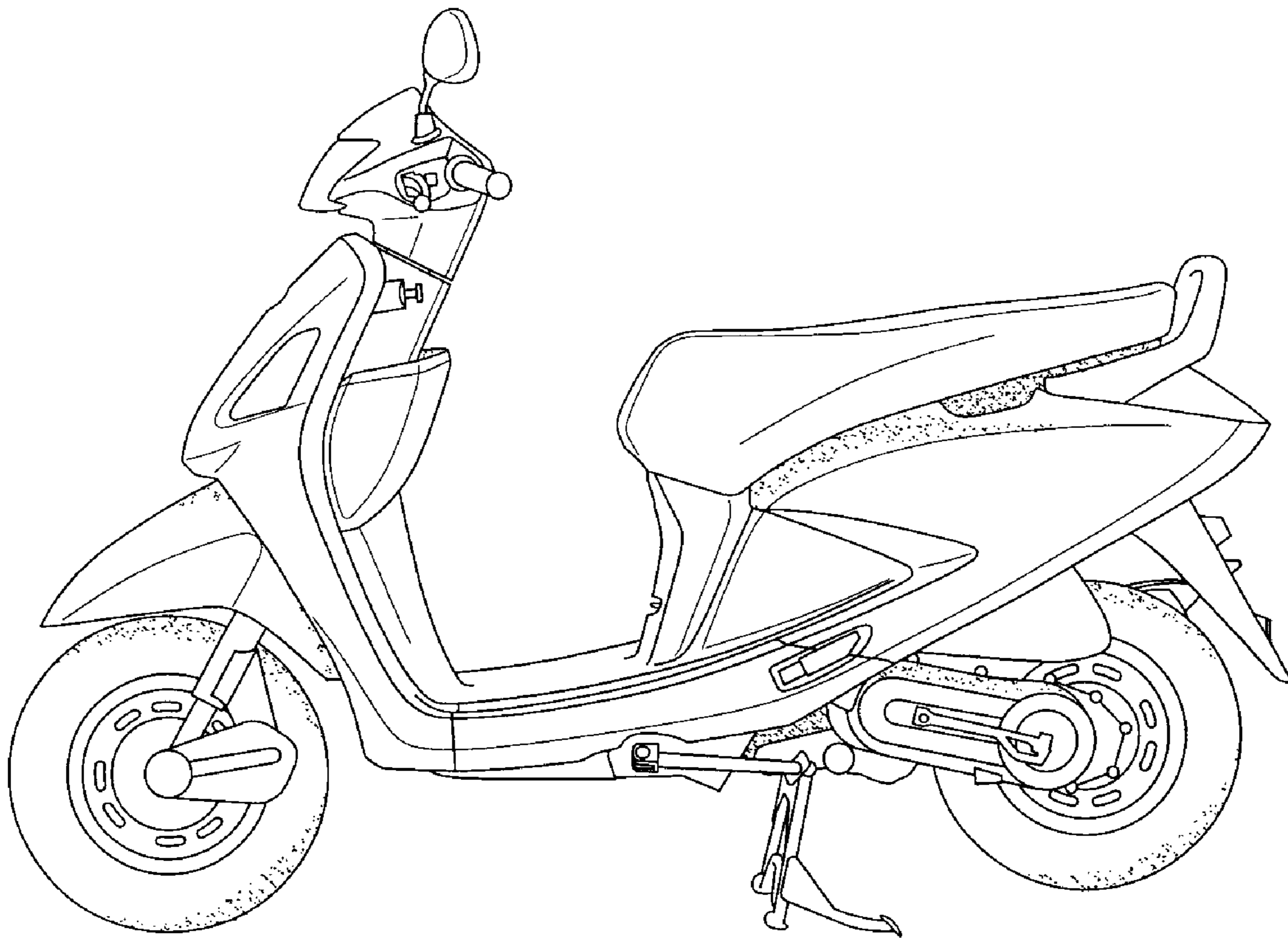

FIG. 6

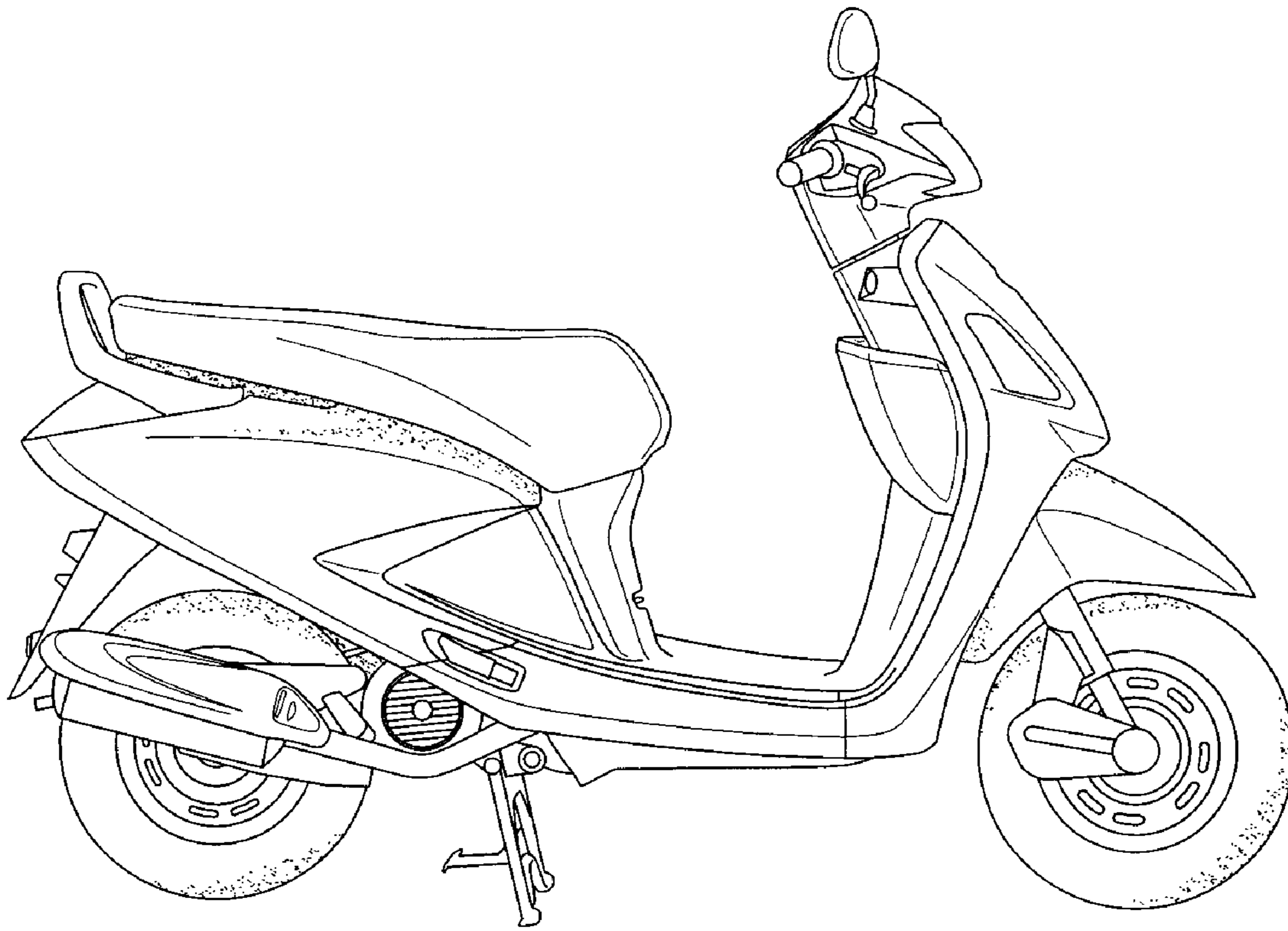

FIG. 7

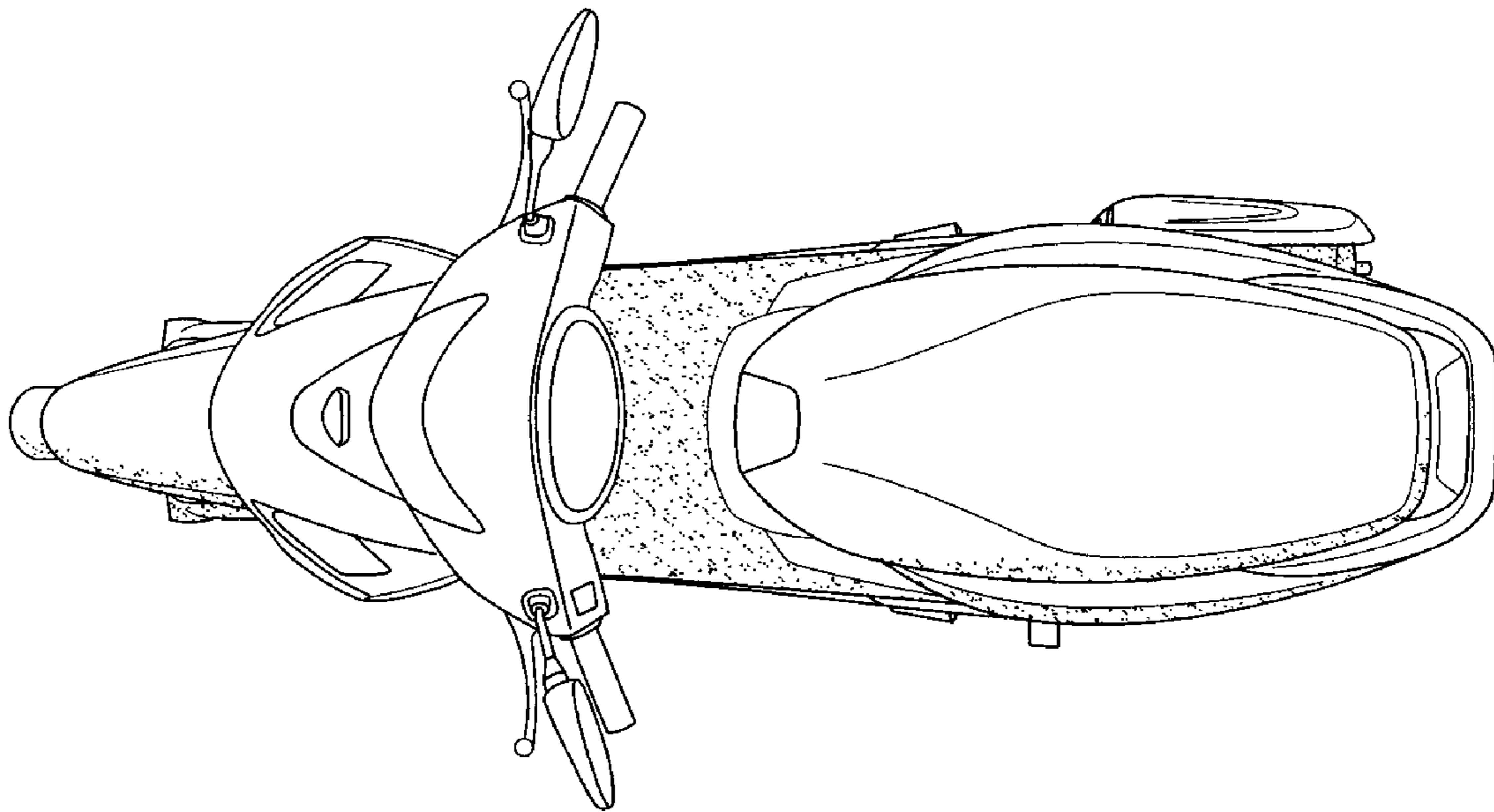

FIG. 8

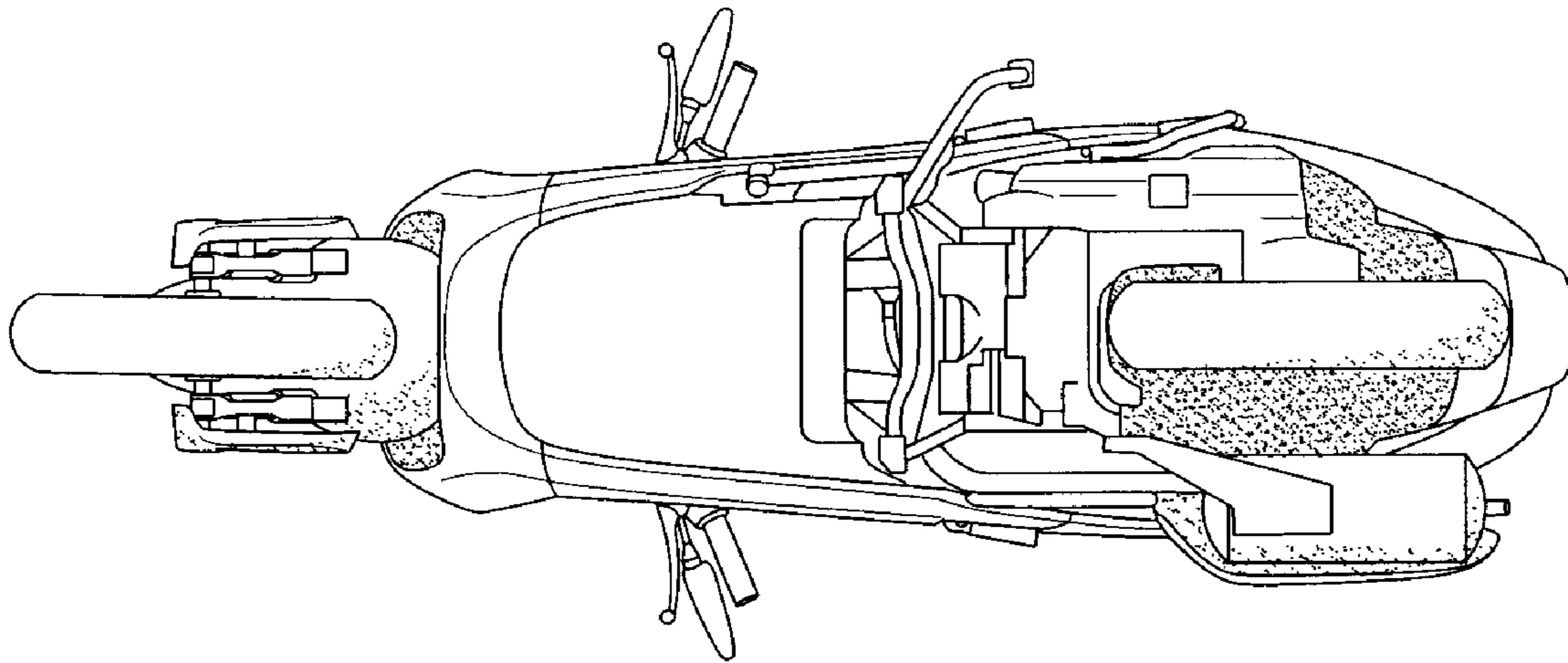

FIG. 9

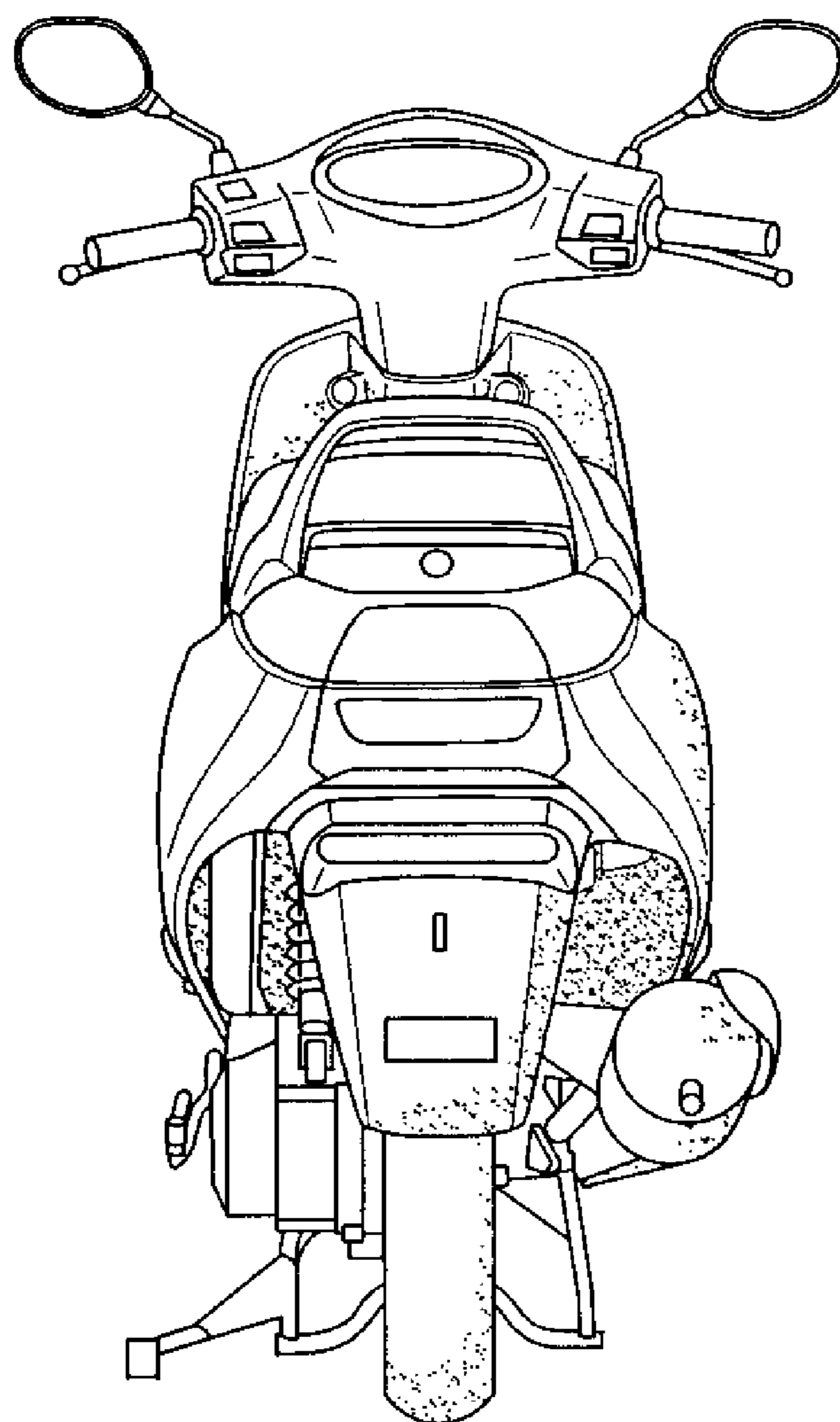

FIG. 10

