



US00D529354S

(12) **United States Design Patent**  
**Davis et al.**

(10) **Patent No.:** **US D529,354 S**

(45) **Date of Patent:** **\*\* Oct. 3, 2006**

(54) **ROTARY TOOL**

(75) Inventors: **Josh Davis**, Crystal Lake, IL (US);  
**Daniel Williams**, Chicago, IL (US)

(73) Assignee: **Credo Technology Corporation**,  
Wilmington, DE (US)

(\*\*) Term: **14 Years**

(21) Appl. No.: **29/228,843**

(22) Filed: **Apr. 30, 2005**

(51) **LOC (8) Cl.** ..... **08-05**

(52) **U.S. Cl.** ..... **D8/61**

(58) **Field of Classification Search** ..... D8/69,  
D8/68, 67, 66, 64, 61, 70; 83/698.41, 747;  
81/57.11, 474; 173/170, 217, 168, 169  
See application file for complete search history.

(56) **References Cited**

U.S. PATENT DOCUMENTS

D310,160 S	*	8/1990	Patel	.....	D8/61
5,298,821 A	*	3/1994	Michel	.....	310/47
D374,159 S	*	10/1996	Chiang	.....	D8/61
D433,905 S	*	11/2000	Cooper	.....	D8/61
D437,757 S	*	2/2001	Thomson et al.	.....	D8/61
D446,431 S	*	8/2001	Lui	.....	D8/61

D459,176 S	*	6/2002	Duennes	.....	D8/61
D473,119 S	*	4/2003	Evans	.....	D8/61
D477,202 S	*	7/2003	Duennes	.....	D8/61
D478,259 S	*	8/2003	Heun	.....	D8/61
D510,848 S	*	10/2005	Singh et al.	.....	D8/61

\* cited by examiner

*Primary Examiner*—Cathron C. Brooks

*Assistant Examiner*—Austin Murphy

(74) *Attorney, Agent, or Firm*—Victor A. Henzi

(57) **CLAIM**

The ornamental design for a rotary tool, as shown and described.

**DESCRIPTION**

FIG. 1 is a rear left perspective view of the present new design for a rotary tool;  
FIG. 2 is a left elevational view thereof;  
FIG. 3 is a right elevational view thereof;  
FIG. 4 is a top plan view thereof;  
FIG. 5 is a bottom plan view thereof;  
FIG. 6 is a front elevational view thereof; and,  
FIG. 7 is a rear elevational view thereof.

The broken lines showing various features of a rotary tool are for illustrative purposes only and form no part of the claimed design.

**1 Claim, 6 Drawing Sheets**

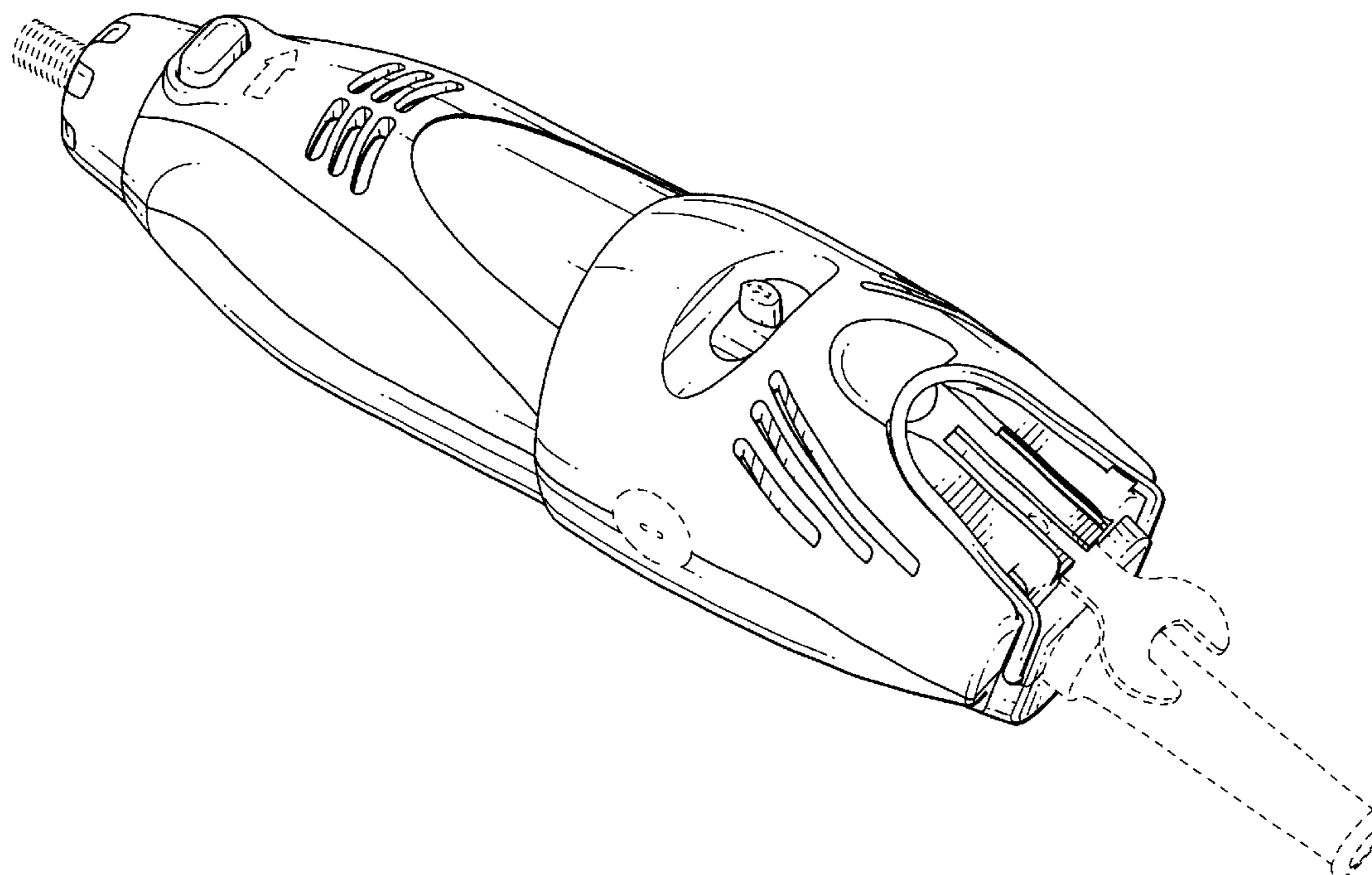

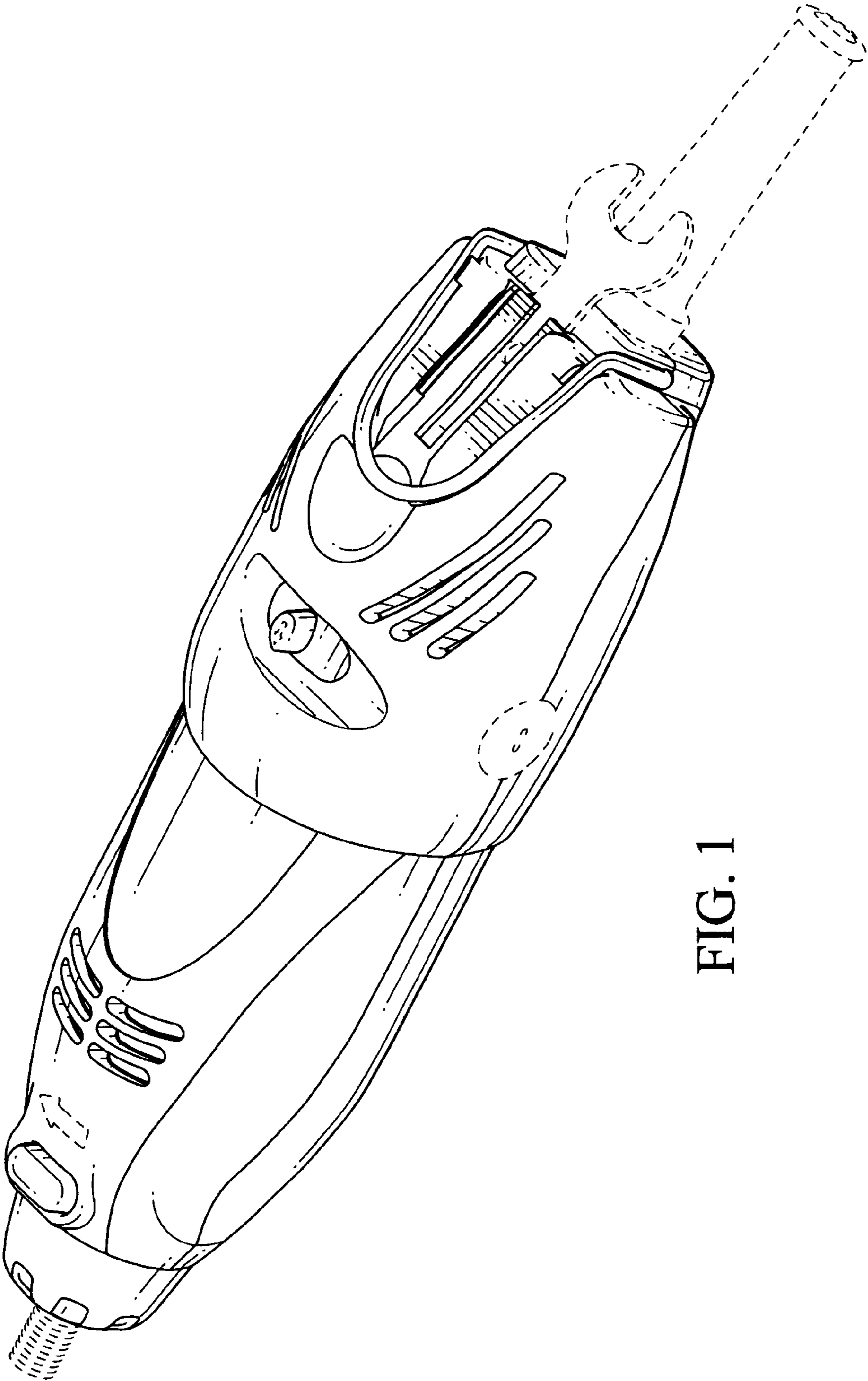

FIG. 1

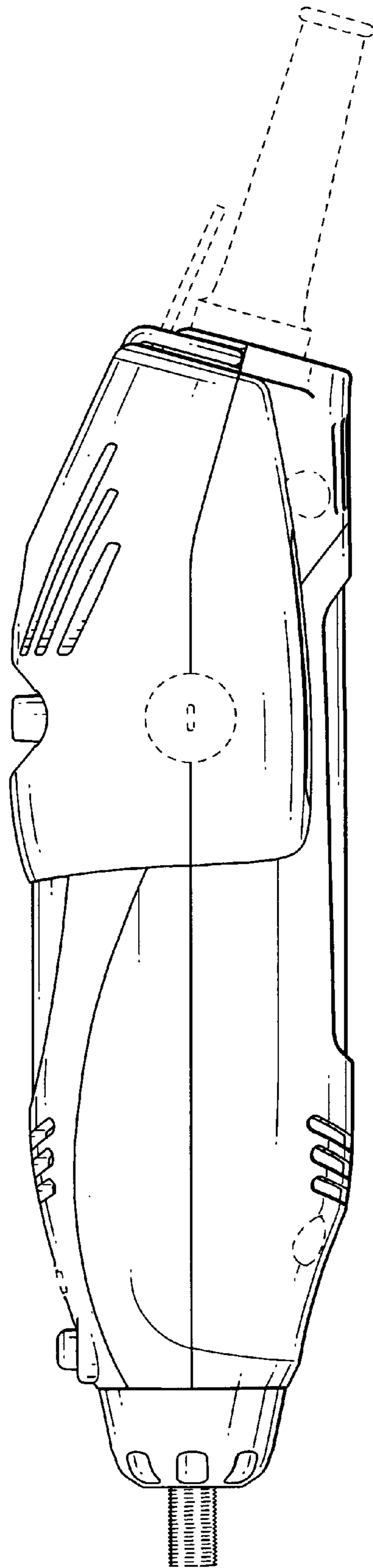

FIG. 2

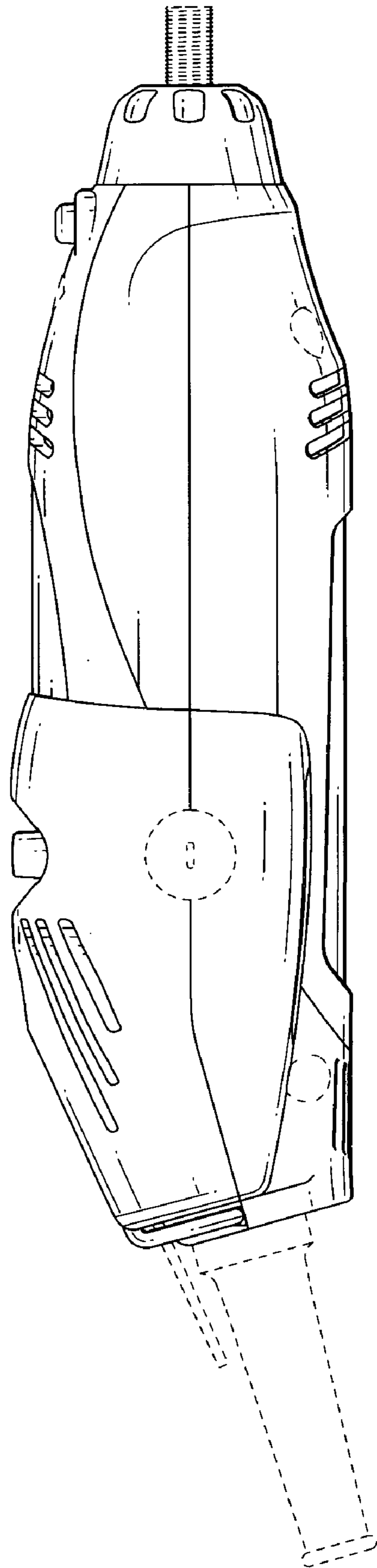

FIG. 3

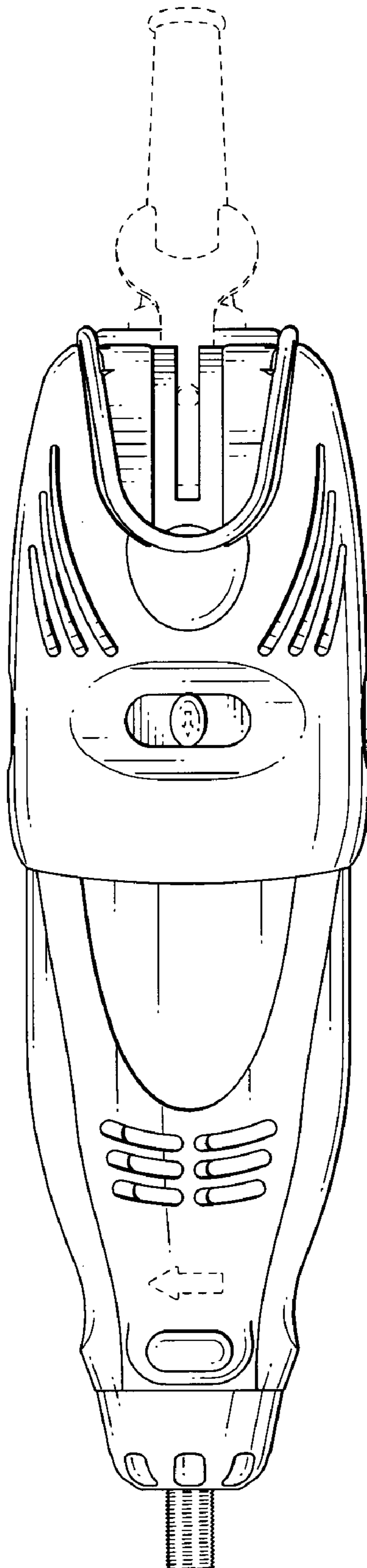

FIG. 4

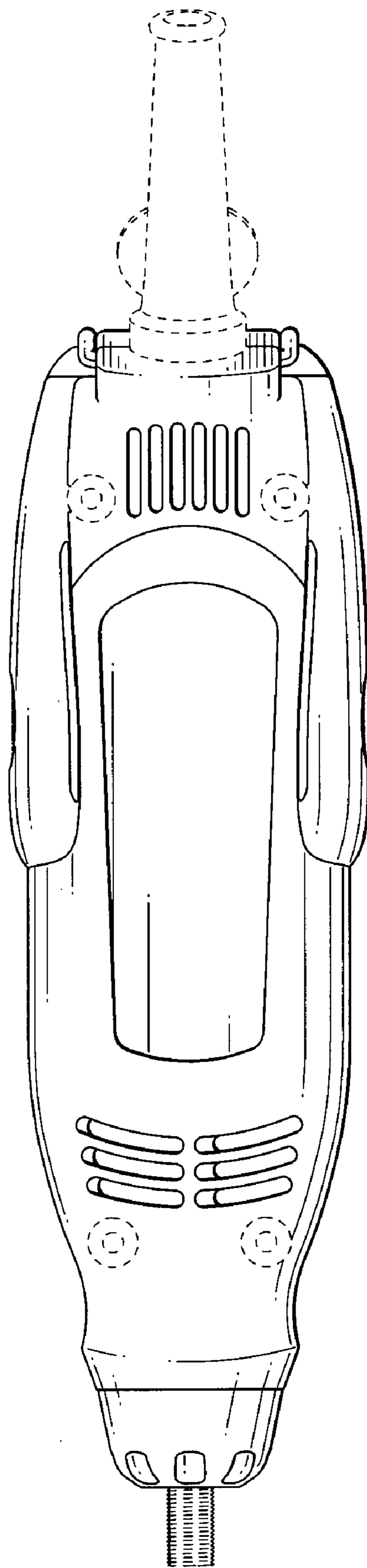

FIG. 5

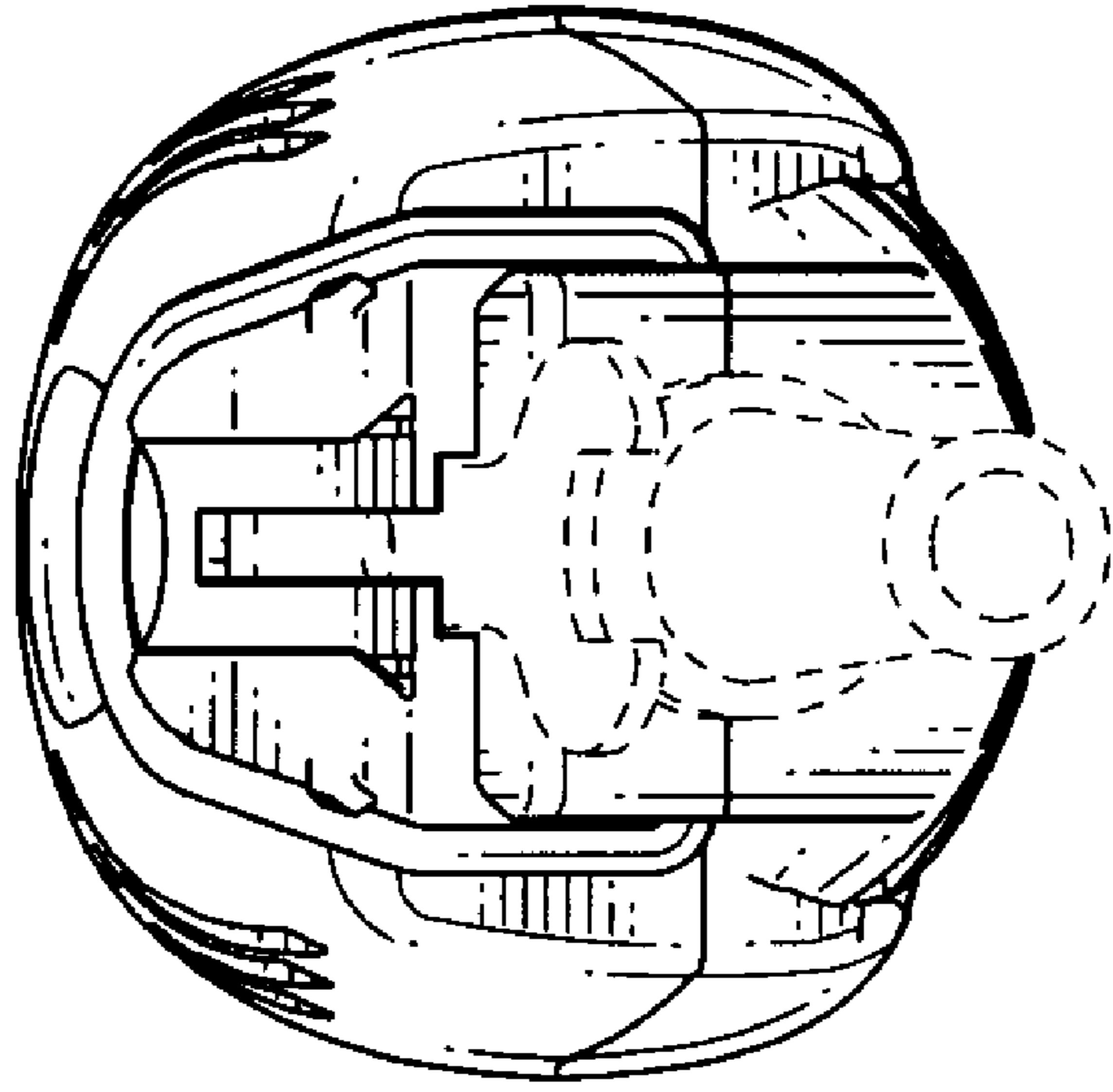

FIG. 7

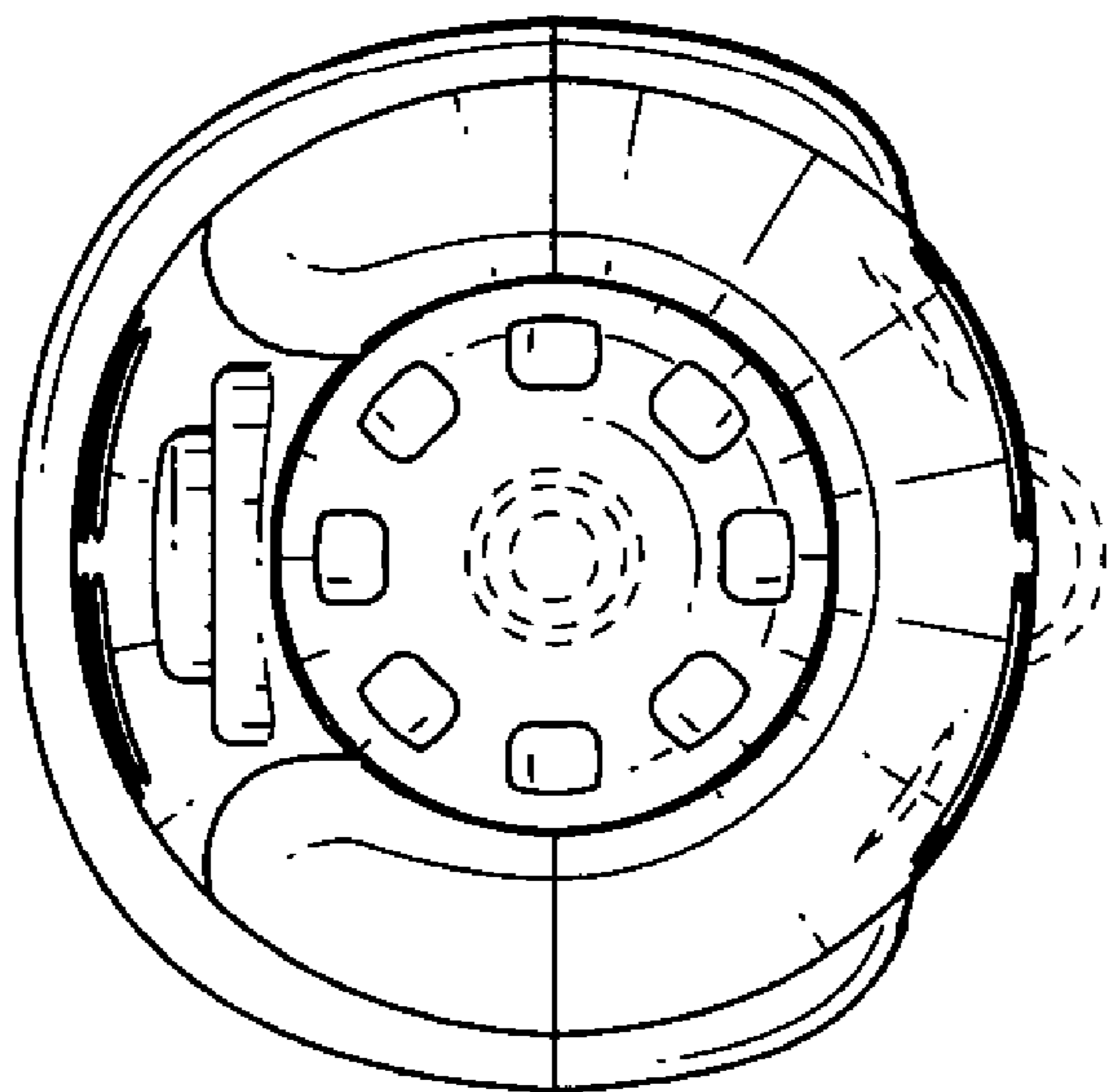

FIG. 6