

US00D529344S

(12) **United States Design Patent**  
**Maldonado**

(10) **Patent No.:** **US D529,344 S**

(45) **Date of Patent:** **\*\* Oct. 3, 2006**

(54) **SOFTSIDE COOLER**

(75) Inventor: **John Maldonado**, Katy, TX (US)

(73) Assignee: **Igloo Products Corp.**, Houston, TX (US)

(\*\*) Term: **14 Years**

(21) Appl. No.: **29/236,298**

(22) Filed: **Aug. 15, 2005**

**Related U.S. Application Data**

(62) Division of application No. 29/207,768, filed on Jun. 17, 2004.

(51) **LOC (8) Cl.** ..... **07-01**

(52) **U.S. Cl.** ..... **D7/607**

(58) **Field of Classification Search** ..... D7/605-608, D7/709, 710; D3/273, 276, 283-287, 289; 220/915.2, 592.2, 592.24, 592.25, 915.1; 62/457.1-457.7, 371, 372; 383/97, 110, 113  
See application file for complete search history.

(56) **References Cited**

**U.S. PATENT DOCUMENTS**

2,960,136	A	*	11/1960	Ziff	.....	383/110
3,139,179	A	*	6/1964	Cadotte	.....	206/549
D359,200	S	*	6/1995	Gowin	.....	D7/606
D412,269	S	*	7/1999	Wyant	.....	D7/709
D414,379	S	*	9/1999	Haberkorn	.....	D7/607
D431,755	S	*	10/2000	Worley et al.	.....	D7/607

6,234,677	B1	5/2001	Mogil	.....	383/110
6,238,091	B1	5/2001	Mogil	.....	383/110
6,247,328	B1	6/2001	Mogil	.....	62/457.2
6,644,063	B1	11/2003	Mogil	.....	62/457.2

\* cited by examiner

*Primary Examiner*—Terry A. Wallace

(74) *Attorney, Agent, or Firm*—Howrey LLP

(57) **CLAIM**

The ornamental design for a softside cooler, as shown and described.

**DESCRIPTION**

FIG. 1 is a front and right side perspective view of a softside cooler in a closed position showing my new design;

FIG. 2 shows a front view of the softside cooler of FIG. 1 in a closed position;

FIG. 3 shows a back view of the softside cooler of FIG. 1 in a closed position;

FIG. 4 shows a right side view of the softside cooler of FIG. 1 in a closed position;

FIG. 5 shows a left side view of the softside cooler of FIG. 1 in a closed position;

FIG. 6 shows a top view of the softside cooler of FIG. 1 in a closed position;

FIG. 7 shows a bottom view of the softside cooler of FIG. 1; and,

FIG. 8 shows a front perspective view of the softside cooler of FIG. 1 in an open position.

**1 Claim, 5 Drawing Sheets**

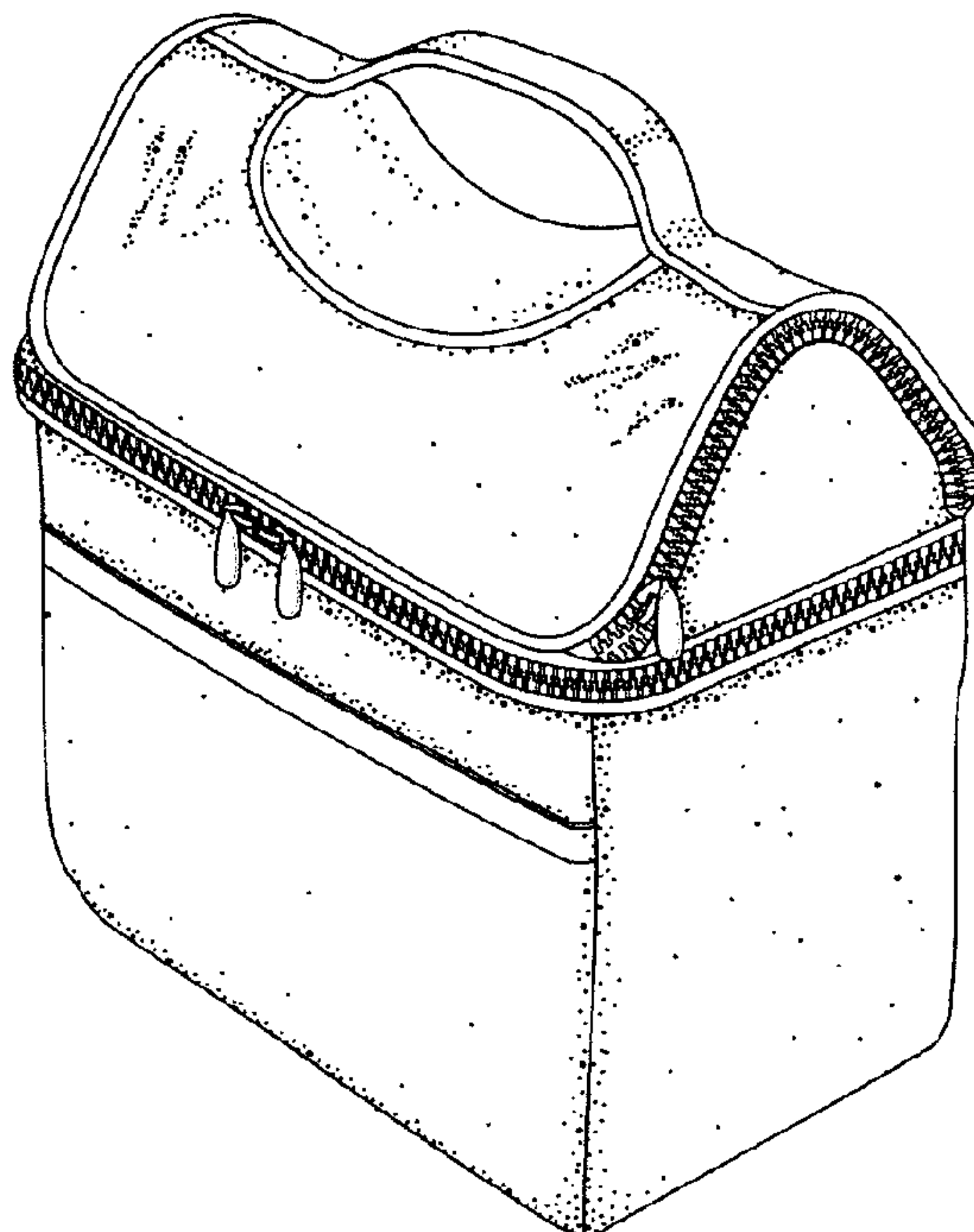

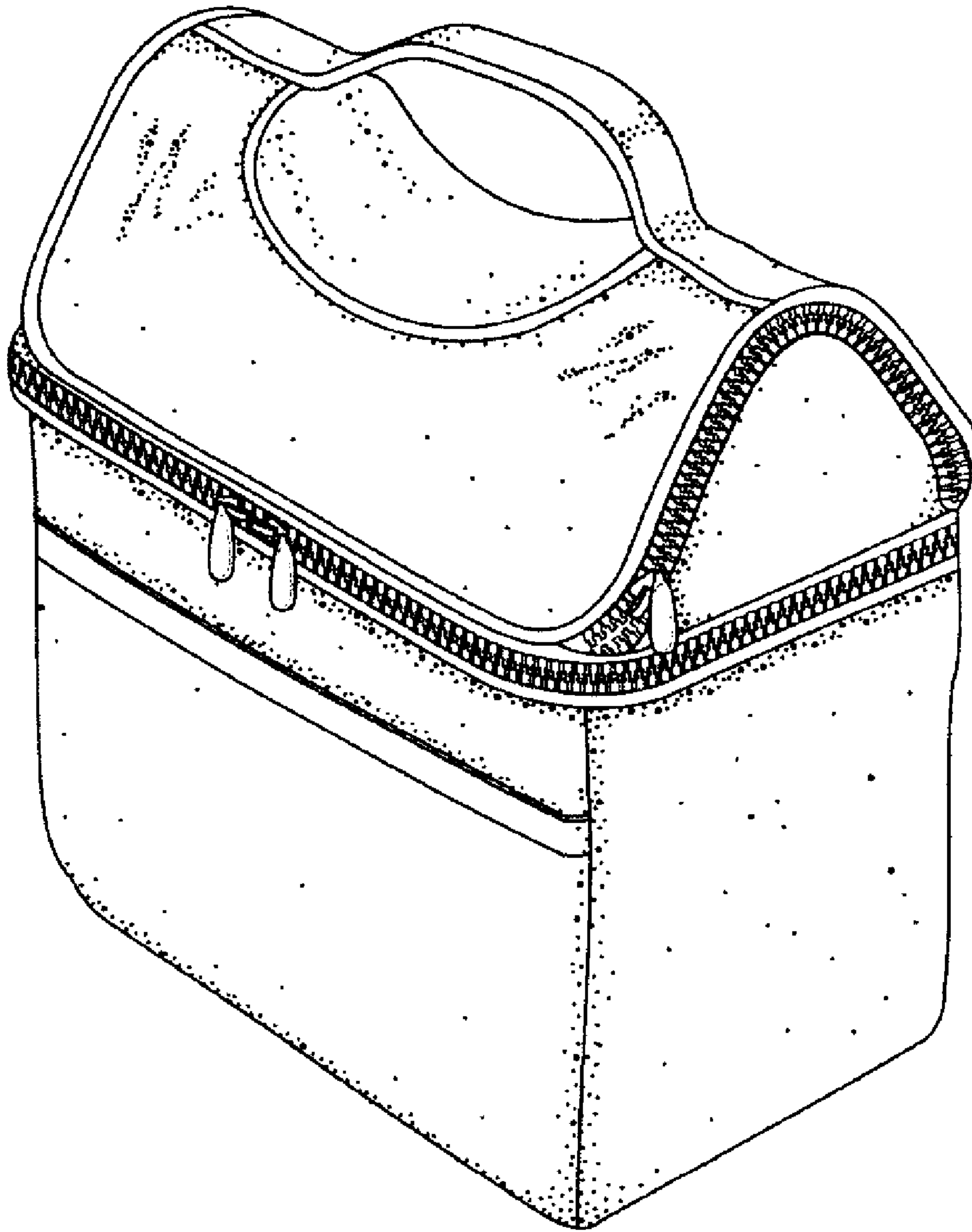

Figure 1

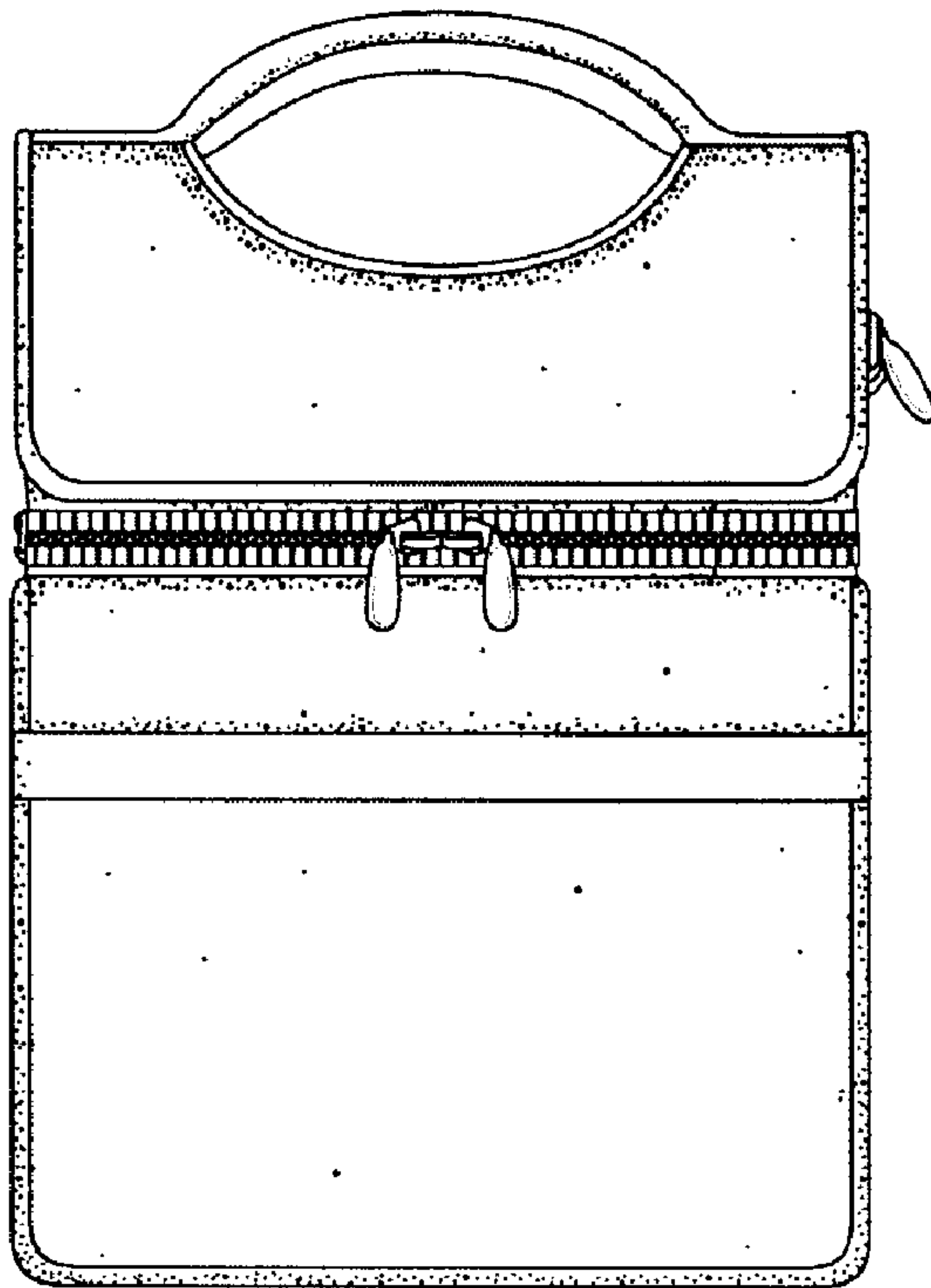

Figure 2

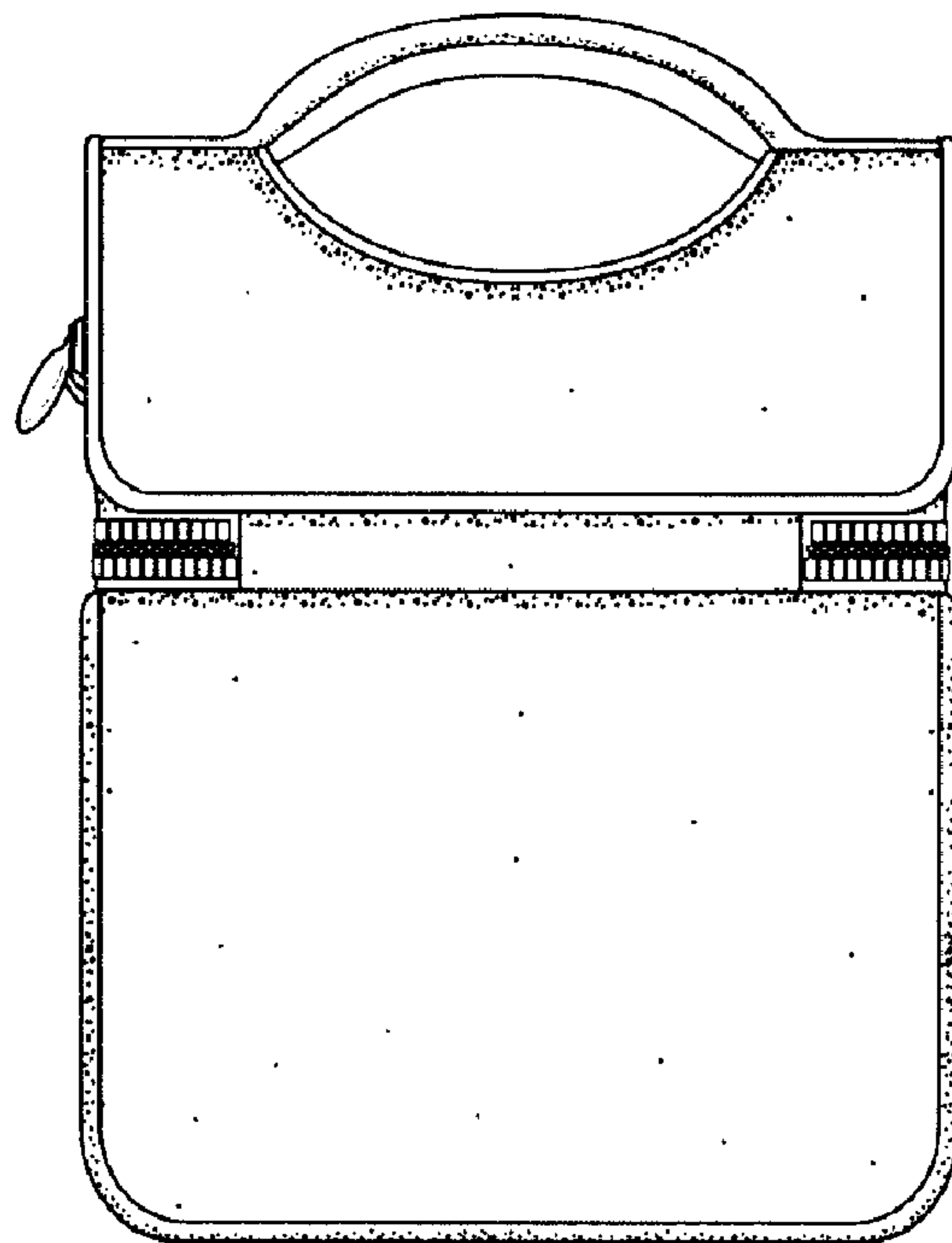

Figure 3

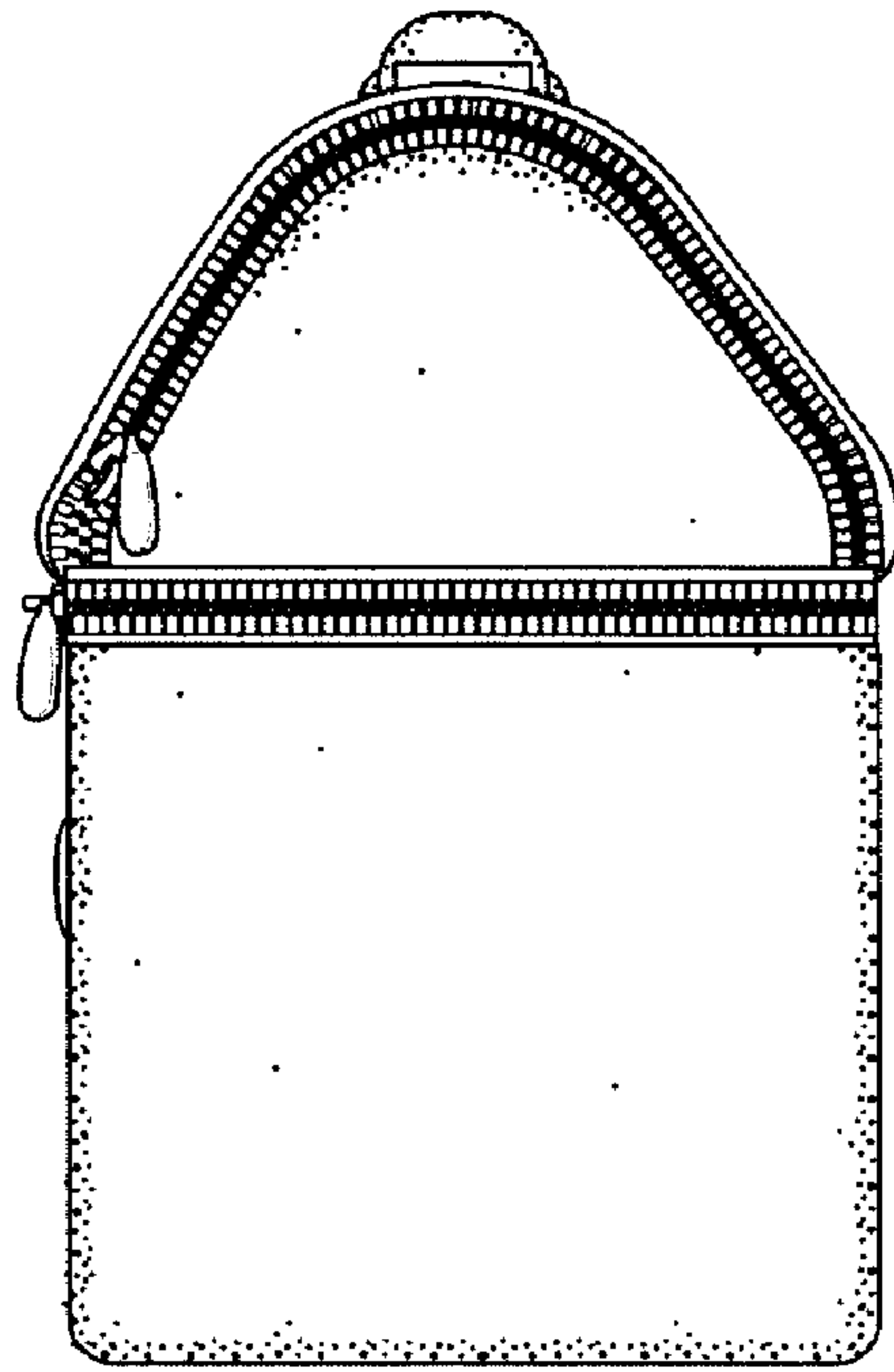

Figure 4

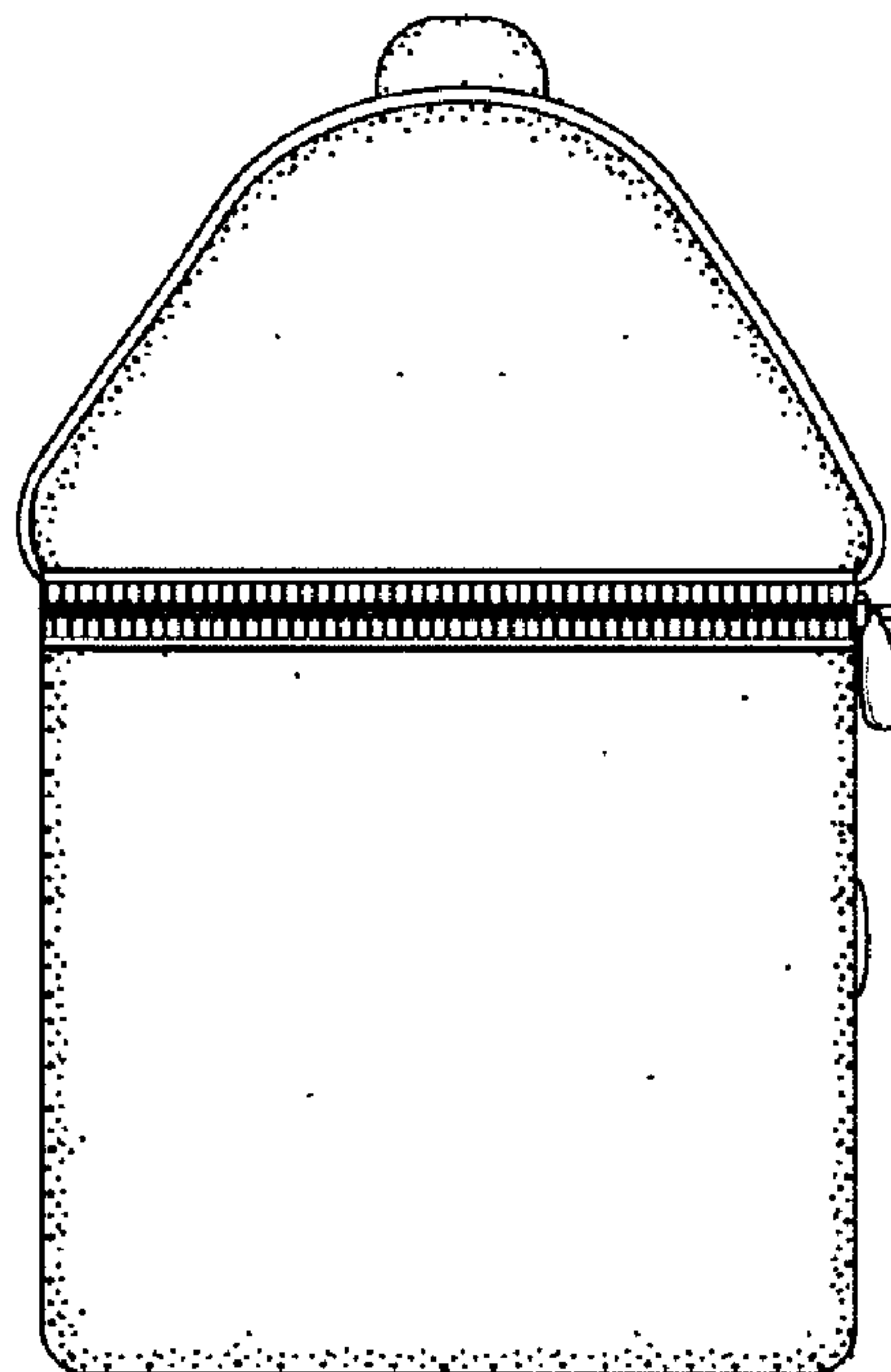

Figure 5

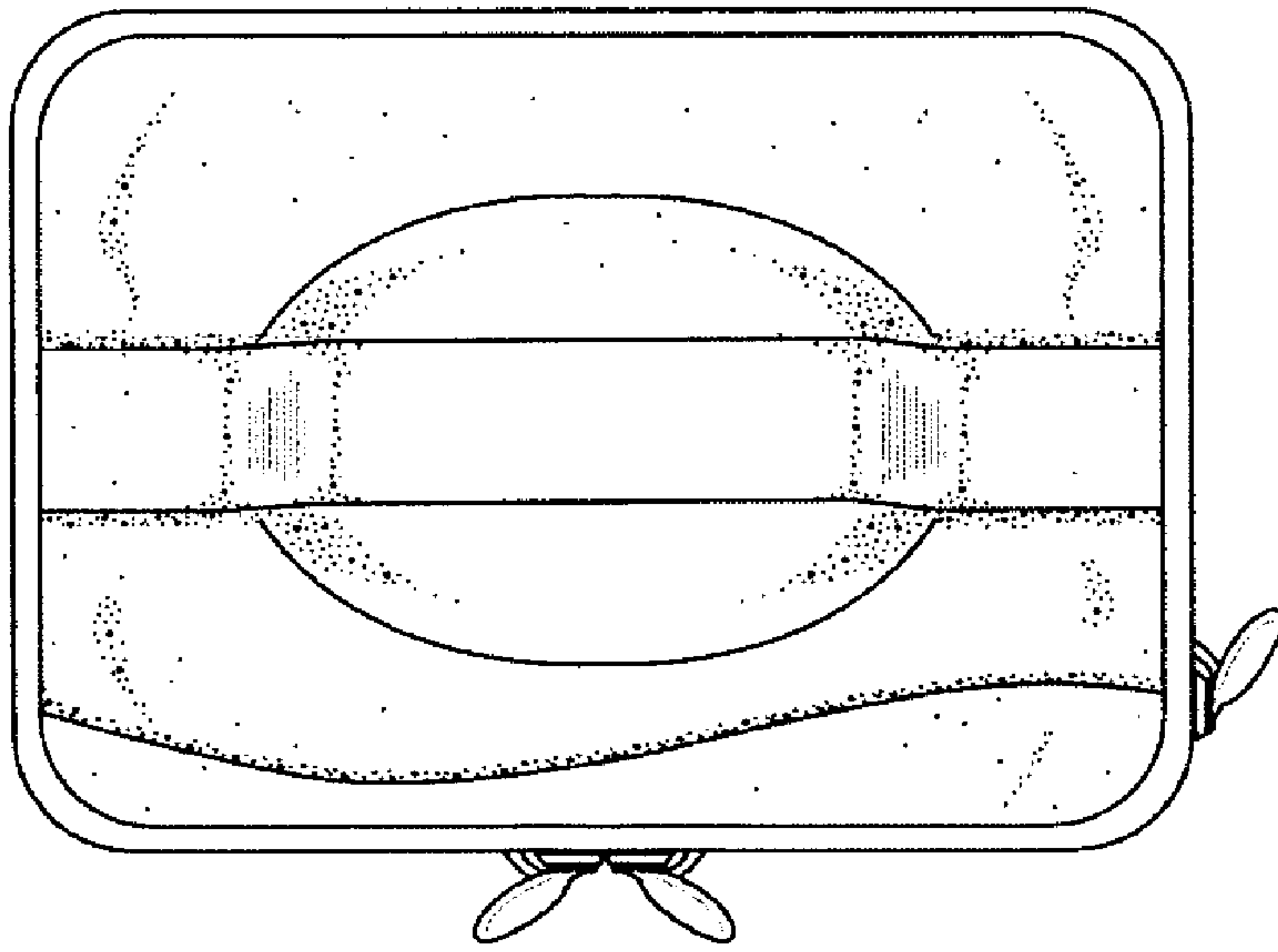

Figure 6

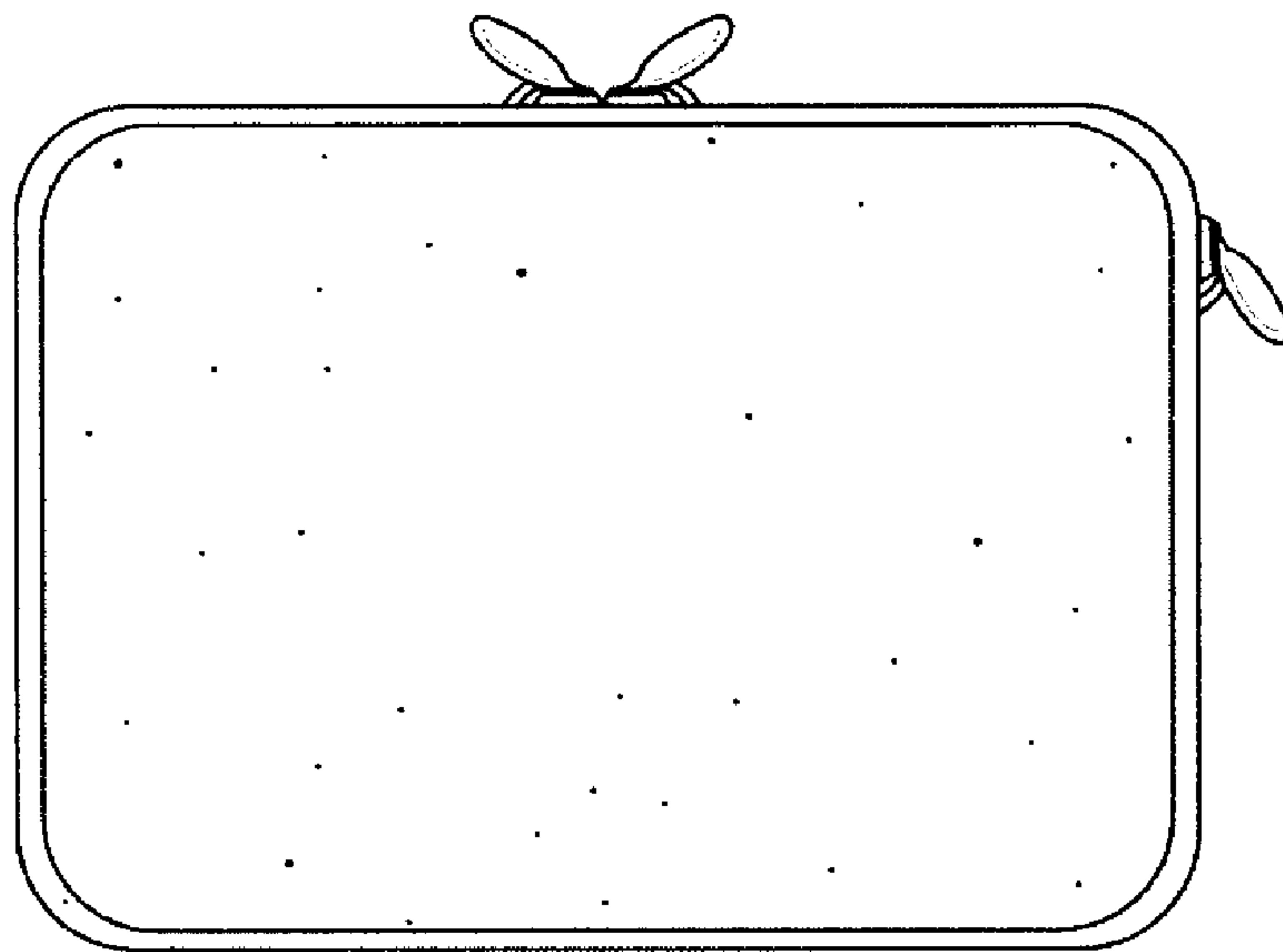

Figure 7



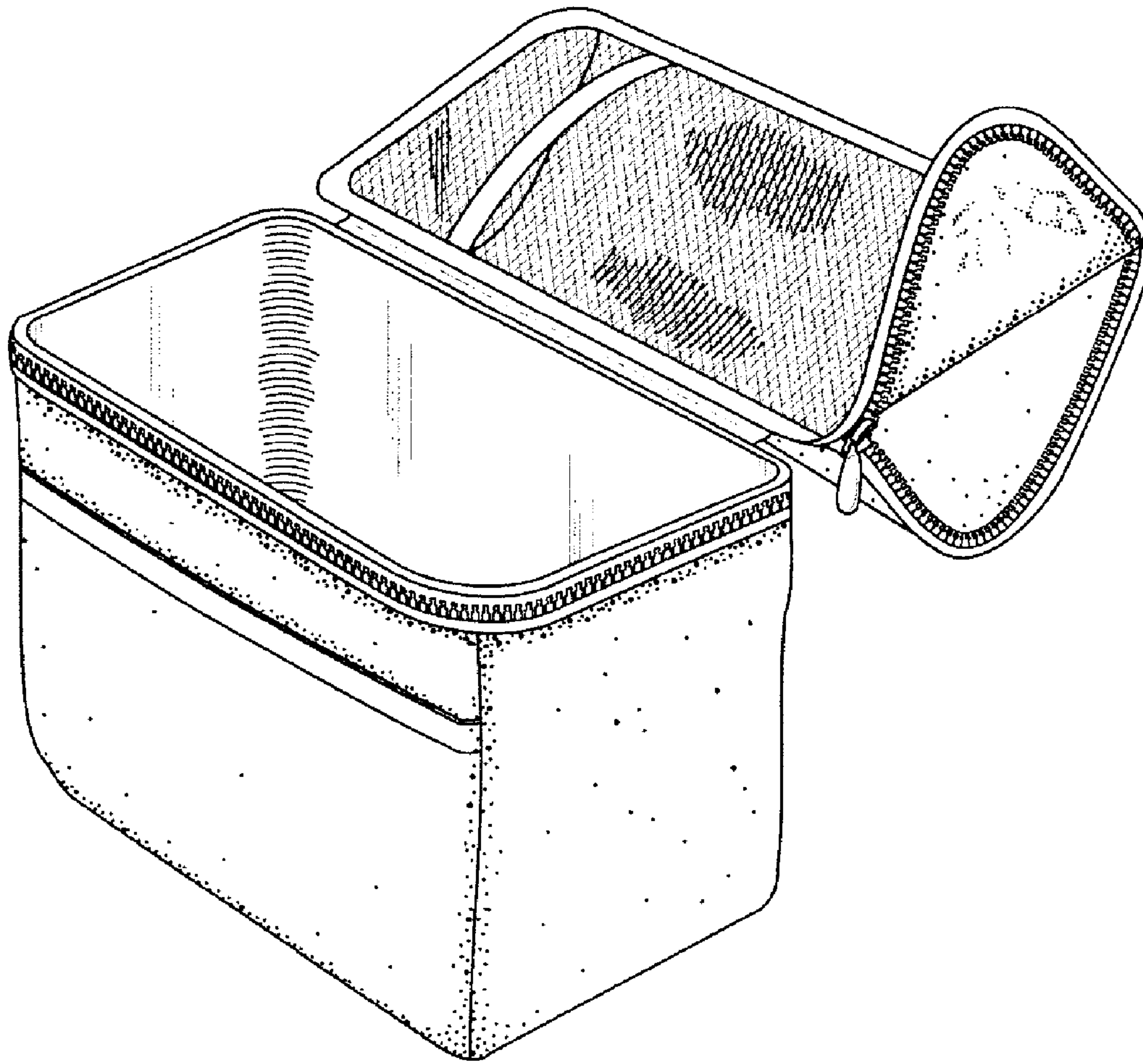

Figure 8