

US00D529337S

(12) **United States Design Patent**  
**Carreno et al.**

(10) **Patent No.:** **US D529,337 S**

(45) **Date of Patent:** **\*\* Oct. 3, 2006**

(54) **TRAVEL TUMBLER**

6,530,496 B1 \* 3/2003 Moran ..... 220/592.17  
D479,785 S \* 9/2003 Schuler ..... D7/629

(75) Inventors: **Alfredo Carreno**, Aurora, IL (US);  
**David Meyers**, Kaysville, UT (US)

\* cited by examiner

(73) Assignee: **Thermos L.L.C.**, Rolling Meadows, IL (US)

*Primary Examiner*—Terry A. Wallace

(74) *Attorney, Agent, or Firm*—Wood, Phillips, Katz, Clark & Mortimer

(\*\*) Term: **14 Years**

(57) **CLAIM**

(21) Appl. No.: **29/235,230**

The ornamental design for a travel tumbler, as shown and described.

(22) Filed: **Jul. 28, 2005**

**DESCRIPTION**

(51) **LOC (8) Cl.** ..... **07-01**

(52) **U.S. Cl.** ..... **D7/509; D7/608**

(58) **Field of Classification Search** ..... D7/629,  
D7/710, 605–608, 312–322, 509–511; 62/457.1–457.7,  
62/371, 372; 220/592.16, 592.17, 592.22,  
220/592.23, 592.27, 711, 714, 715, 703;  
215/12.1, 12.2, 13.1, 6, 392–398; 206/216,  
206/217, 223, 541

See application file for complete search history.

FIG. 1 is a perspective view from above and to the left of our travel tumbler design;

FIG. 2 is a perspective view from below and to the left of our travel tumbler design;

FIG. 3 is a left side elevation of our travel tumbler design, with the right side elevation being a mirror image of FIG. 3;

FIG. 4 is a front view of our travel tumbler design;

FIG. 5 is a back view of our travel tumbler design;

FIG. 6 is a top plan view of our travel tumbler design; and, FIG. 7 is a bottom view of our travel tumbler design.

The broken lines are for illustrative purposes only and form no part of the claimed design.

(56) **References Cited**

**U.S. PATENT DOCUMENTS**

3,765,559 A \* 10/1973 Sauey et al. .... 220/592.16

**1 Claim, 4 Drawing Sheets**

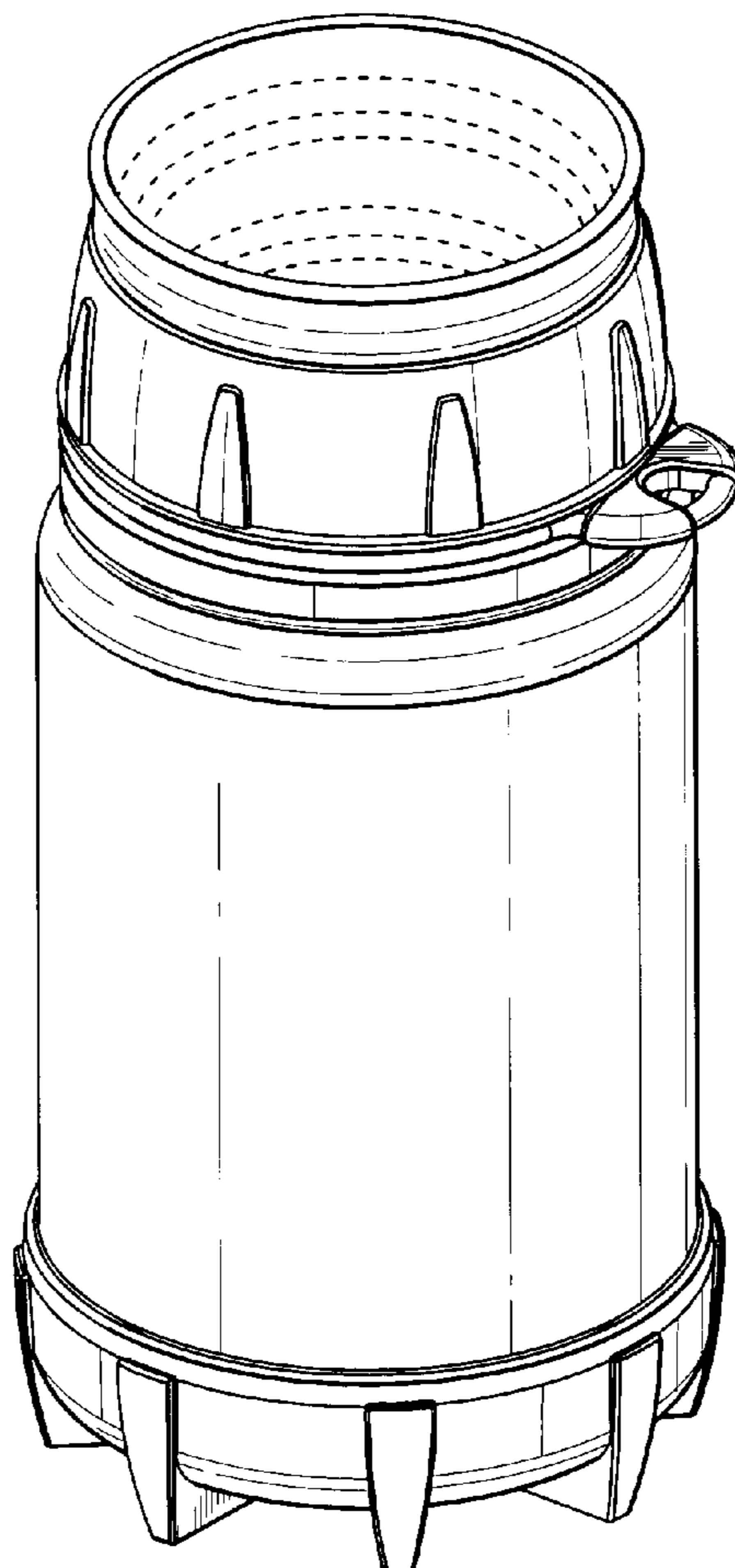

*Fig. 1*

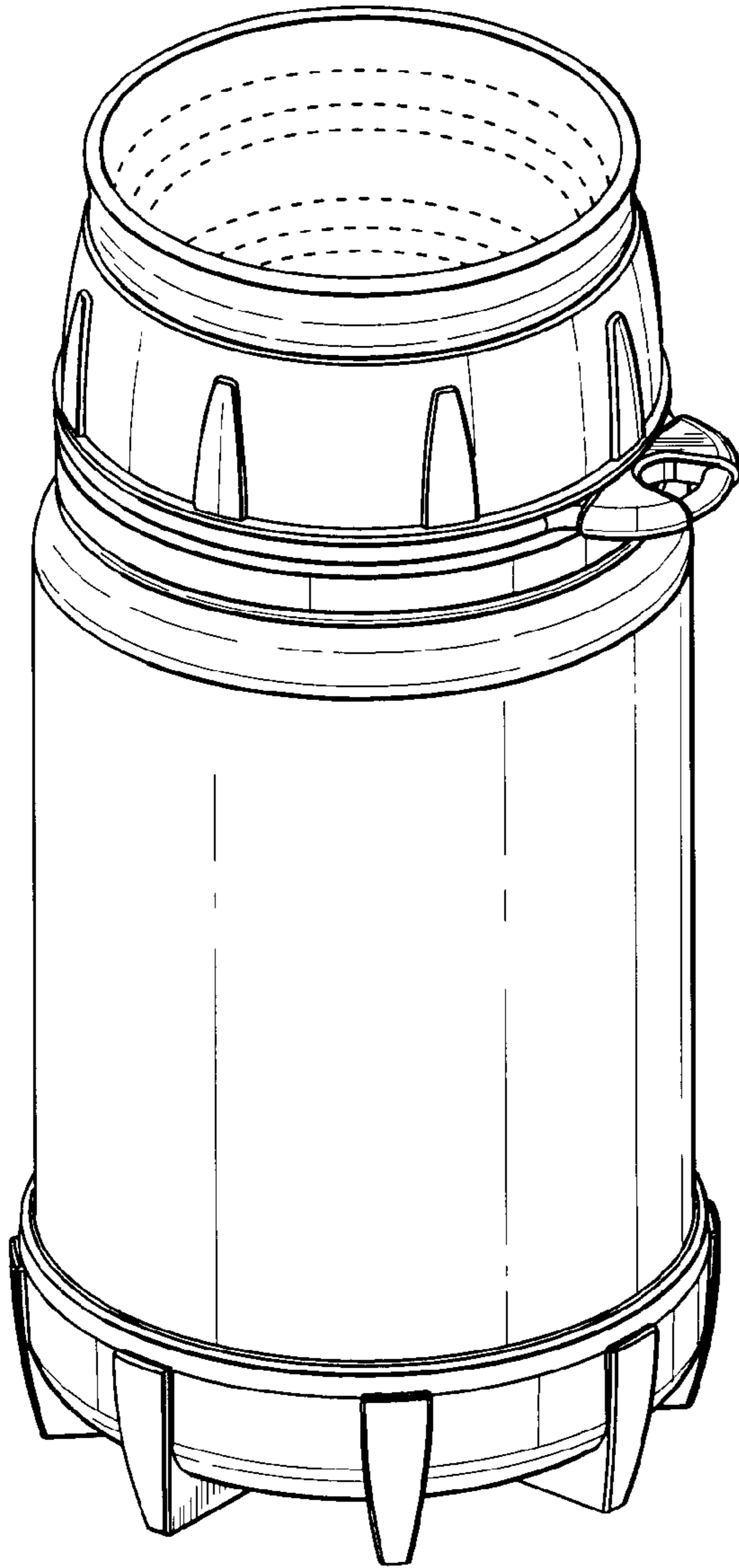

*Fig. 2*

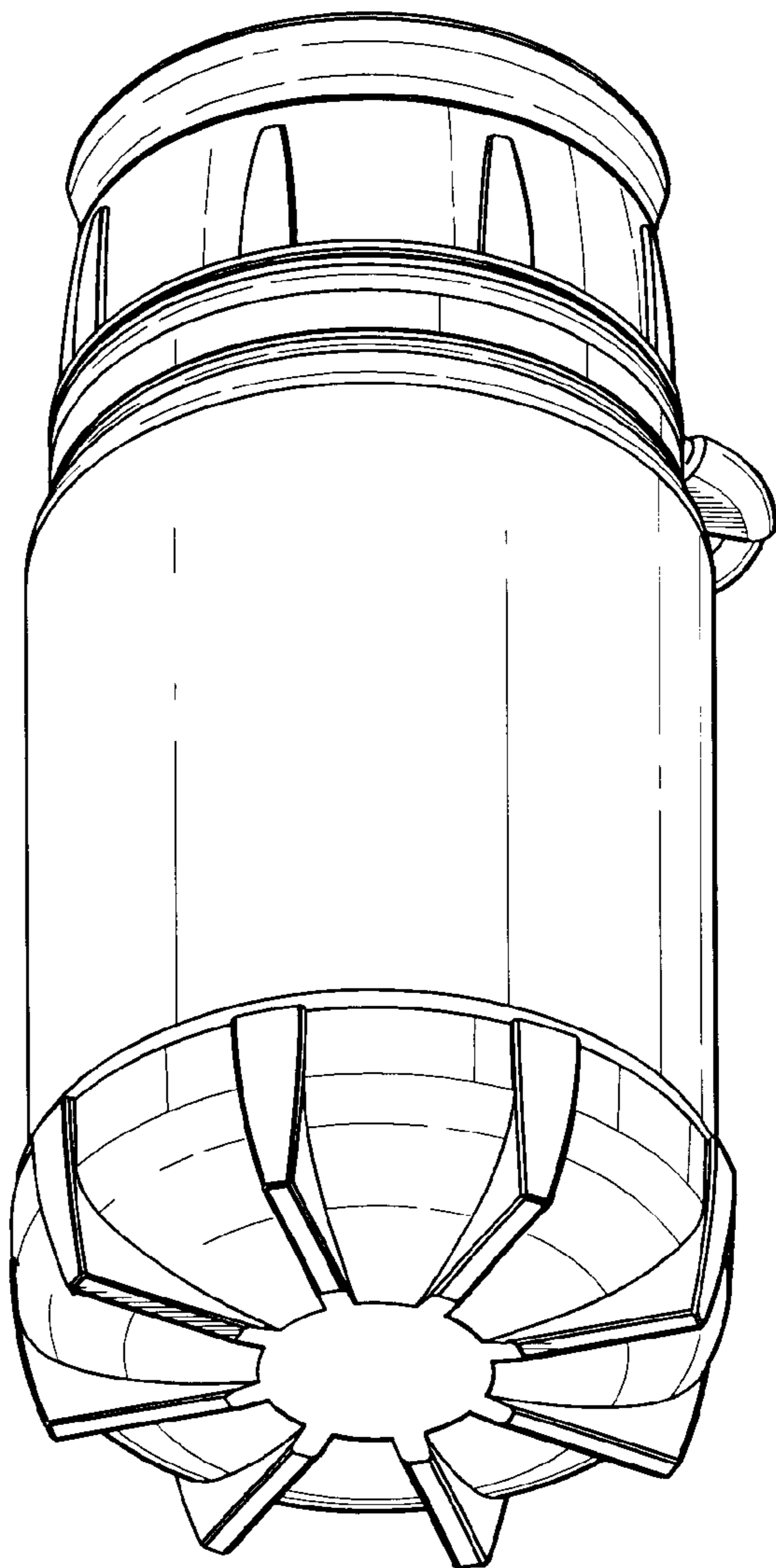

*Fig. 3*

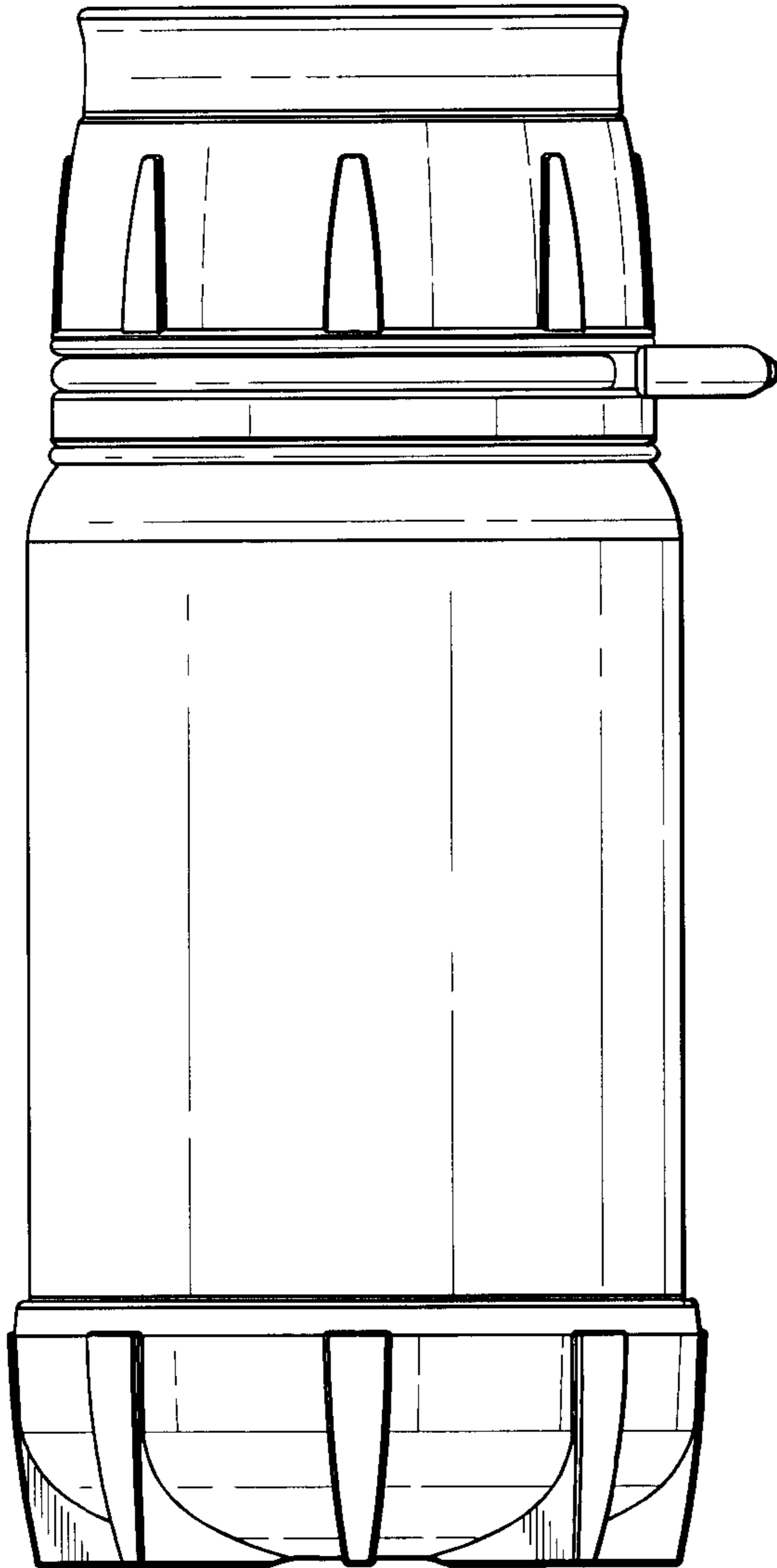

*Fig. 4*

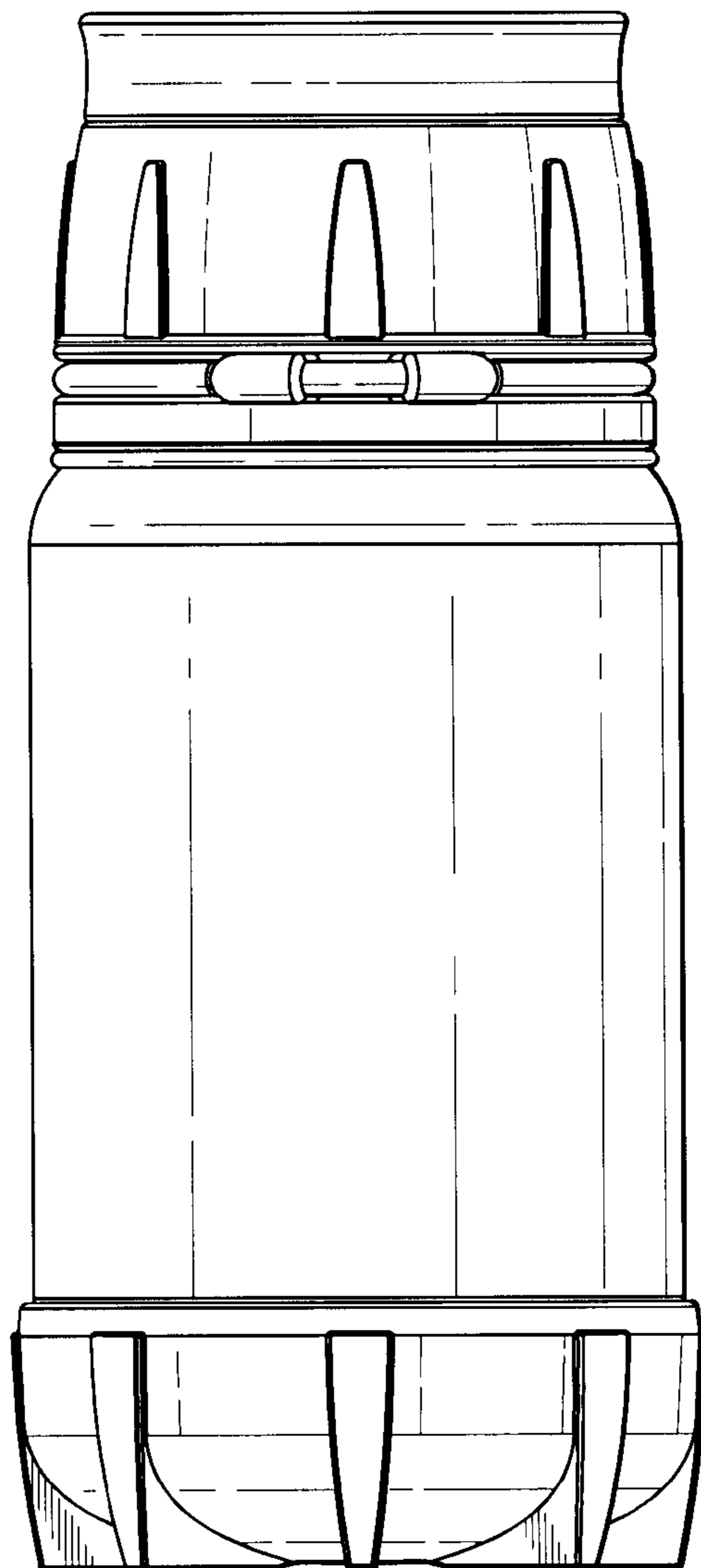

*Fig. 5*

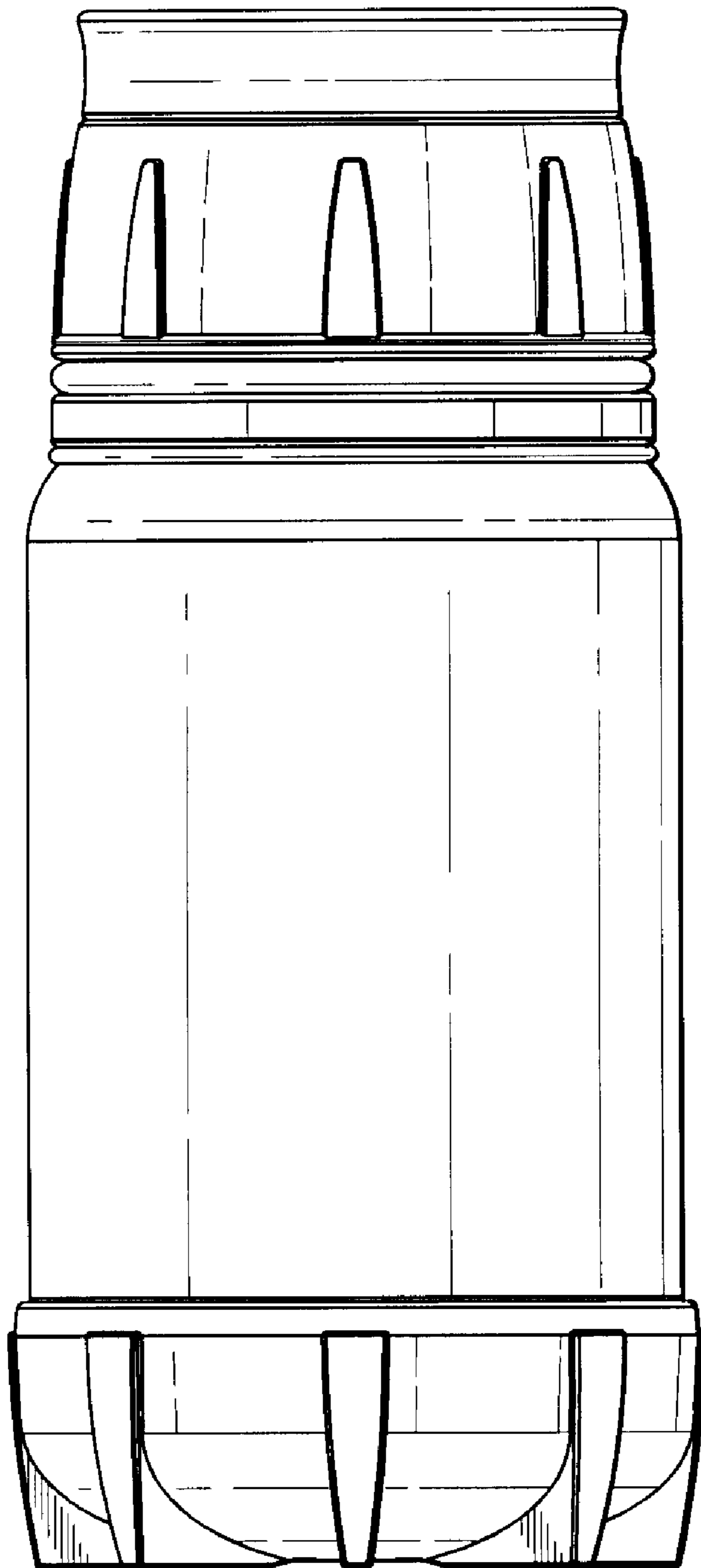

*Fig. 6*

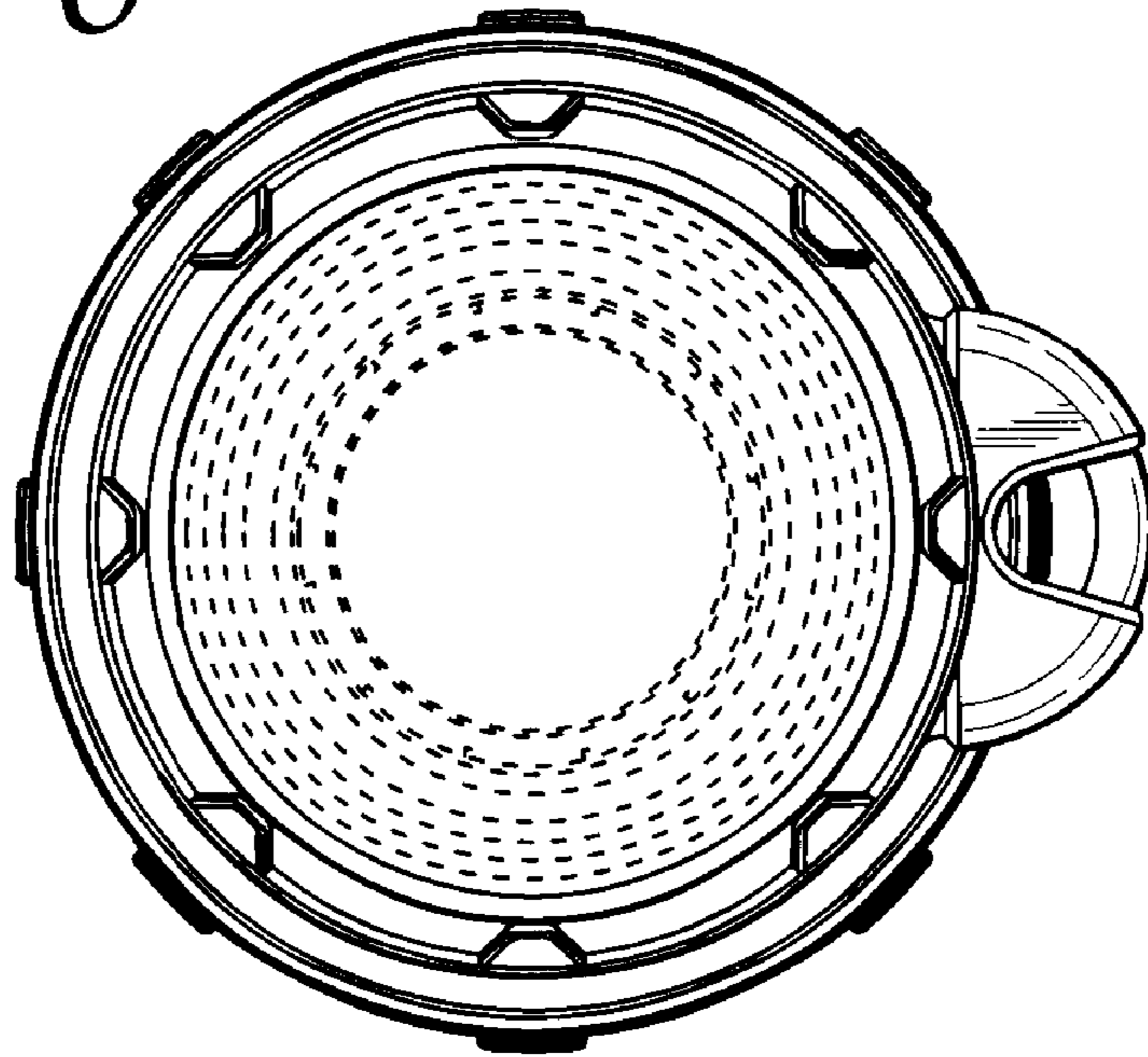

*Fig. 7*

