



US00D529254S

(12) **United States Design Patent**
Huguet

(10) **Patent No.:** **US D529,254 S**

(45) **Date of Patent:** **** Sep. 26, 2006**

(54) **PORTION OF A DRAWER OF A SERVICE CART**

(75) Inventor: **Marty Huguet**, Greer, SC (US)

(73) Assignee: **Professional Tool Products, LLC**, Greenville, SC (US)

(**) Term: **14 Years**

(21) Appl. No.: **29/219,940**

(22) Filed: **Dec. 23, 2004**

Related U.S. Application Data

(63) Continuation-in-part of application No. 29/211,199, filed on Aug. 12, 2004.

(51) **LOC (8) Cl.** **12-02**

(52) **U.S. Cl.** **D34/27**

(58) **Field of Classification Search** D34/12-27;
D6/414, 445, 510, 434, 446; 206/372; 312/351.3;
70/78; D8/301

See application file for complete search history.

(56) **References Cited**

U.S. PATENT DOCUMENTS

D105,241 S	*	7/1937	Erlanger	D6/397
2,329,767 A		9/1943	Jakeway		
2,525,208 A	*	10/1950	Clink	312/107
2,575,661 A		11/1951	Hickey		
2,697,244 A		12/1954	Lincke		
2,981,549 A		4/1961	Hotton		
D195,470 S	*	6/1963	Knoll	D6/494
D219,278 S	*	11/1970	Protzmann	D8/301
D224,492 S	*	8/1972	Inhelder	D6/446
D232,166 S	*	7/1974	Salsgiver	D34/19
3,997,218 A		12/1976	Wolf et al.		
4,120,549 A		10/1978	Bureau		
D253,031 S	*	10/1979	Gidseg	D8/301
D257,476 S	*	11/1980	Sirois	D8/316
D269,062 S	*	5/1983	Kain	D8/319
D278,769 S	*	5/1985	Sharpe	D6/414
D283,263 S		4/1986	Richey		
4,586,762 A		5/1986	Kennedy et al.		

4,880,248 A		11/1989	Elmer		
5,221,132 A		6/1993	Combs et al.		
D337,404 S		7/1993	Miles		
5,489,106 A		2/1996	Engelking et al.		
5,497,878 A	*	3/1996	Sandonato	206/372
5,588,659 A		12/1996	Boes et al.		
5,673,983 A		10/1997	Carlson et al.		

(Continued)

OTHER PUBLICATIONS

U.S. Appl. No. 10/746,412, filed Dec. 24, 2003; In re: Huguet, entitled *Service Cart With Protective Bumpers and Recessed Drawer Handles*.

U.S. Appl. No. 29/211,200, filed Aug. 12, 2004; In re: Huguet, entitled *Service Cart*.

Primary Examiner—Freda Nunn

Assistant Examiner—Kevin K. Rudzinski

(74) *Attorney, Agent, or Firm*—Alston & Bird LLP

(57) **CLAIM**

The ornamental design for a portion of a drawer of a service cart, as shown and described.

DESCRIPTION

FIG. 1 is a perspective view of a portion of a drawer of a service cart showing my new design;

FIG. 2 is a cross-section of the right side elevation view of the portion of a drawer of FIG. 1;

FIG. 3 is a front elevation view of the portion of a drawer of FIG. 1;

FIG. 4 is a top plan view of the portion of a drawer of FIG. 1;

FIG. 5 is a right side elevation view of the portion of a drawer of FIG. 1, the left side elevation view being a mirror image thereof; and,

FIG. 6 is a bottom plan view of the portion of a drawer of FIG. 1; the rear elevation view of the portion of a drawer of FIG. 1 is unornamented and forms no part of the claimed design of the portion of a drawer shown in FIG. 1.

The broken lines shown herein are for illustrative purposes only and form no part of the claimed design.

1 Claim, 5 Drawing Sheets

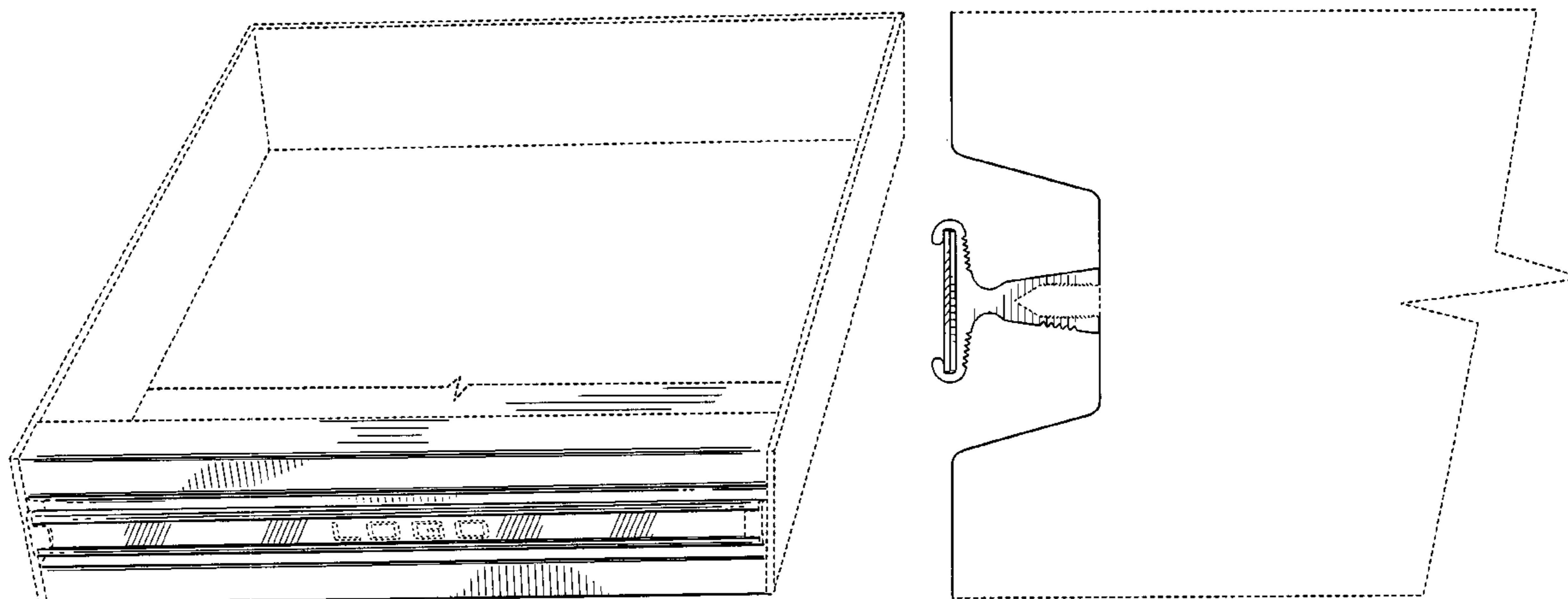

US D529,254 S

Page 2

U.S. PATENT DOCUMENTS			
5,720,535	A	2/1998	Mehman
5,857,757	A *	1/1999	Bieker et al. 312/351.3
5,913,582	A	6/1999	Coonan
D423,817	S	5/2000	Holcomb et al.
D423,818	S	5/2000	Holcomb et al.
D427,807	S	7/2000	Holcomb et al.
D435,180	S *	12/2000	Richard D6/445
6,264,219	B1	7/2001	Smith
6,374,649	B1 *	4/2002	Holcomb et al. 70/78
6,578,938	B1	6/2003	Norman et al.
D477,479	S *	7/2003	Henderson et al. D6/510
D477,724	S *	7/2003	Bishop D6/434
2001/0035702	A1	11/2001	Murphy et al.
2003/0155729	A1	8/2003	Chen
			* cited by examiner

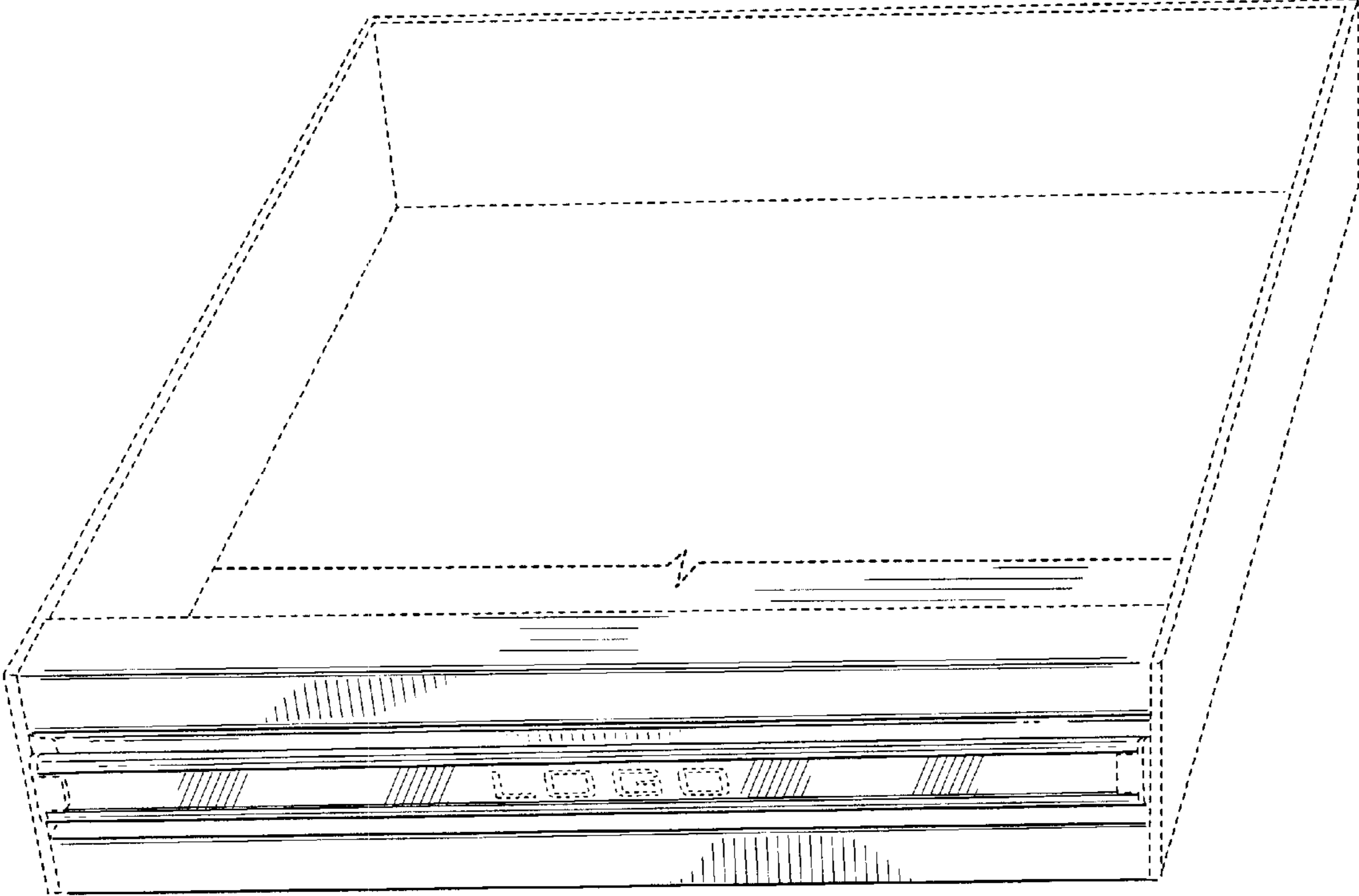

FIG. 1

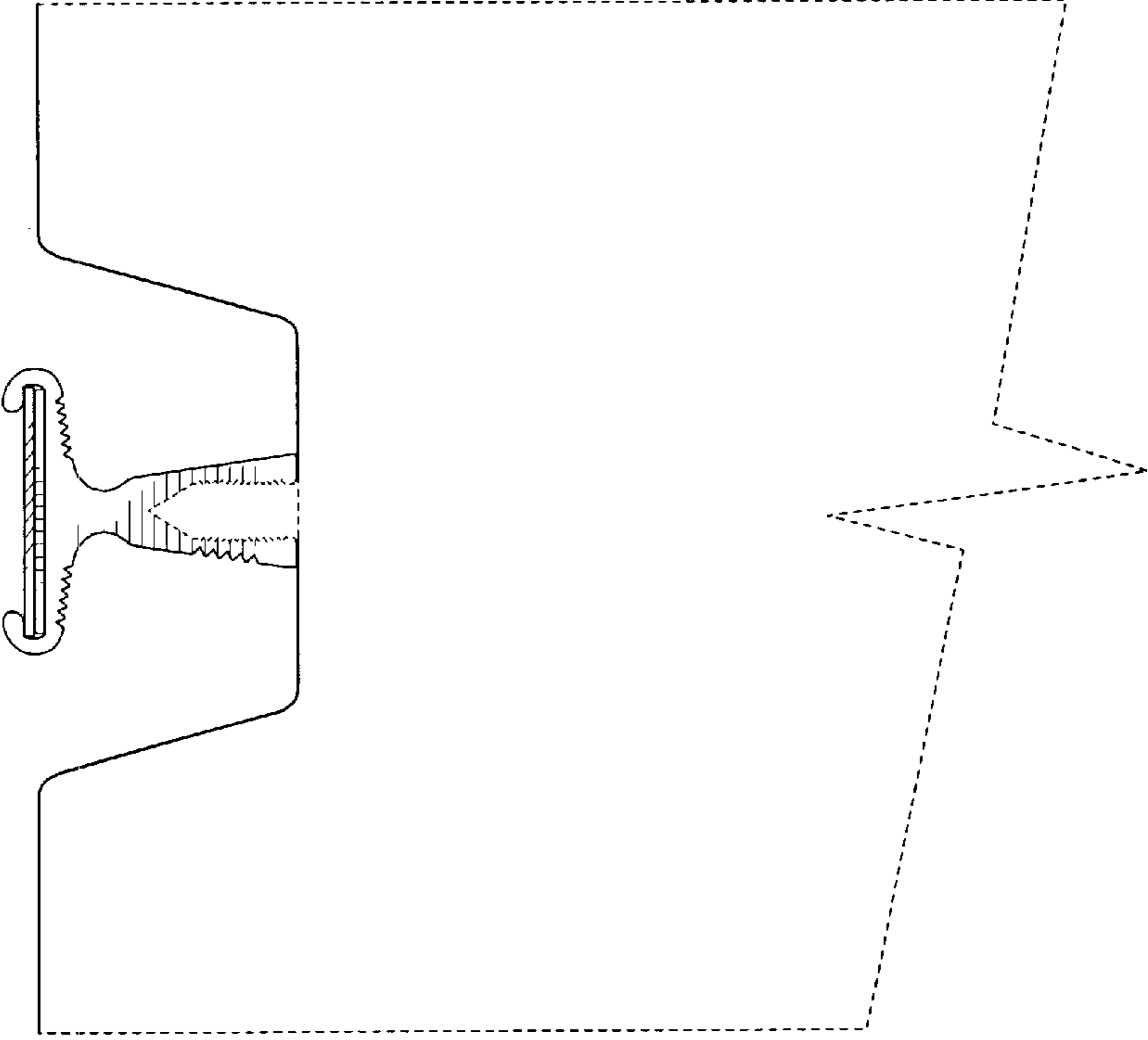

FIG. 2

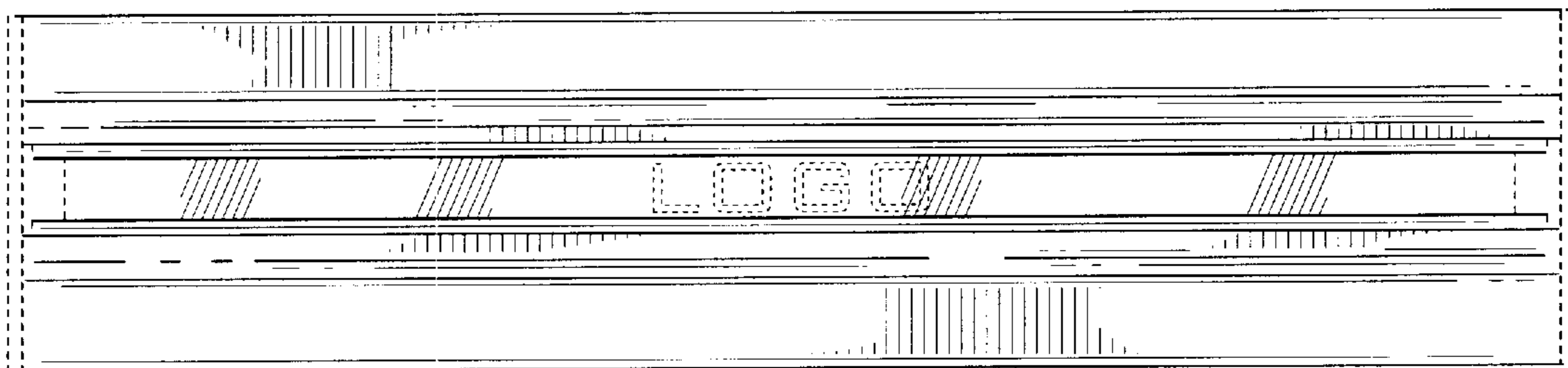

FIG. 3

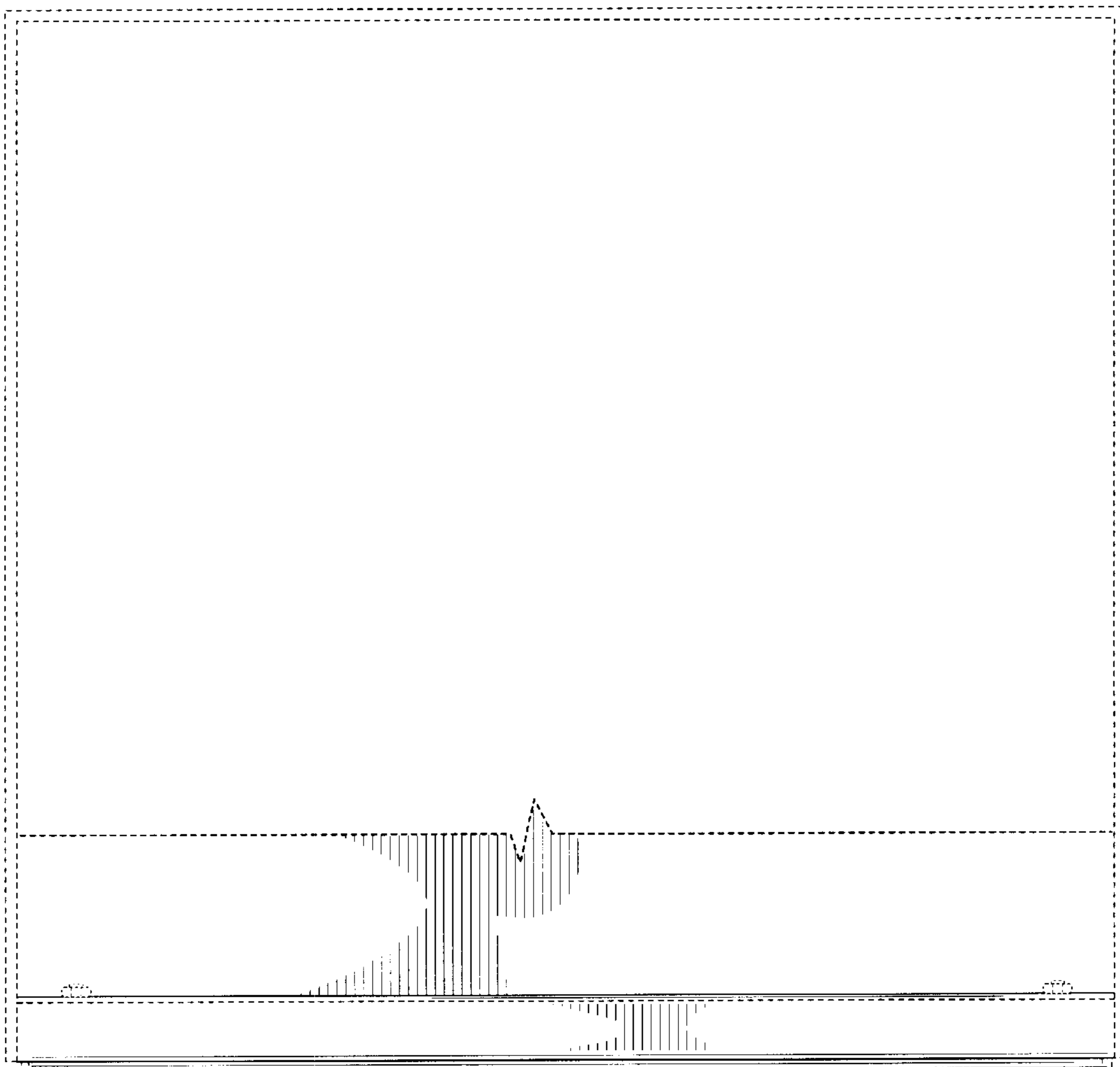

FIG. 4

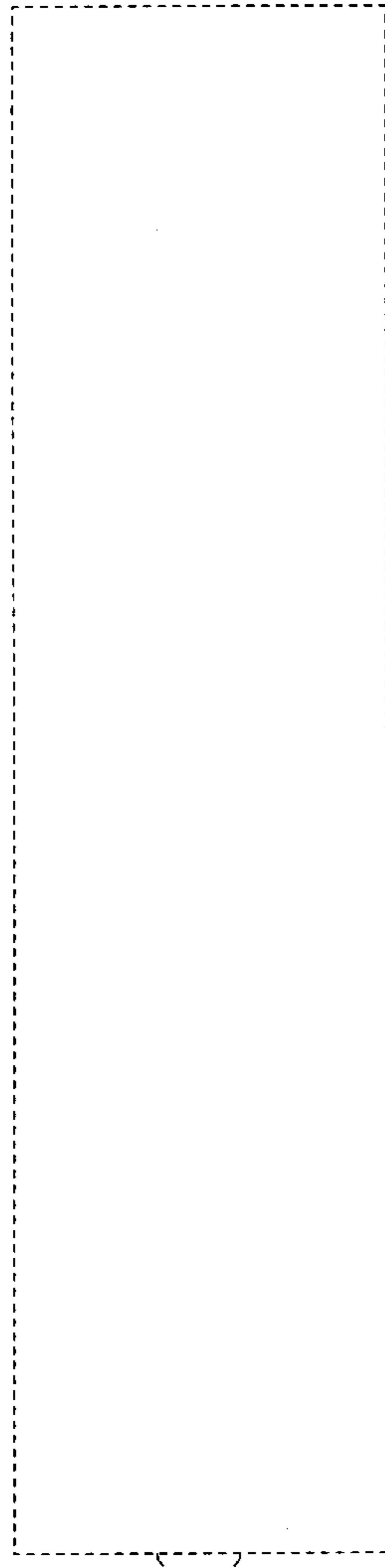

FIG. 5

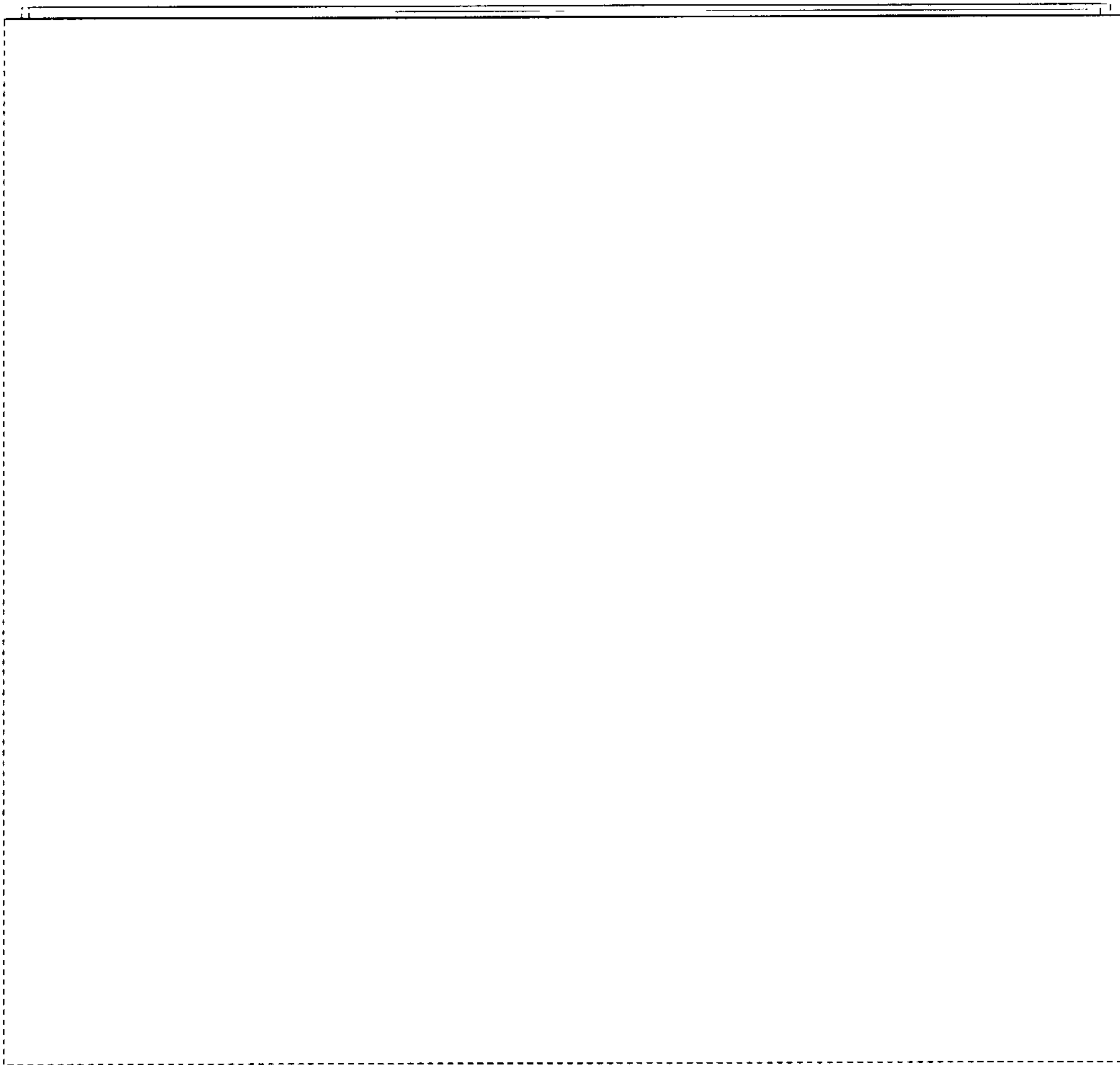

FIG. 6