



US00D529192S

(12) **United States Design Patent**
Whalen

(10) **Patent No.:** **US D529,192 S**

(45) **Date of Patent:** **** Sep. 26, 2006**

(54) **BUS SHELTER**

(75) Inventor: **Paul L. Whalen**, New York, NY (US)

(73) Assignee: **JCDECAUX SA**, Plaisir (FR)

(**) Term: **14 Years**

(21) Appl. No.: **29/230,154**

(22) Filed: **May 18, 2005**

(30) **Foreign Application Priority Data**

Mar. 9, 2005 (FR) 04 5591

(51) **LOC (8) Cl.** **25-02**

(52) **U.S. Cl.** **D25/56**

(58) **Field of Classification Search** D25/56;
135/907, 87, 908; 52/36.2, 73, 79.1
See application file for complete search history.

(56) **References Cited**

U.S. PATENT DOCUMENTS

3,735,536 A * 5/1973 Bellasalma 52/73
3,762,109 A * 10/1973 Cohen 52/11

D336,136 S * 6/1993 Foster D25/1
5,363,608 A * 11/1994 Conlan 52/79.1
D412,993 S * 8/1999 Chipman et al. D25/56
D500,143 S * 12/2004 Moncho et al. D25/56

* cited by examiner

Primary Examiner—Doris Clark

(74) *Attorney, Agent, or Firm*—Stites & Harbison PLLC;
Douglas E. Jackson

(57) **CLAIM**

The ornamental design for an bus shelter, as shown and described.

DESCRIPTION

FIG. 1 is a front elevational view of bus shelter incorporating the design of the present invention;
FIG. 2 is a rear elevational view thereof;
FIG. 3 is a right side elevational view thereof;
FIG. 4 is a left side elevational view thereof;
FIG. 5 is a top elevational view thereof; and,
FIG. 6 is a front perspective view thereof.

1 Claim, 6 Drawing Sheets

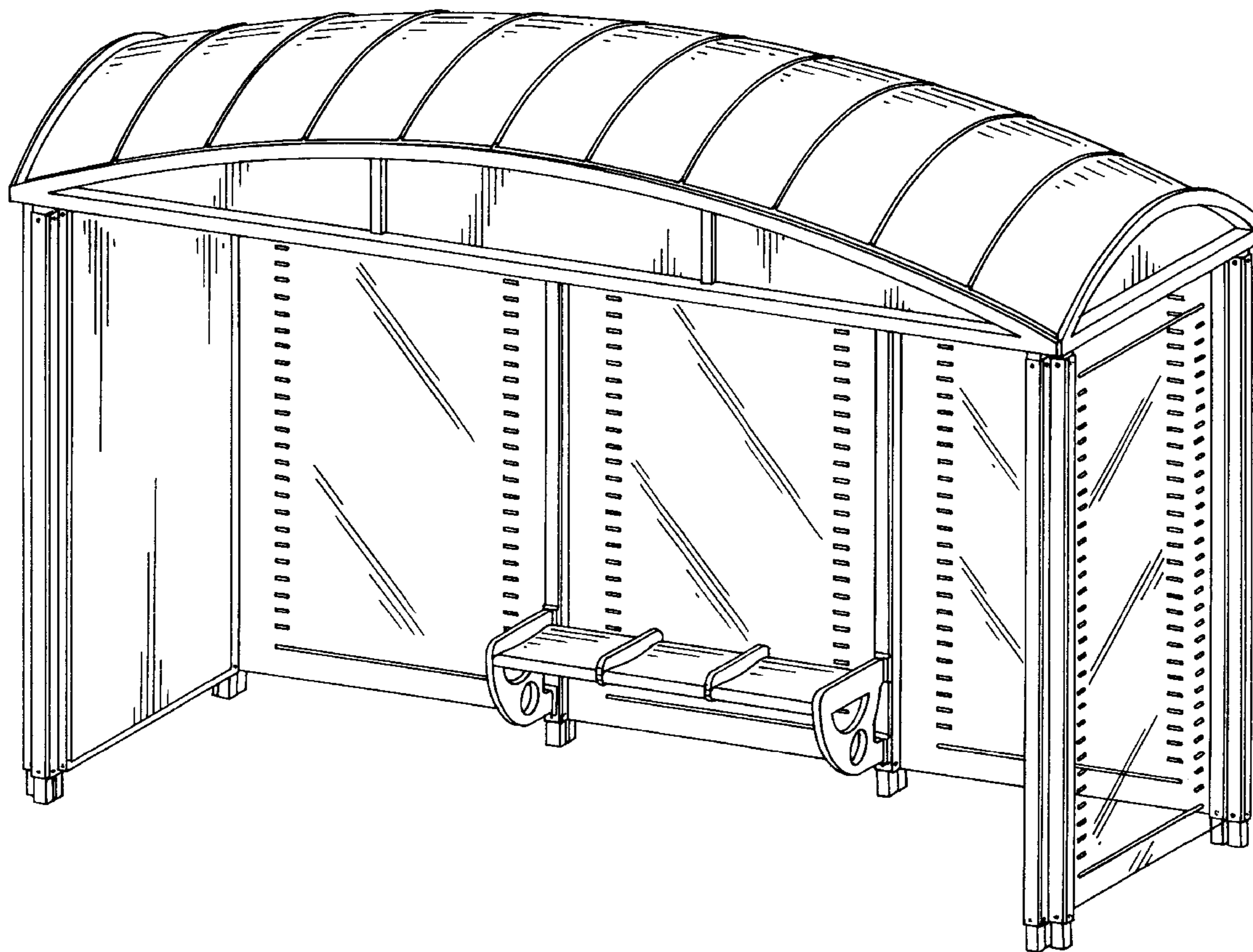

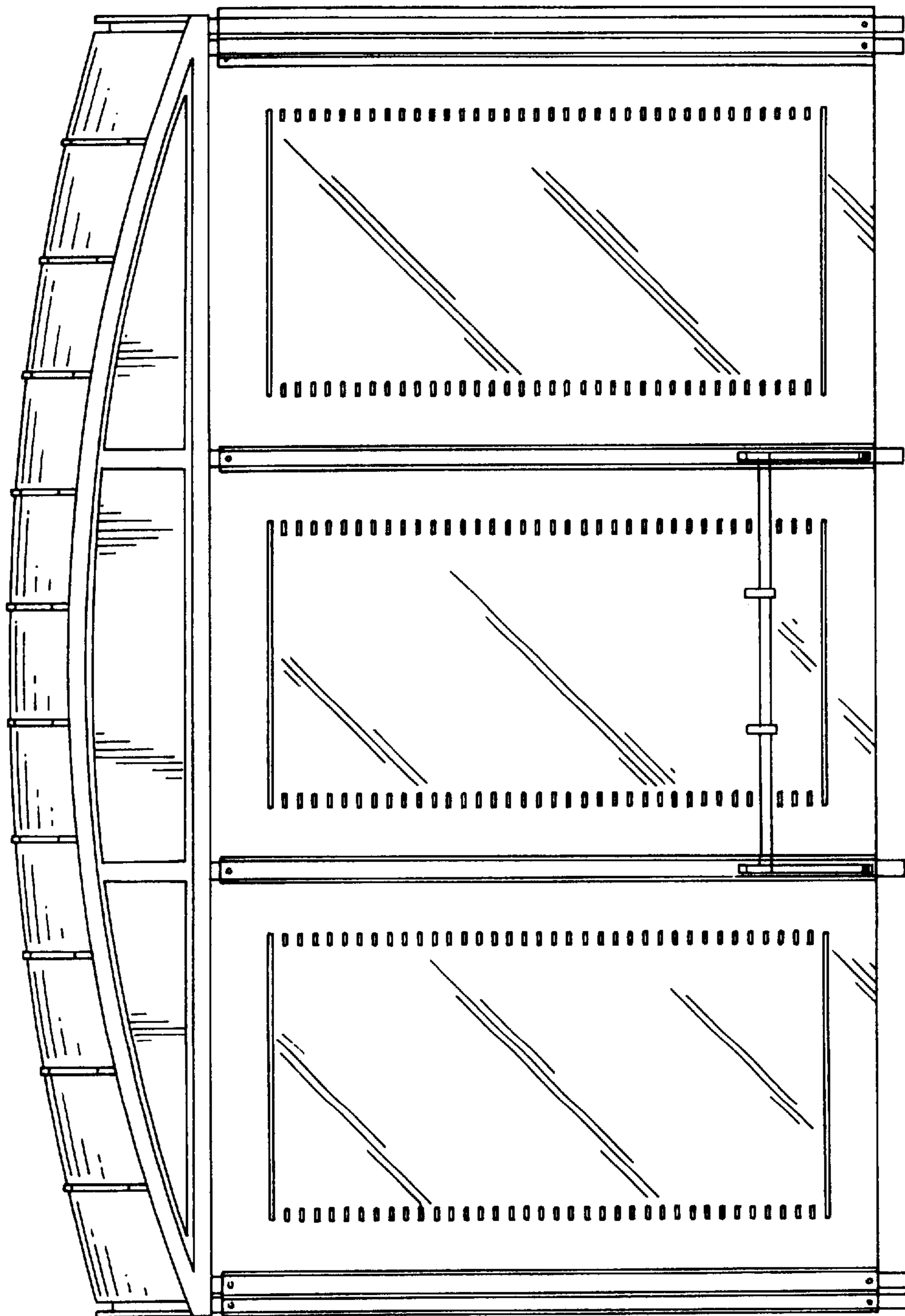

FIG. 1

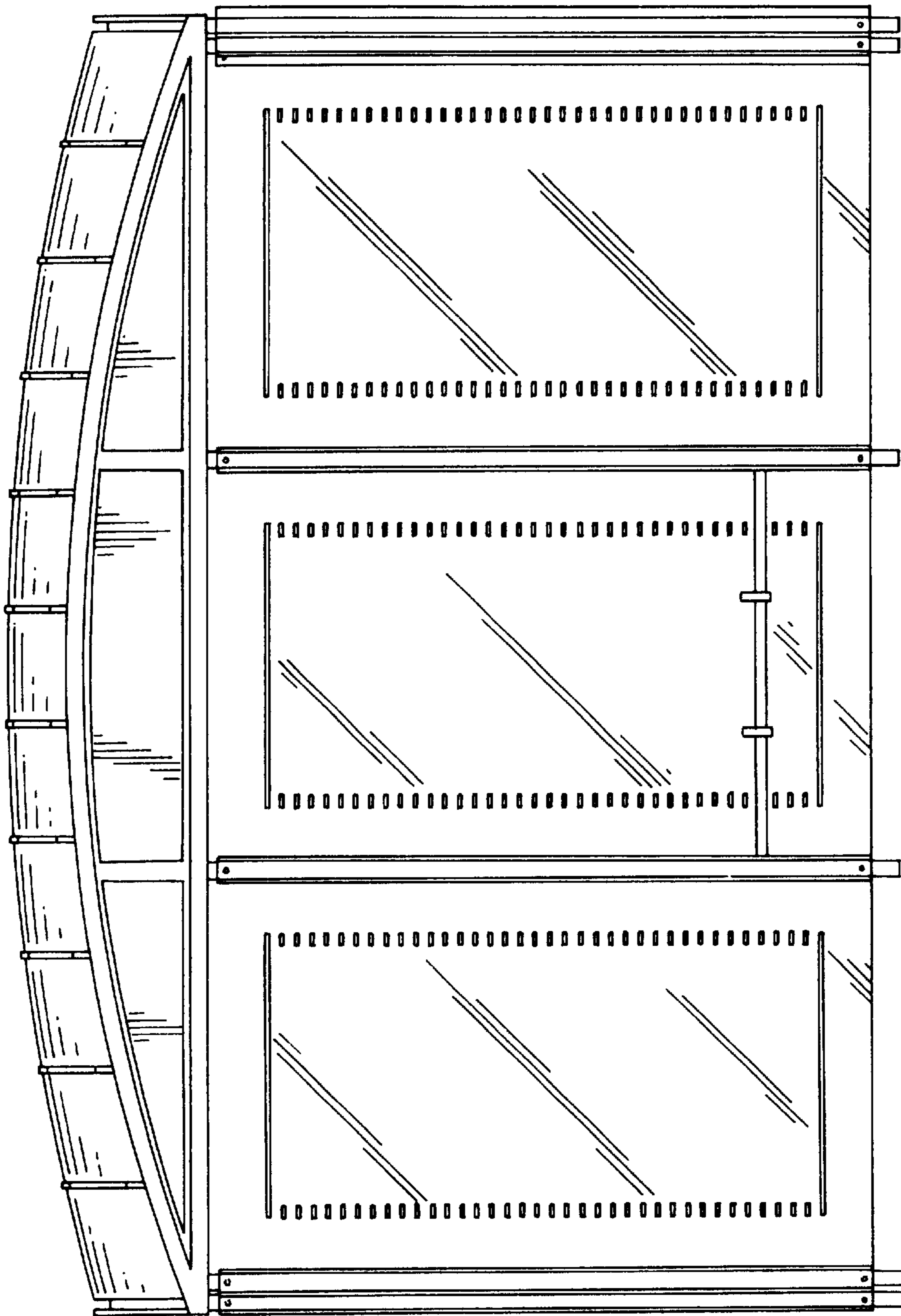

FIG. 2

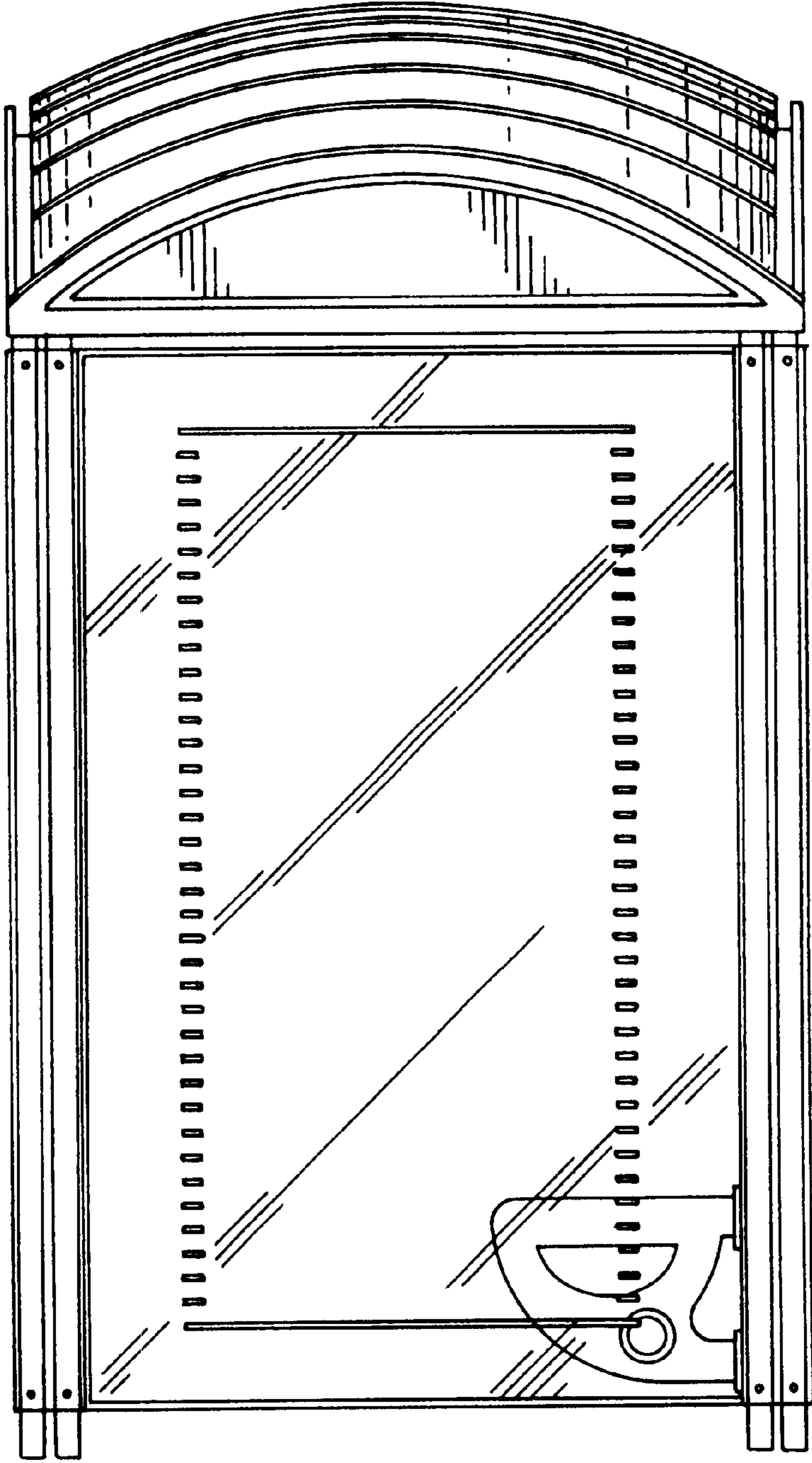

FIG. 3

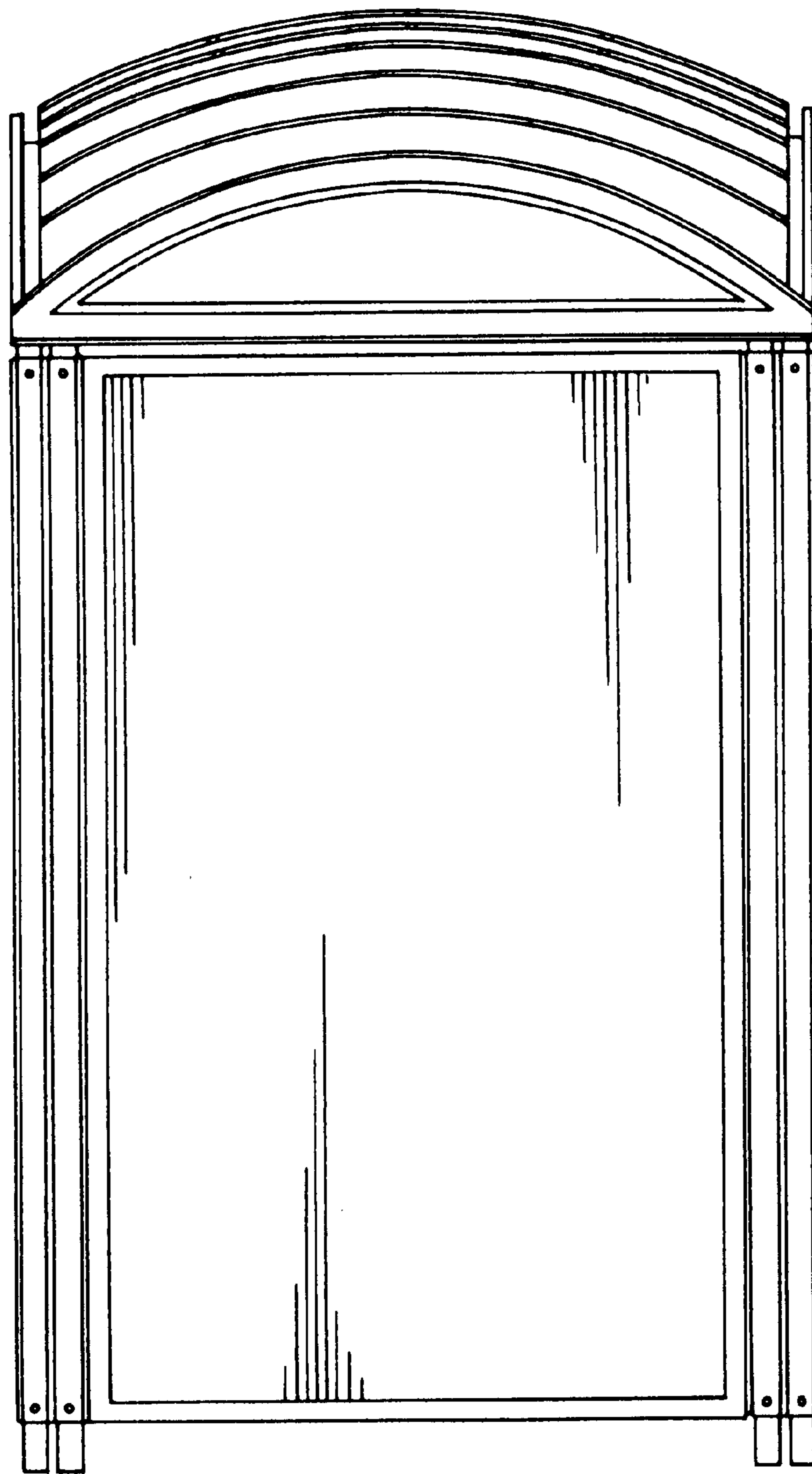

FIG. 4

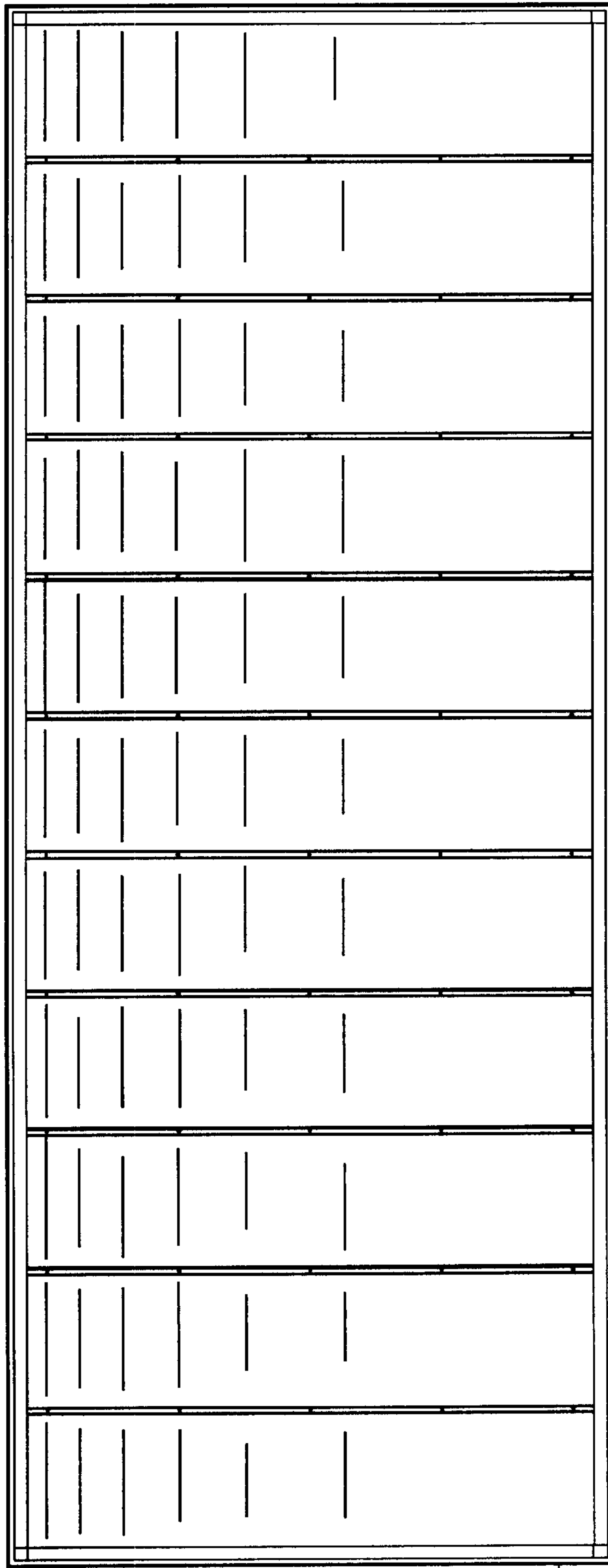

FIG. 5

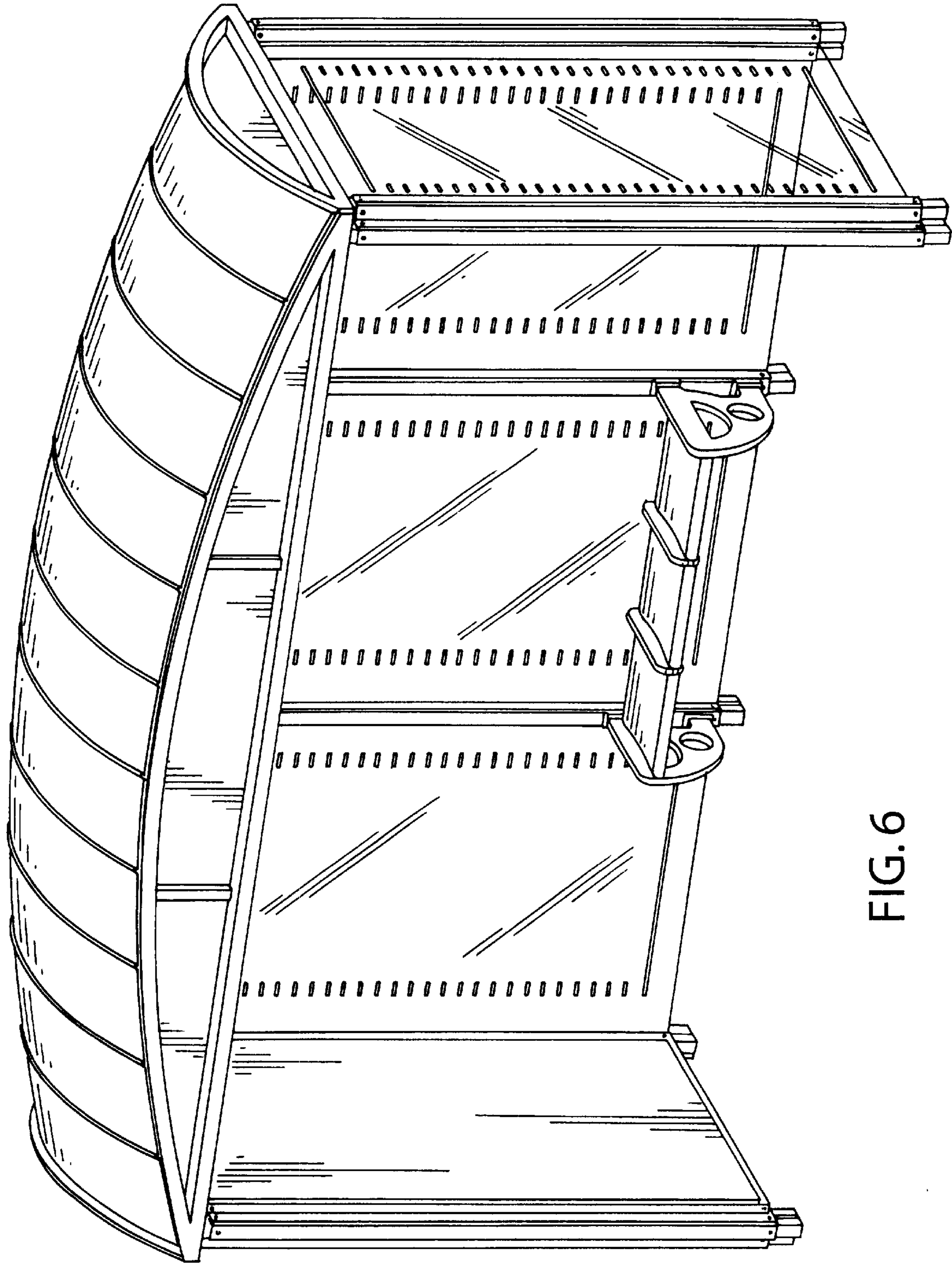

FIG. 6

UNITED STATES PATENT AND TRADEMARK OFFICE
CERTIFICATE OF CORRECTION

PATENT NO. : Des. 529,192 S
APPLICATION NO. : 29/230154
DATED : September 26, 2006
INVENTOR(S) : Whalen

Page 1 of 1

It is certified that error appears in the above-identified patent and that said Letters Patent is hereby corrected as shown below:

On the Title page under data section (30) **Foreign Application Priority Data:**
change "Mar. 9, 2005" to -- Nov. 18, 2004 --.

Signed and Sealed this

Seventeenth Day of April, 2007

A handwritten signature in black ink on a light gray dotted background. The signature reads "Jon W. Dudas" in a cursive style.

JON W. DUDAS

Director of the United States Patent and Trademark Office