



US00D529159S

(12) **United States Design Patent**
Howansky et al.

(10) **Patent No.:** **US D529,159 S**

(45) **Date of Patent:** **** Sep. 26, 2006**

(54) **VAPORIZER**

(75) Inventors: **Andrew Howansky**, Copake Falls, NY (US); **Stephen Russak**, Fort Lee, NJ (US); **Christopher Craig**, New York, NY (US); **Linda Hotz**, New City, NY (US); **Zhijing Wang**, Clifton Park, NY (US); **Mark Prommel**, New York, NY (US); **Agnete Eng**, Brooklyn, NY (US)

(73) Assignee: **Kaz, Incorporated**, New York, NY (US)

(**) Term: **14 Years**

(21) Appl. No.: **29/221,445**

(22) Filed: **Jan. 14, 2005**

(51) **LOC (8) Cl.** **23-04**

(52) **U.S. Cl.** **D23/360**

(58) **Field of Classification Search** D23/360,
D23/356; 392/324, 333, 403

See application file for complete search history.

(56) **References Cited**

U.S. PATENT DOCUMENTS

D214,563 S * 7/1969 Katzman D23/360

D267,114 S * 11/1982 Lynch et al. D23/364
D355,961 S * 2/1995 Cunning D23/360
D374,923 S * 10/1996 Moore D23/360
D377,212 S * 1/1997 Moore D23/360
D425,975 S * 5/2000 Wolfe D23/356
D443,350 S * 6/2001 Delmenico et al. D23/360

* cited by examiner

Primary Examiner—Robin Webster

(74) *Attorney, Agent, or Firm*—Darby & Darby

(57) **CLAIM**

The ornamental design for a vaporizer, as shown and described.

DESCRIPTION

FIG. 1 is a front perspective view showing an embodiment of our new design;

FIG. 2 is a front elevation view thereof;

FIG. 3 is a left side elevation view, the right side being a mirror image thereof;

FIG. 4 is a rear elevation view thereof;

FIG. 5 is a top plan view thereof; and,

FIG. 6 is a bottom plan view thereof.

1 Claim, 3 Drawing Sheets

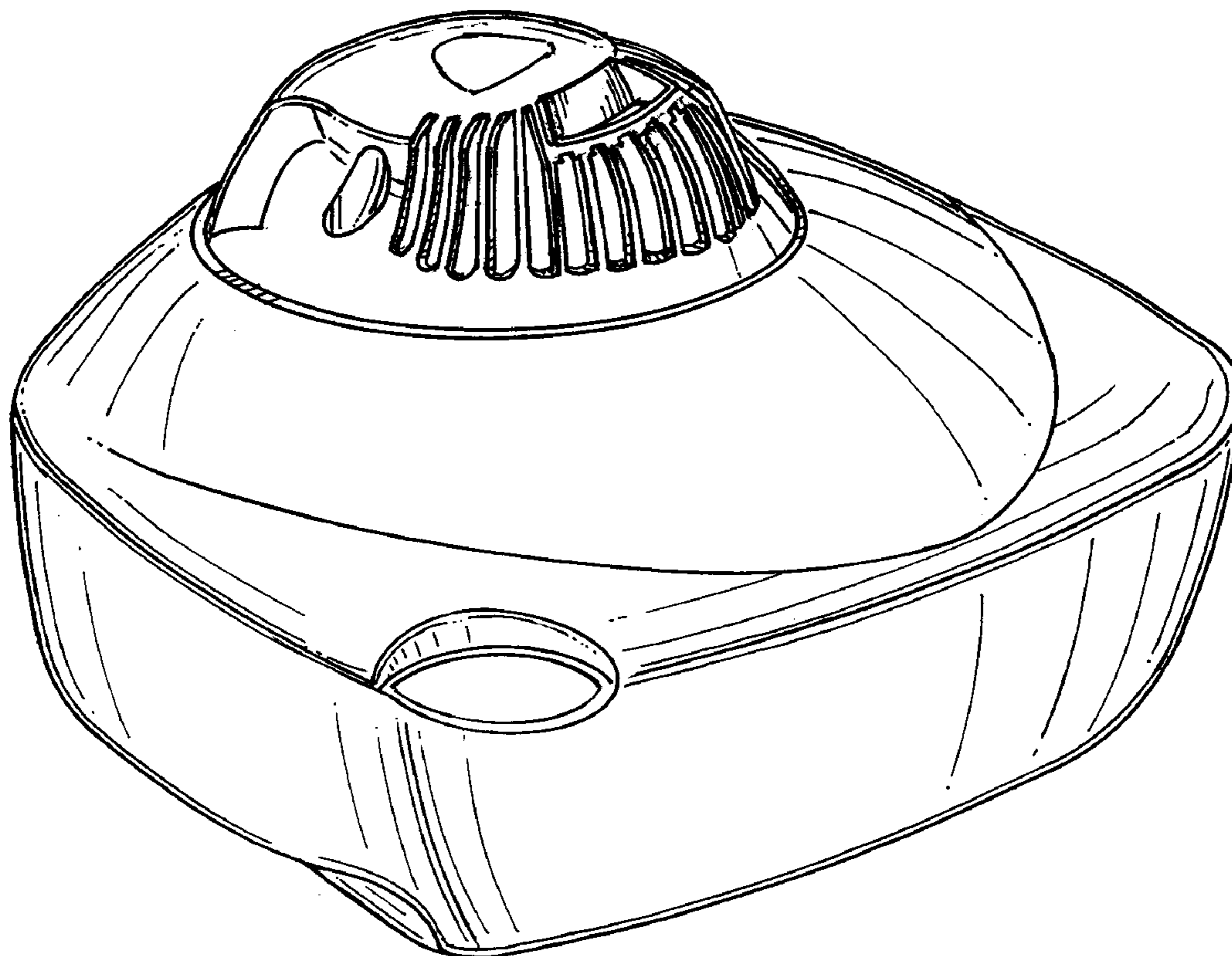

FIG. 1

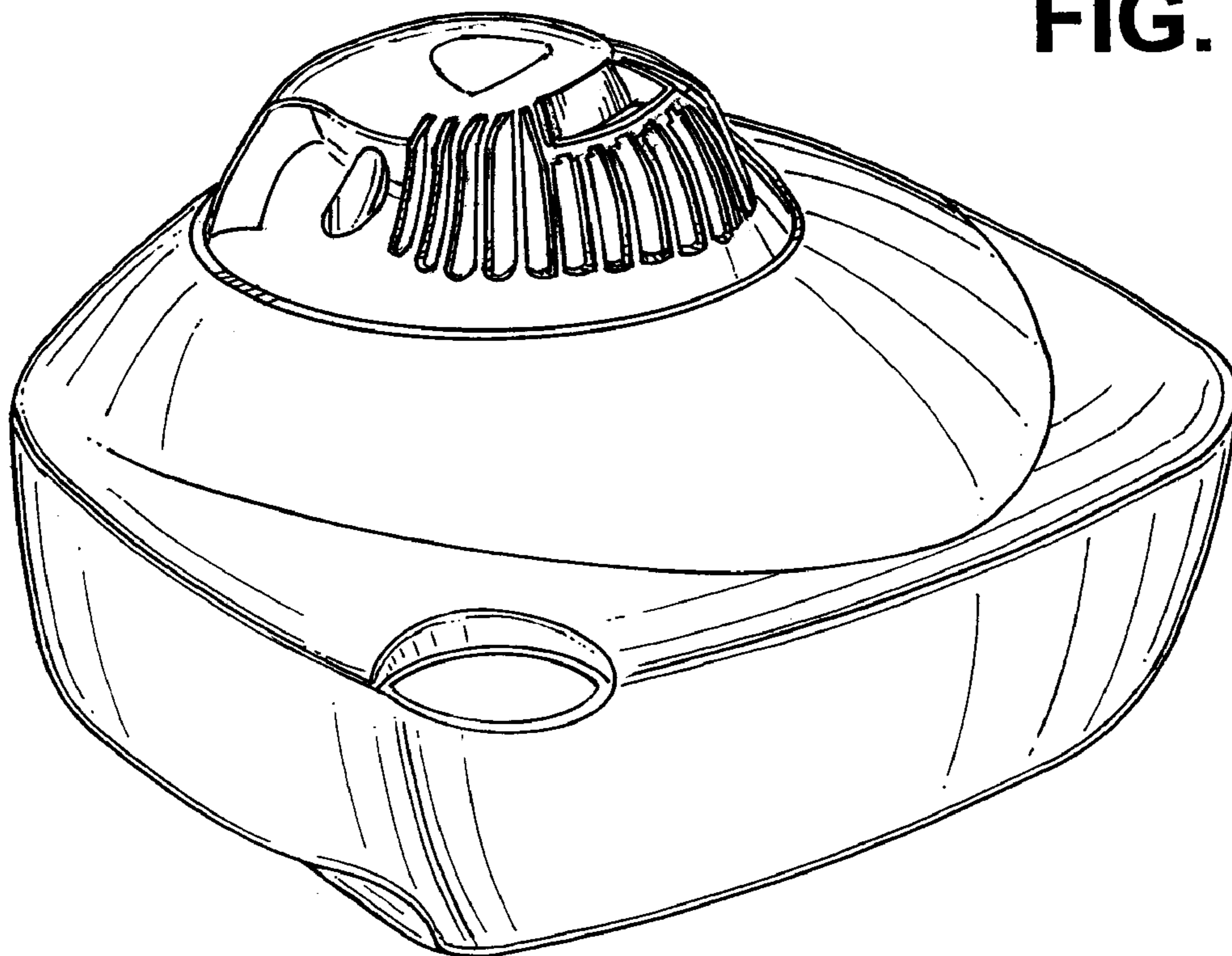

FIG. 2

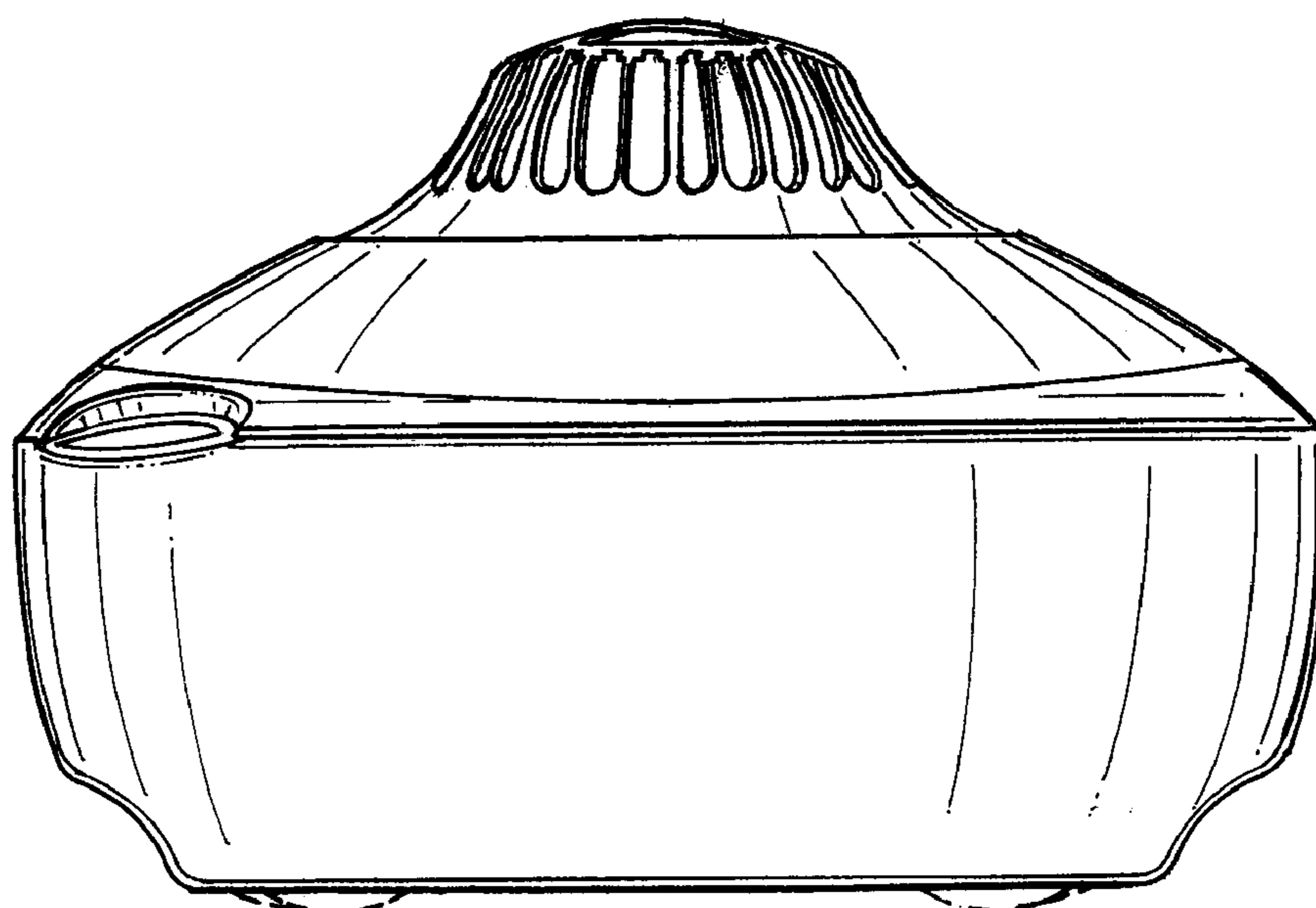

FIG. 3

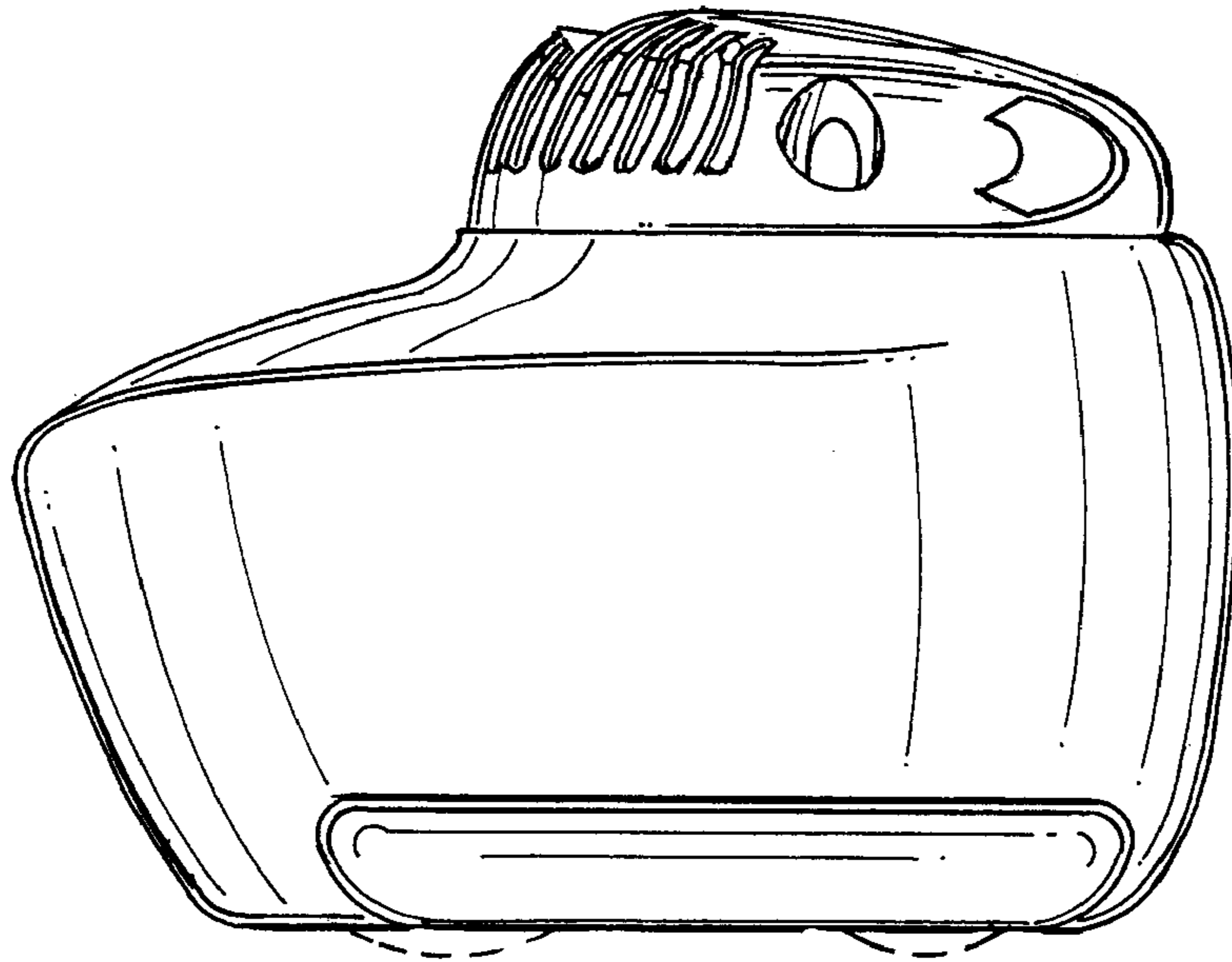

FIG. 4

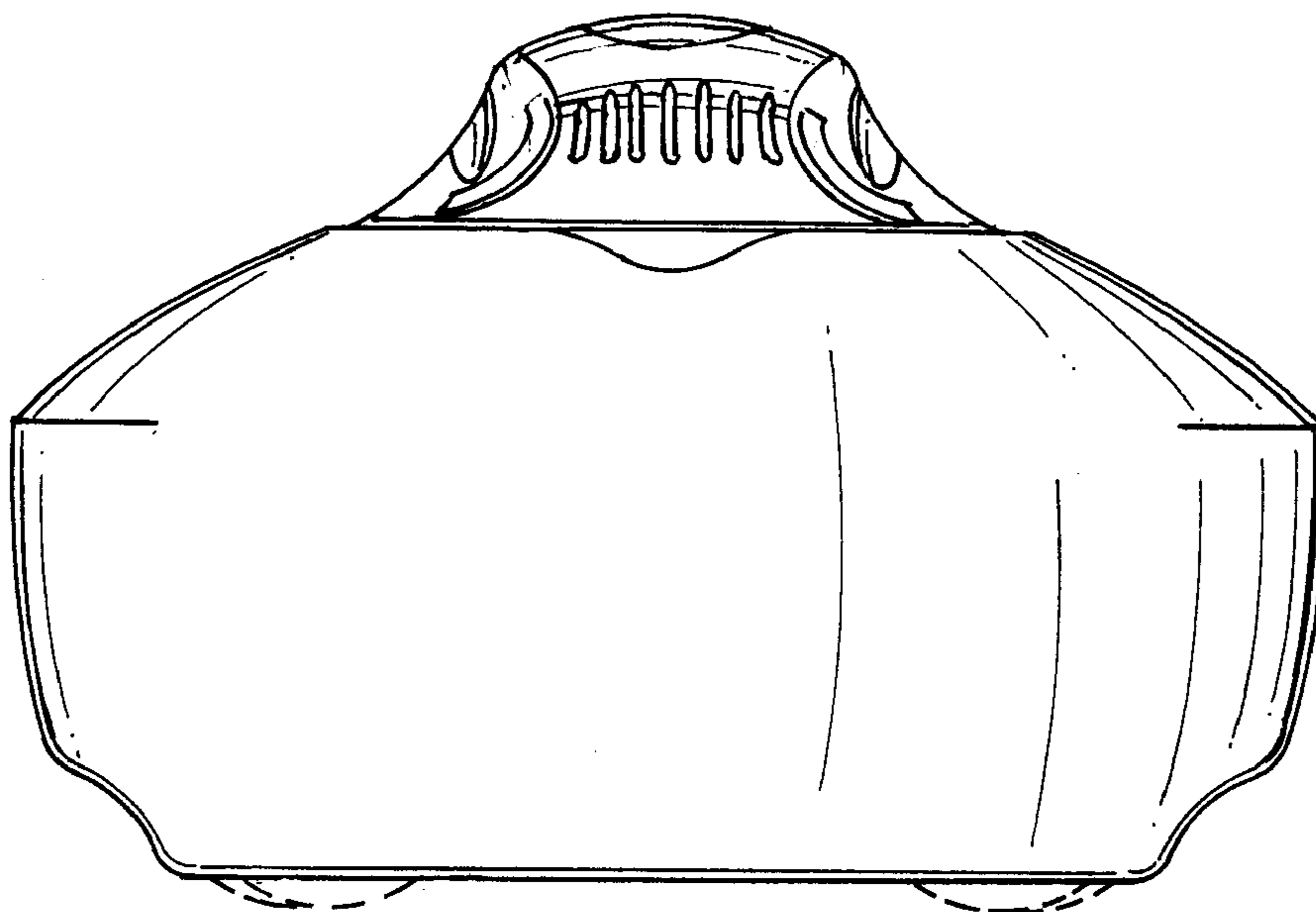

FIG. 5

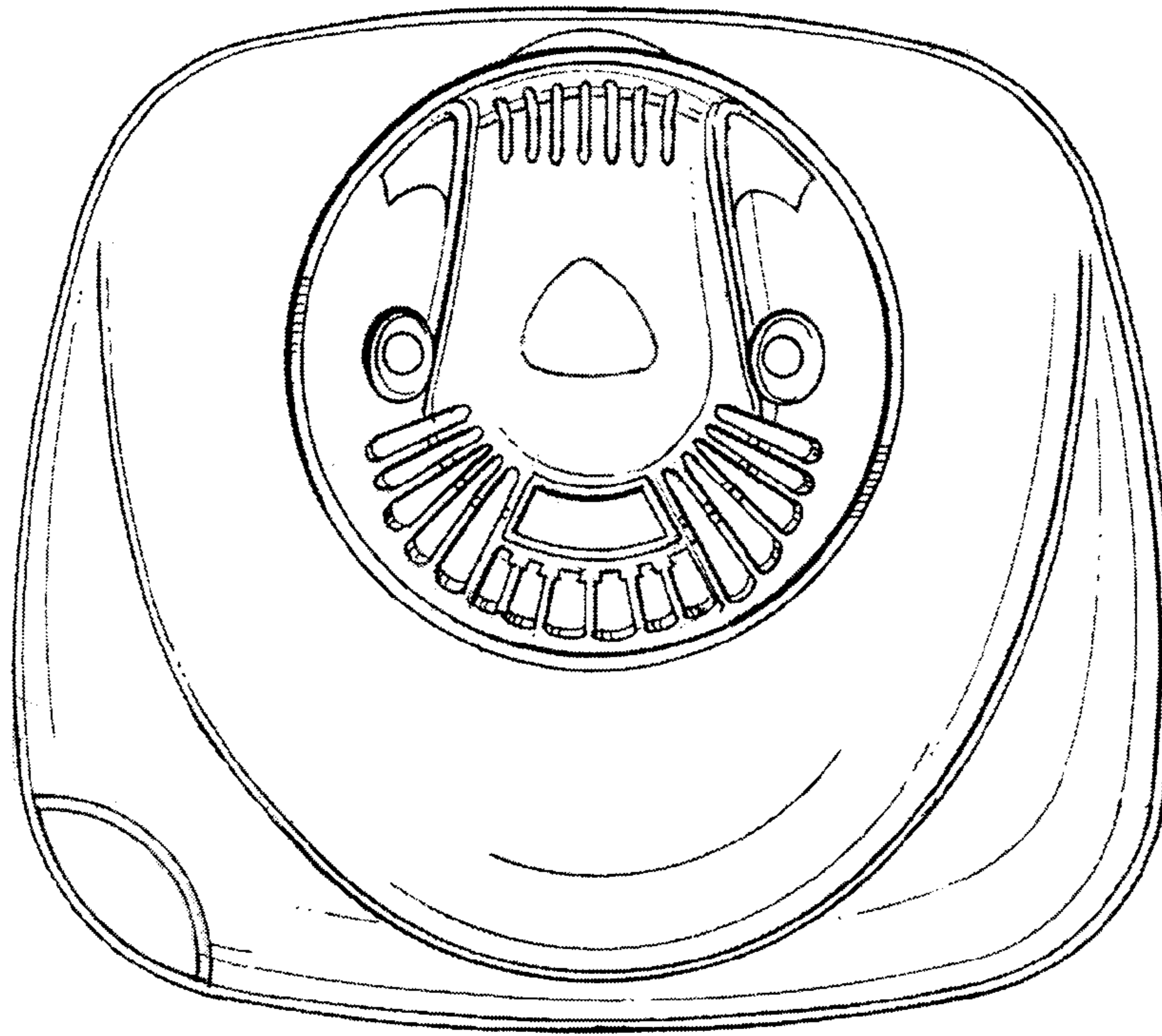
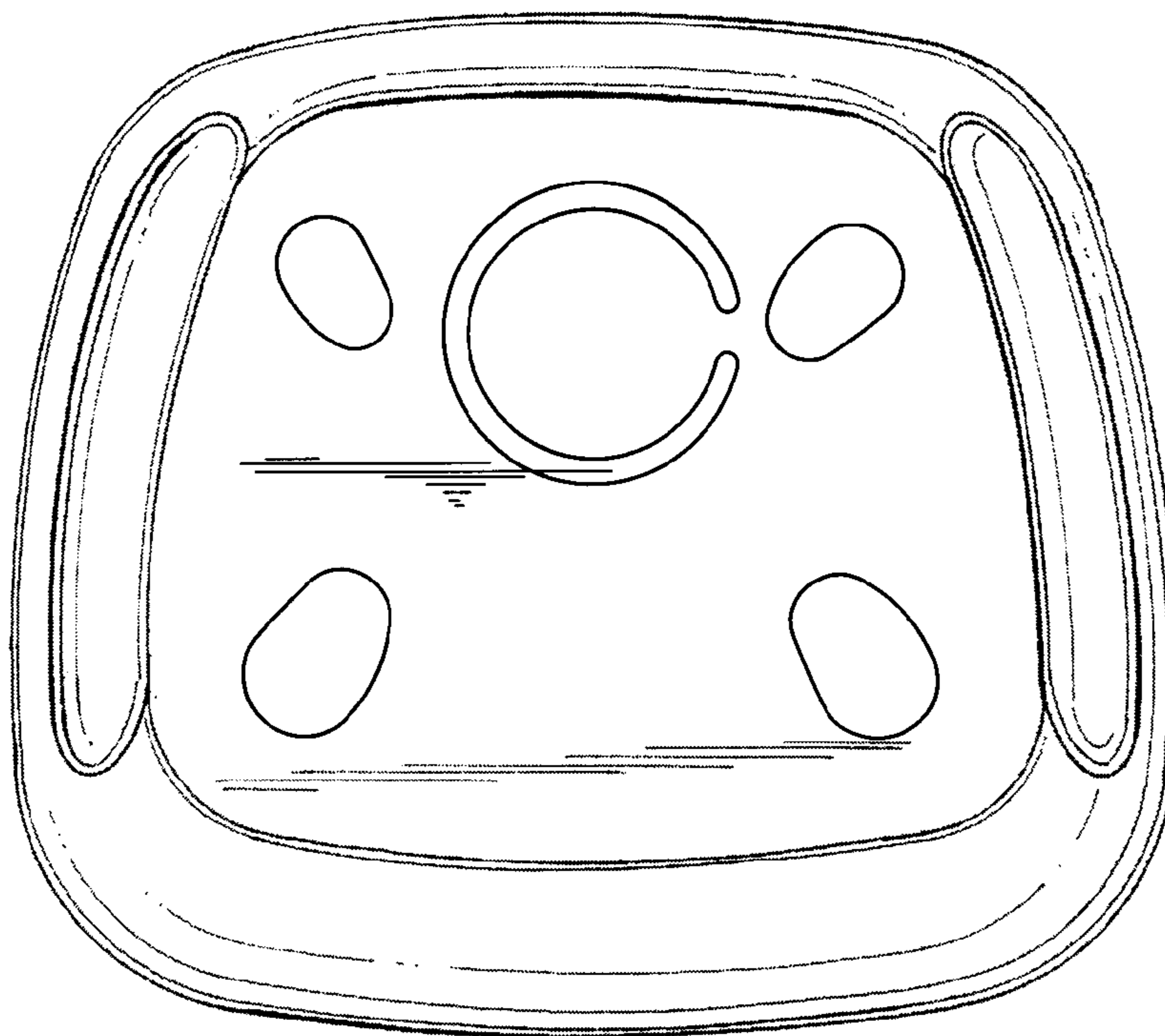

FIG. 6



UNITED STATES PATENT AND TRADEMARK OFFICE
CERTIFICATE OF CORRECTION

PATENT NO. : Des. 529,159 S
APPLICATION NO. : 29/221445
DATED : September 26, 2006
INVENTOR(S) : Stephen Russak et al.

Page 1 of 1

It is certified that error appears in the above-identified patent and that said Letters Patent is hereby corrected as shown below:

Title page Item [75]
In the Inventor's name:

Please delete "Agnete Eng, Brooklyn, NY (US)" and substitute with

-- Agnete Enga, Brooklyn, NY (US) --.

Signed and Sealed this

Twentieth Day of February, 2007

A handwritten signature in black ink on a dotted background. The signature reads "Jon W. Dudas" in a cursive style.

JON W. DUDAS

Director of the United States Patent and Trademark Office