

US00D529136S

(12) **United States Design Patent**
Smith

(10) **Patent No.:** **US D529,136 S**

(45) **Date of Patent:** **** *Sep. 26, 2006**

(54) **TALL BASIN MIXER**

(75) Inventor: **Antony Smith**, Etching Hill (GB)

(73) Assignee: **Bristan, Ltd.** (GB)

(*) Notice: This patent is subject to a terminal disclaimer.

(**) Term: **14 Years**

(21) Appl. No.: **29/239,946**

(22) Filed: **Oct. 6, 2005**

(51) **LOC (8) Cl.** **23-01**

(52) **U.S. Cl.** **D23/238**

(58) **Field of Classification Search** D23/238-257;
4/675-678; 137/801

See application file for complete search history.

(56) **References Cited**

U.S. PATENT DOCUMENTS

D265,229 S * 6/1982 Paul D23/242
D280,232 S * 8/1985 Paul D23/242
D351,218 S * 10/1994 Sieger D23/241

D468,398 S * 1/2003 Ziemann D23/238
D472,961 S * 4/2003 Ziemann D23/238
D509,283 S * 9/2005 Sieger D23/238
D512,483 S * 12/2005 Painsi D23/238

* cited by examiner

Primary Examiner—Louis S. Zarfaz

Assistant Examiner—Gregory Andoll

(74) *Attorney, Agent, or Firm*—Kwadjo Adusei-Poku;
Lloyd D. Doigan

(57) **CLAIM**

The ornamental design for a tall basin mixer, as shown and described.

DESCRIPTION

FIG. 1 is a front perspective view of a tall basin mixer showing my design;

FIG. 2 is a front elevational view thereof;

FIG. 3 is a rear elevational view thereof;

FIG. 4 is a left side elevational view thereof;

FIG. 5 is a right side elevational view thereof; and,

FIG. 6 is a top plan view thereof.

1 Claim, 6 Drawing Sheets

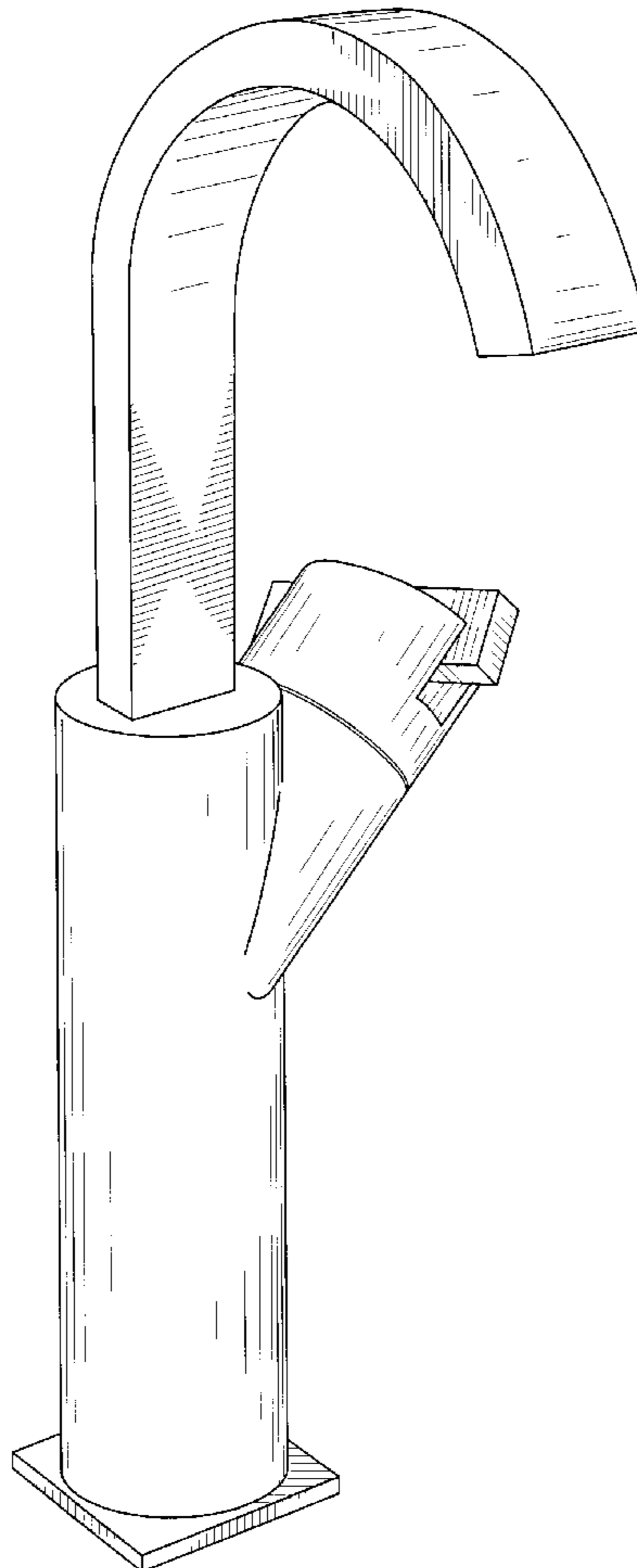

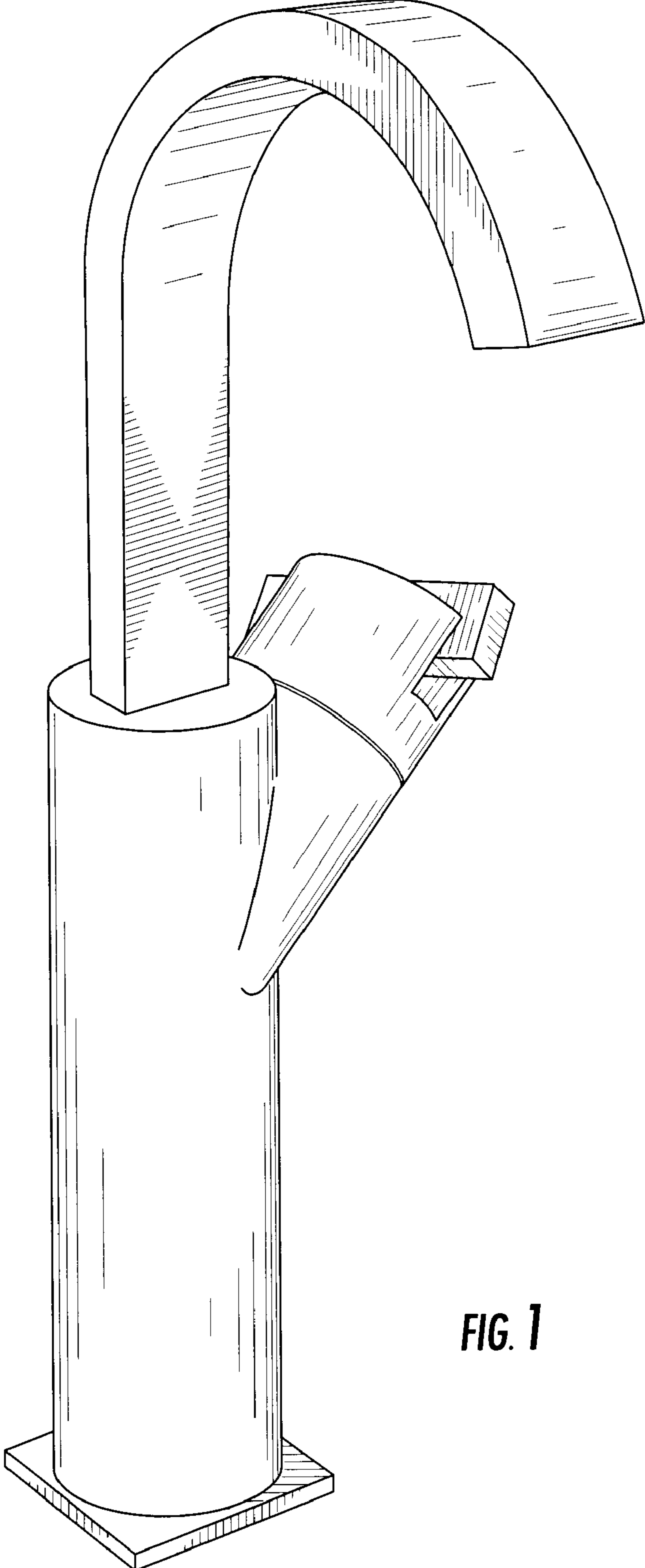

FIG. 1

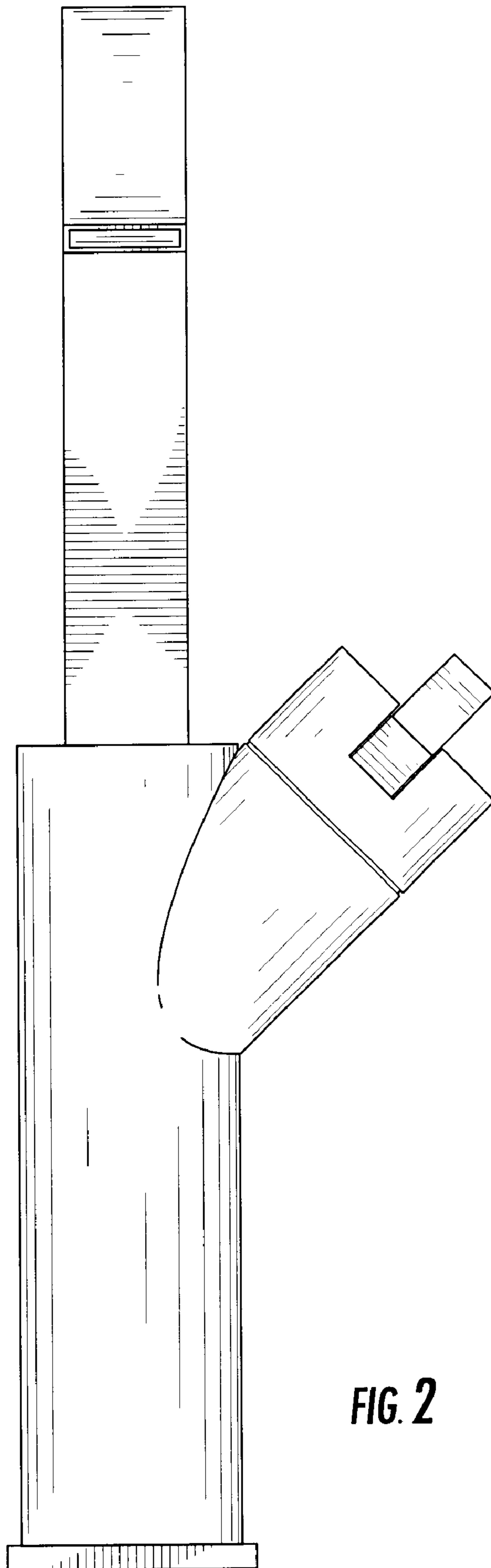

FIG. 2

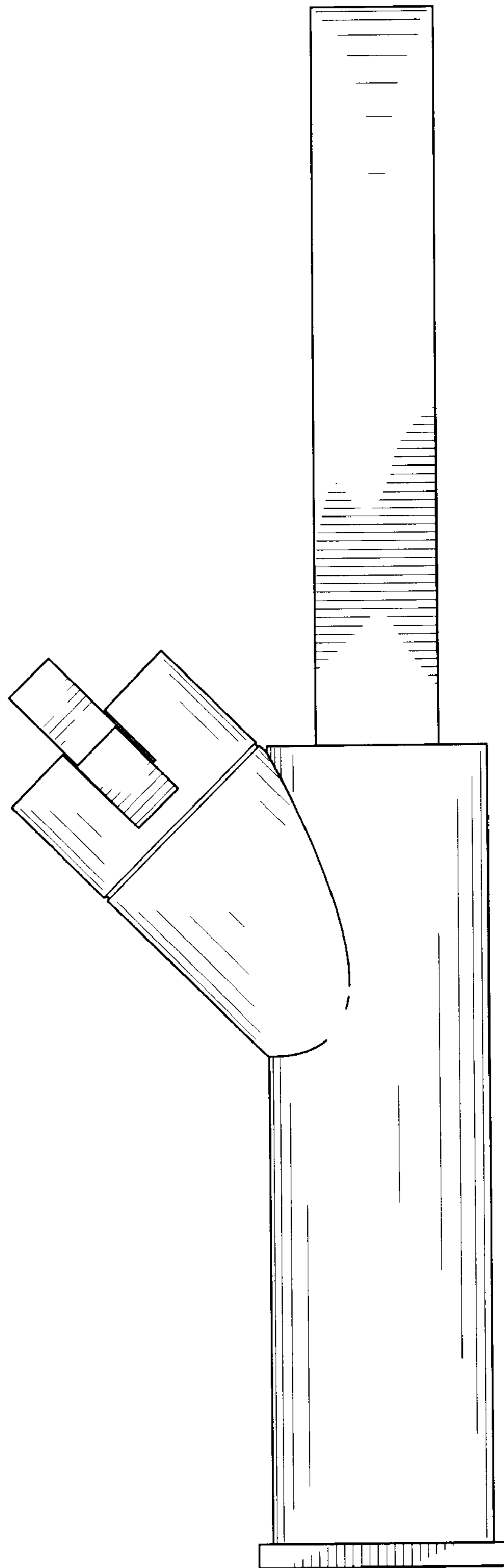

FIG. 3

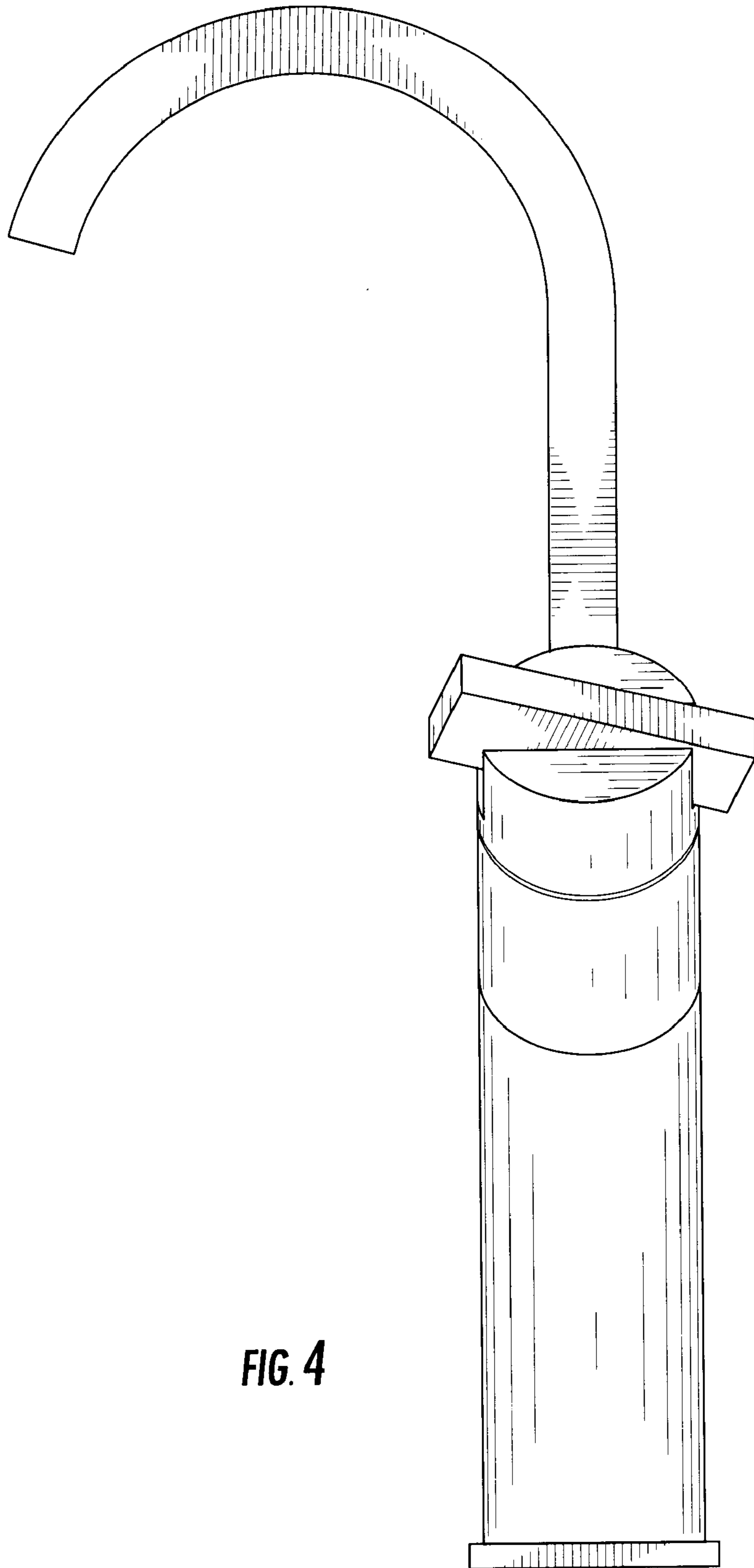

FIG. 4

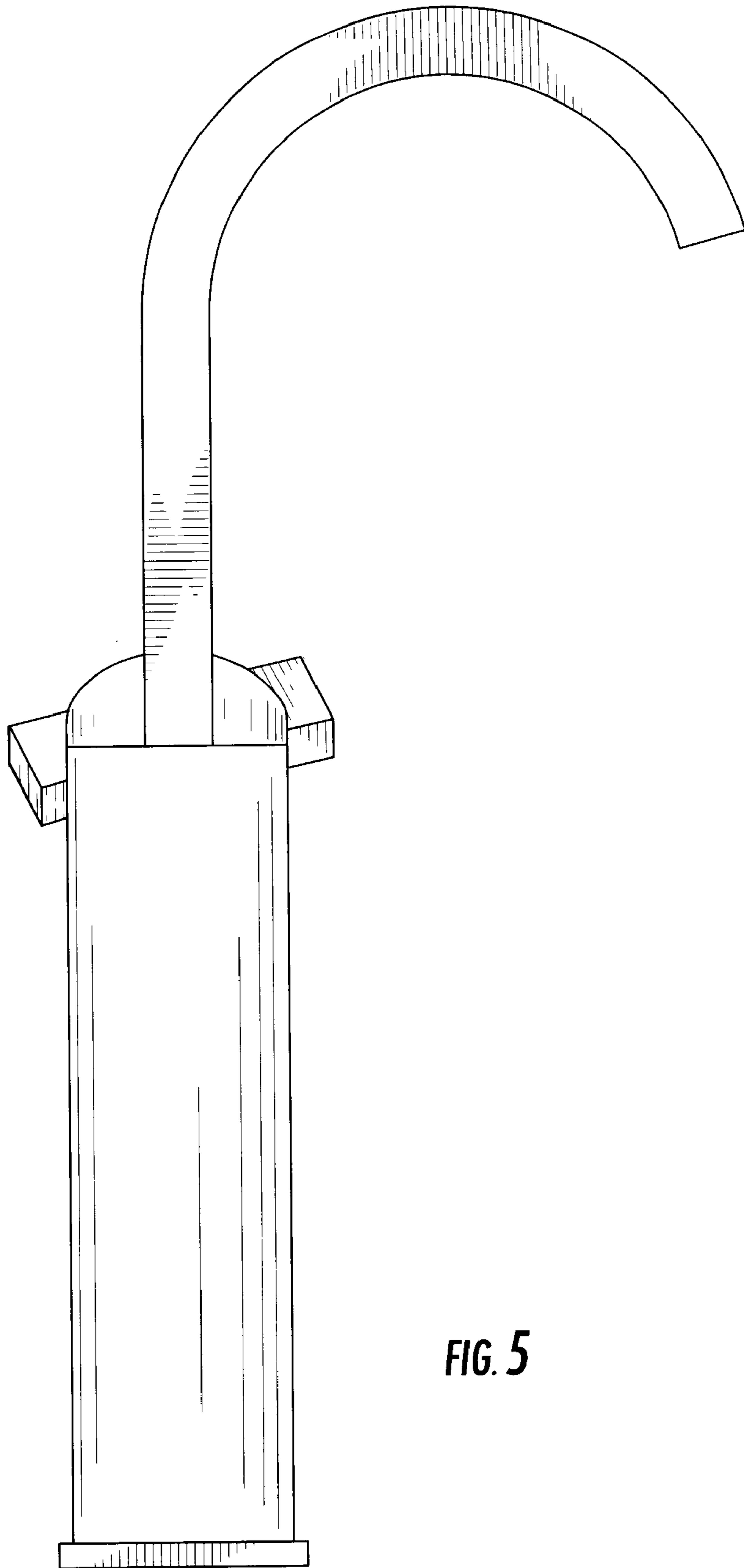

FIG. 5

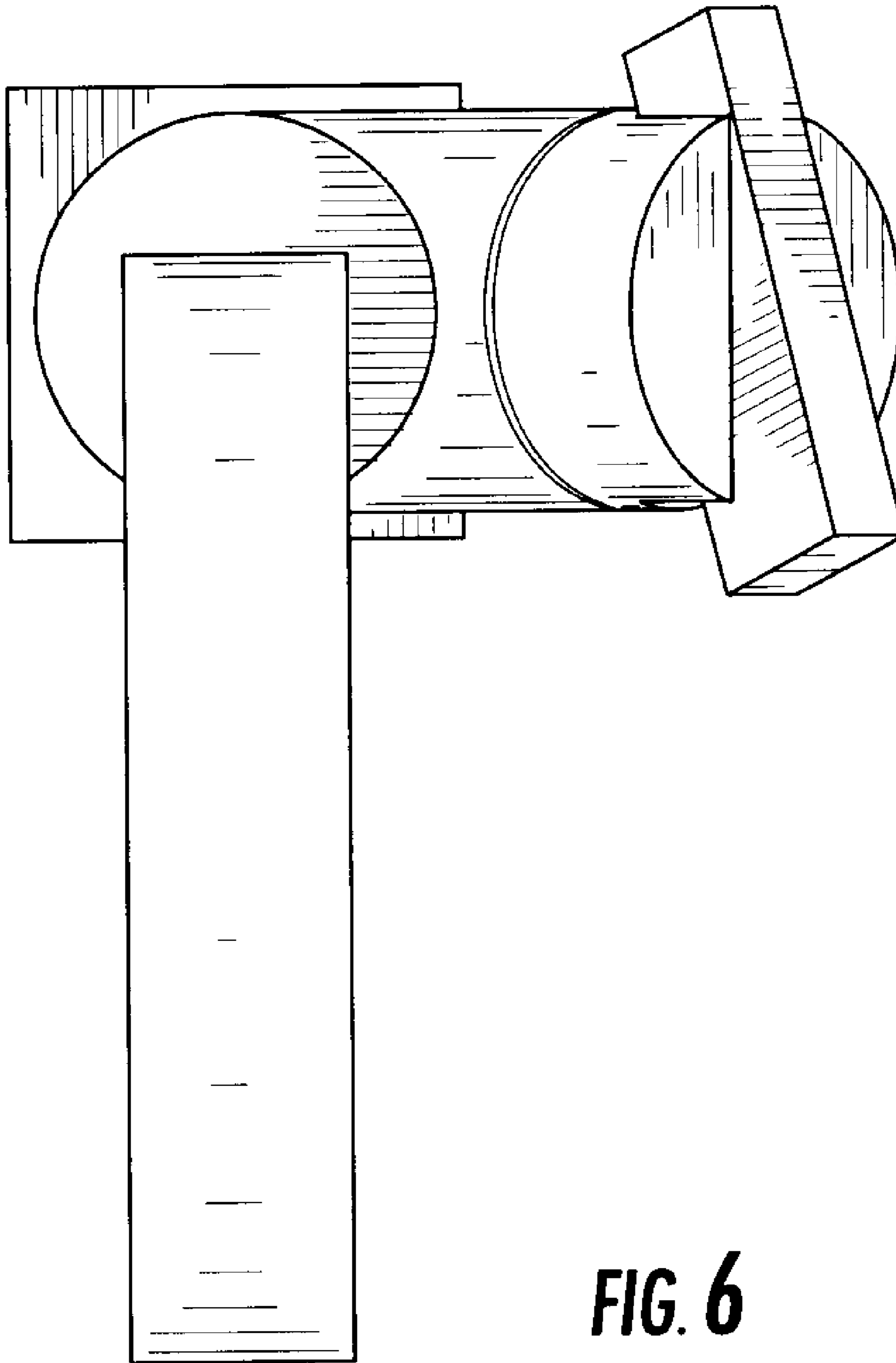

FIG. 6