



US00D529129S

(12) **United States Design Patent**  
**Leer et al.**

(10) **Patent No.: US D529,129 S**

(45) **Date of Patent: \*\* \*Sep. 26, 2006**

(54) **TANK FOR PRESSURIZED SPRAYER**

D513,785 S \* 1/2006 Leer et al. .... D23/225

D516,167 S \* 2/2006 Leer et al. .... D23/225

D516,168 S \* 2/2006 Leer et al. .... D23/225

(75) Inventors: **Rick L. Leer**, Somerset, PA (US);  
**Douglas Burnworth**, Confluence, PA  
(US)

\* cited by examiner

*Primary Examiner*—Robin Webster

(73) Assignee: **Gilmour, Inc.**, Newark, DE (US)

(74) *Attorney, Agent, or Firm*—Victor A. Henzi

(\* ) Notice: This patent is subject to a terminal disclaimer.

(57) **CLAIM**

(\*\* ) Term: **14 Years**

The ornamental design for a tank for pressurized sprayer, as shown and described.

(21) Appl. No.: **29/228,851**

**DESCRIPTION**

(22) Filed: **Apr. 30, 2005**

FIG. 1 is a front elevational view of the present new design for a tank for pressurized sprayer configured to include an exemplary hand pump assembly which is illustrated in dashed lines and forms no part of the claimed design;

(51) **LOC (8) Cl.** ..... **23-01**

(52) **U.S. Cl.** ..... **D23/225**

(58) **Field of Classification Search** ..... D23/213,  
D23/225; 222/394, 400.8; 239/302, 308,  
239/337, 373

FIG. 2 is a front right perspective view thereof;  
FIG. 3 is a front elevational view thereof;  
FIG. 4 is a left elevational view thereof;  
FIG. 5 is a rear elevational view thereof;  
FIG. 6 is a right elevational view thereof;  
FIG. 7 is a top plan view thereof; and,  
FIG. 8 is a bottom plan view thereof.

See application file for complete search history.

The broken lines showing various features of a tank for pressurized sprayer are for illustrative purposes only and form no part of the claimed design.

(56) **References Cited**

**U.S. PATENT DOCUMENTS**

D295,886 S \* 5/1988 Dolton et al. .... D23/205

D431,279 S \* 9/2000 Spriegel ..... D23/225

6,695,228 B1 \* 2/2004 Odessa ..... 239/337

**1 Claim, 7 Drawing Sheets**

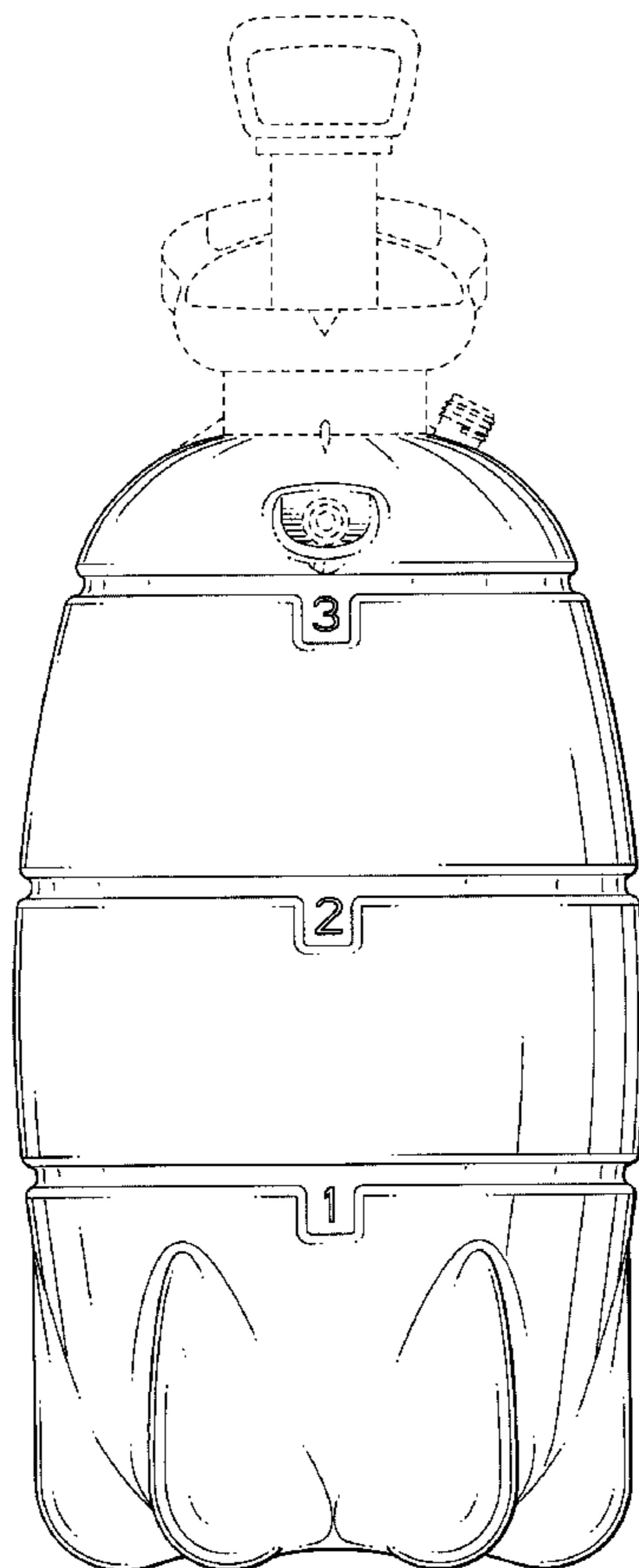

FIG. 1

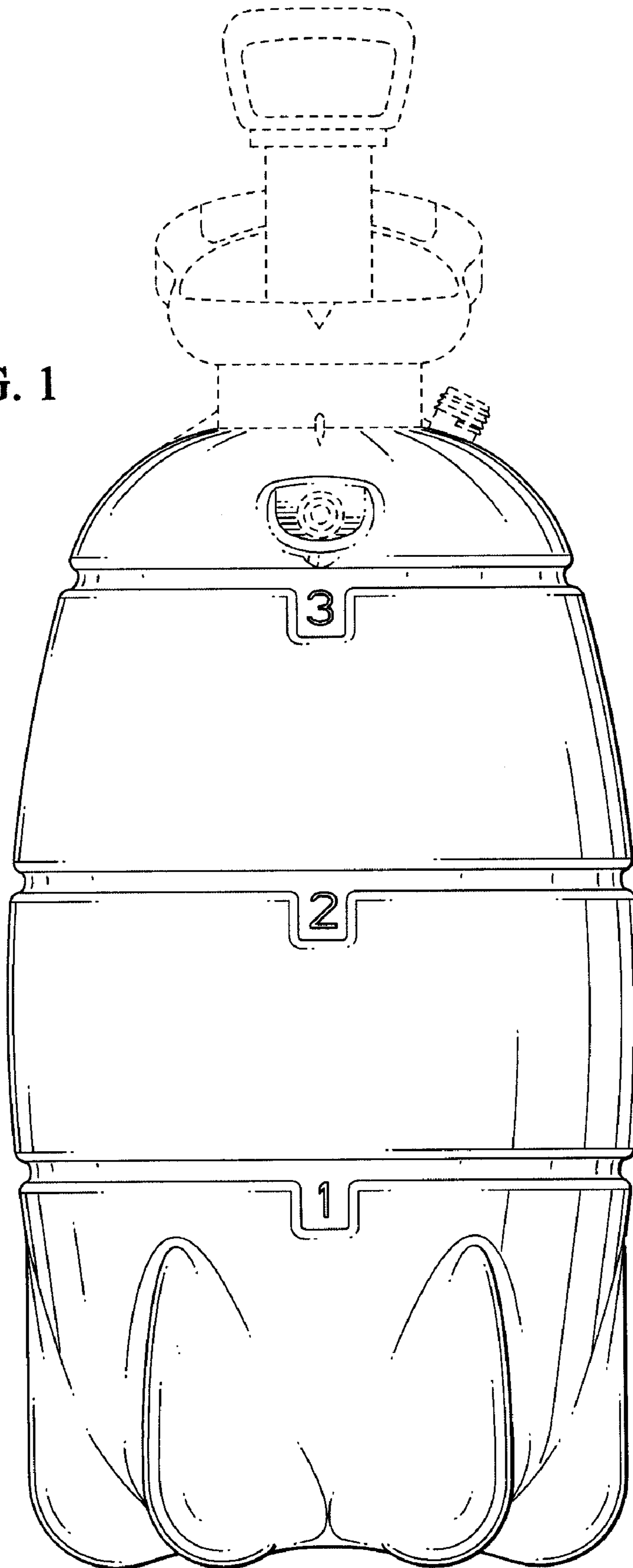

FIG. 2

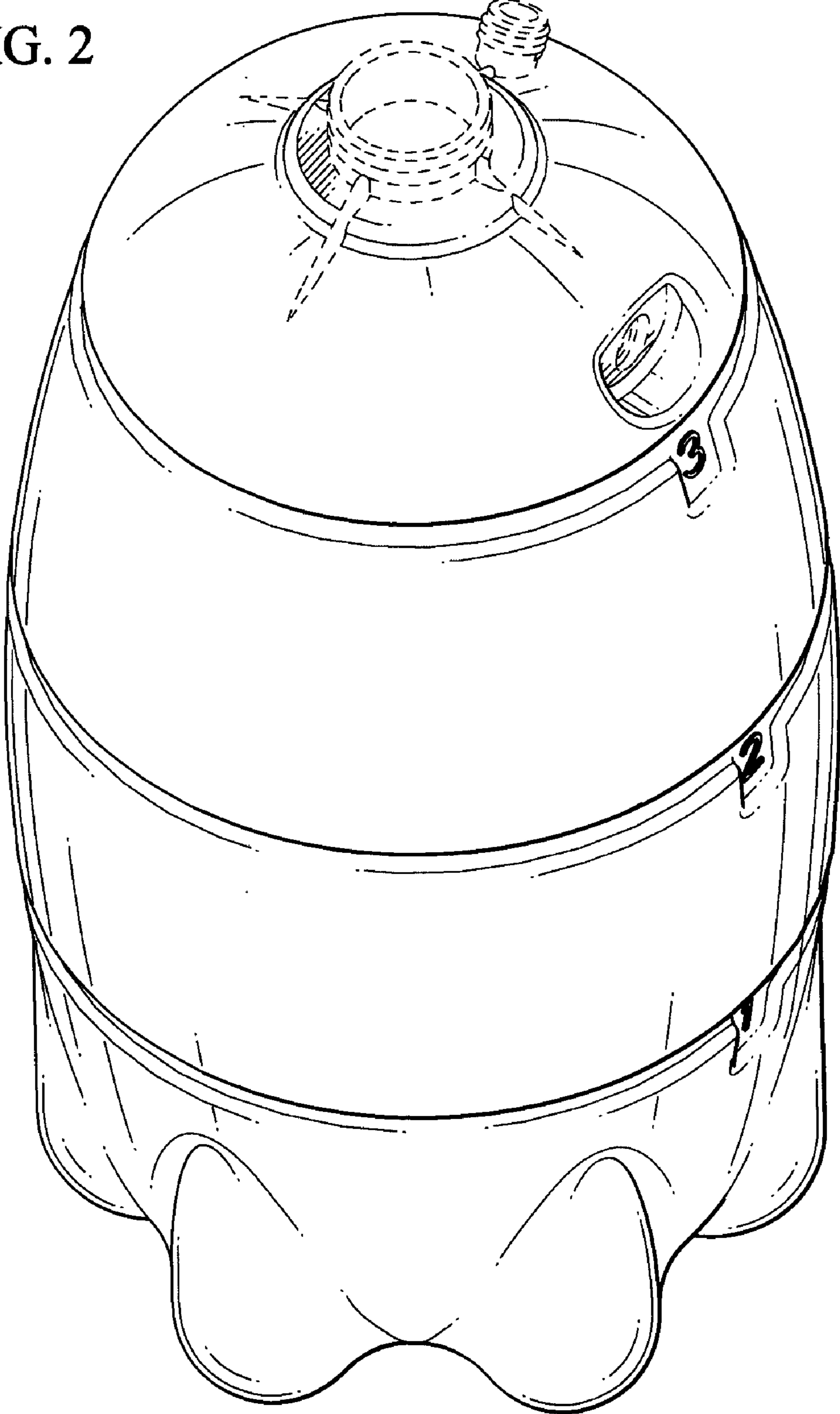

FIG. 3

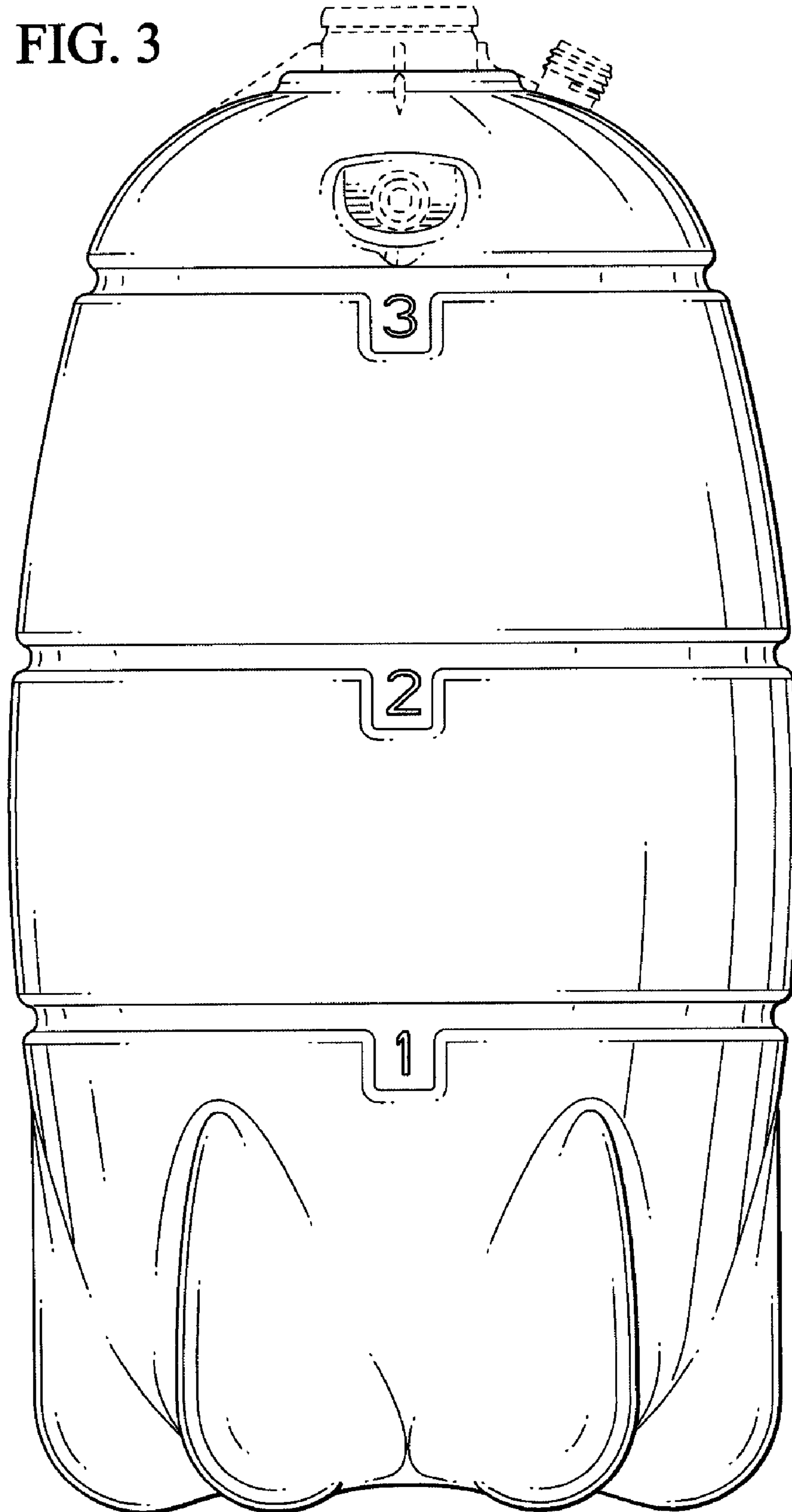

FIG. 4

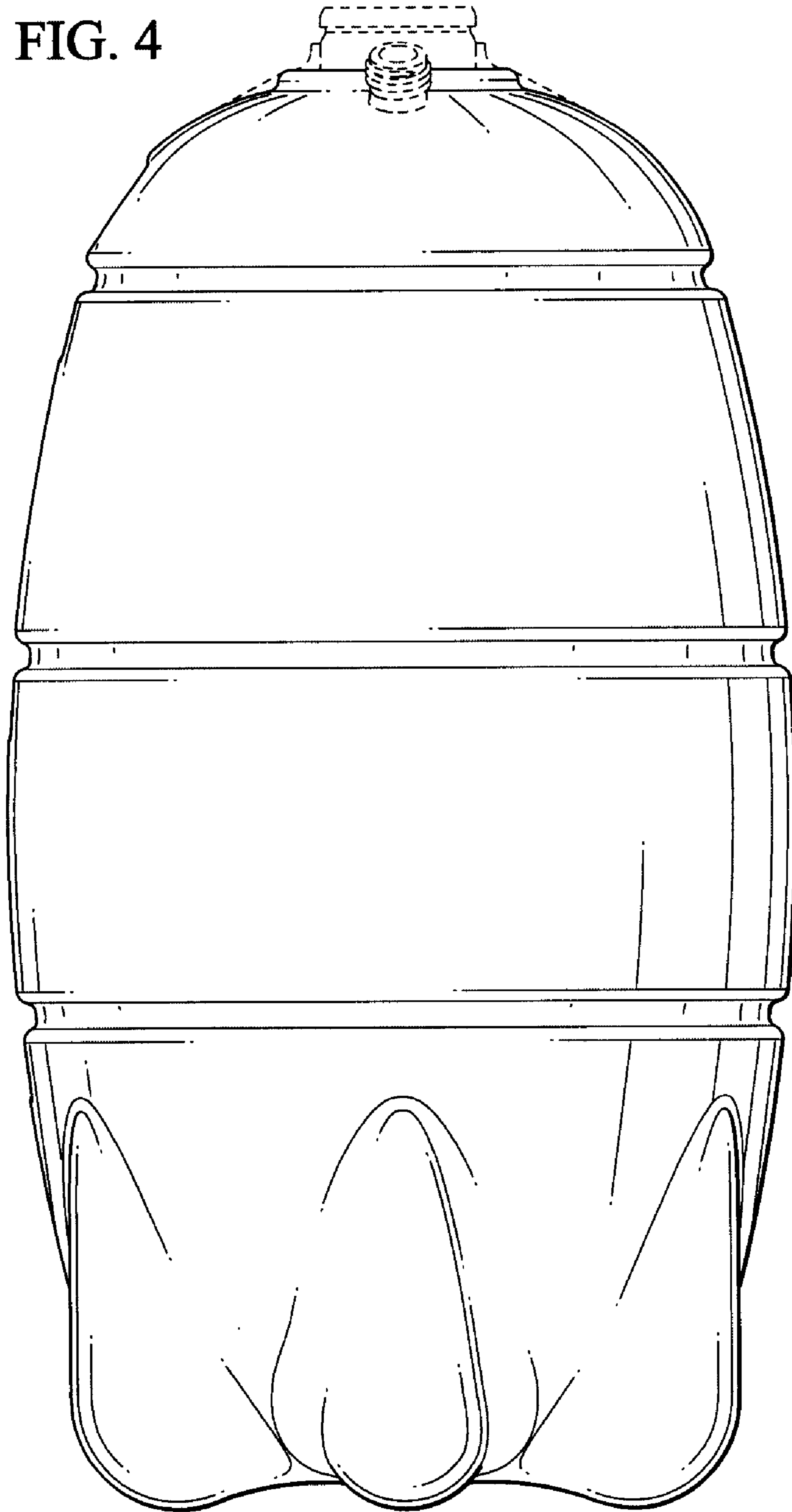

FIG. 5

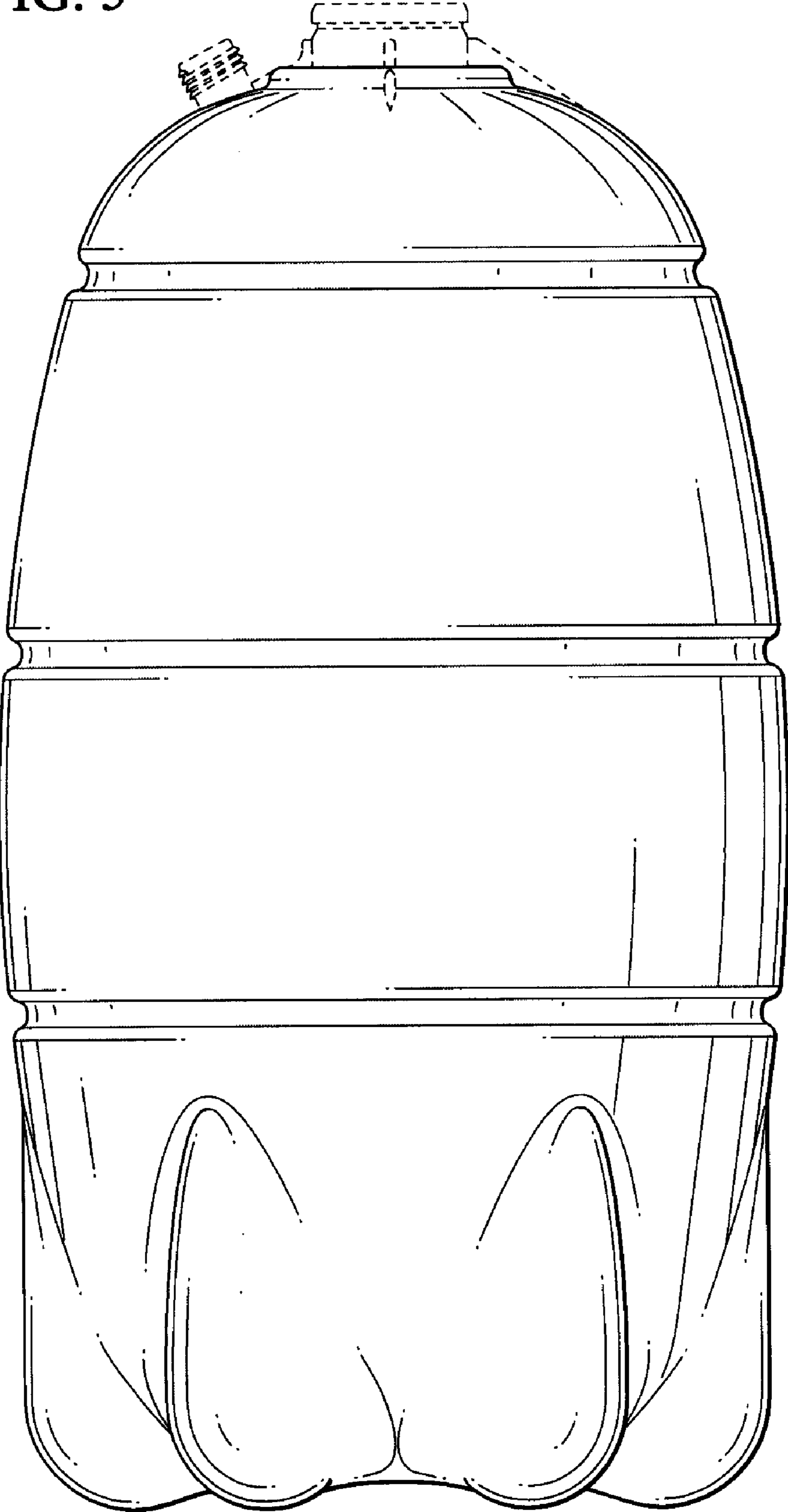
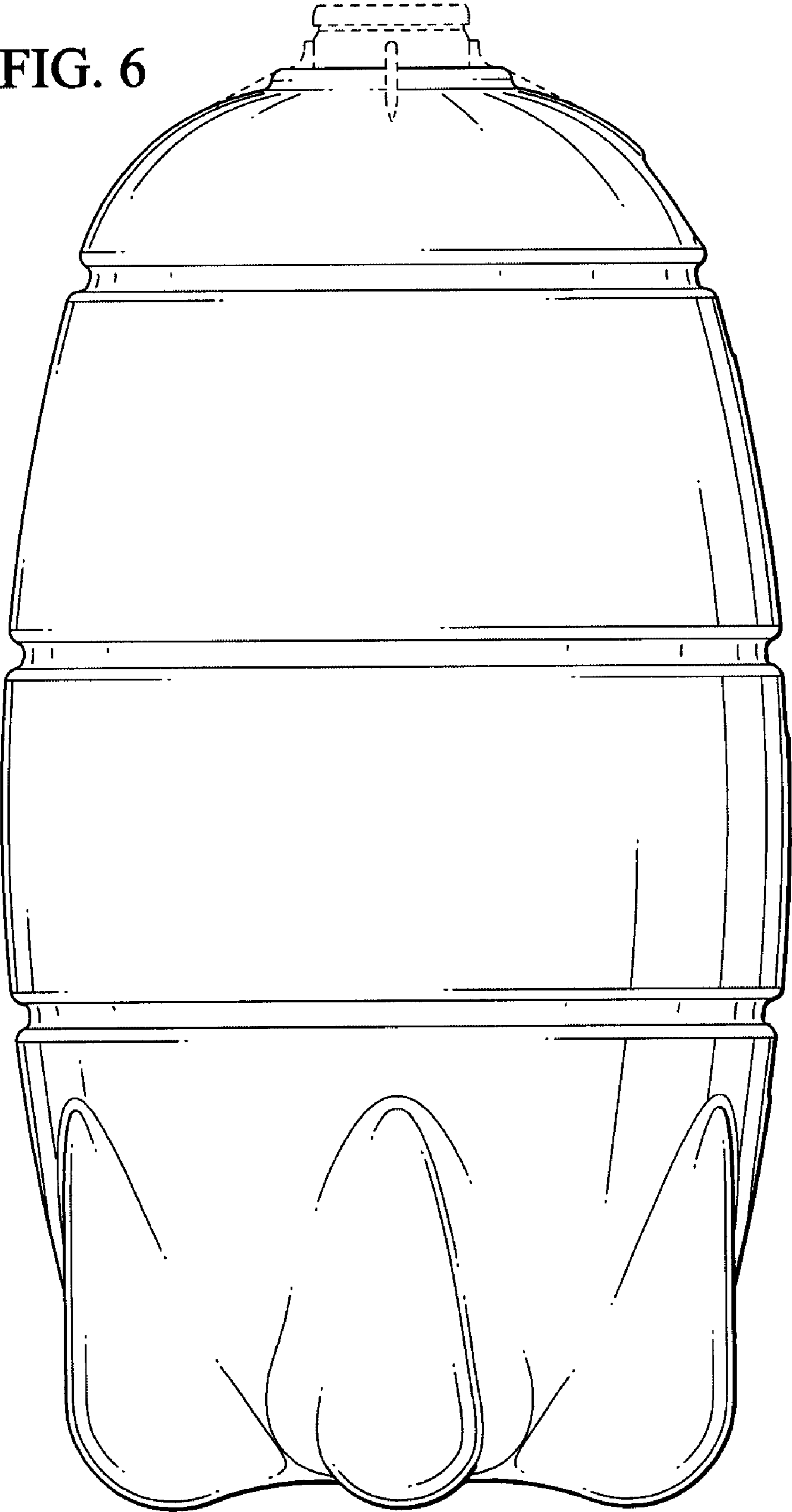

FIG. 6



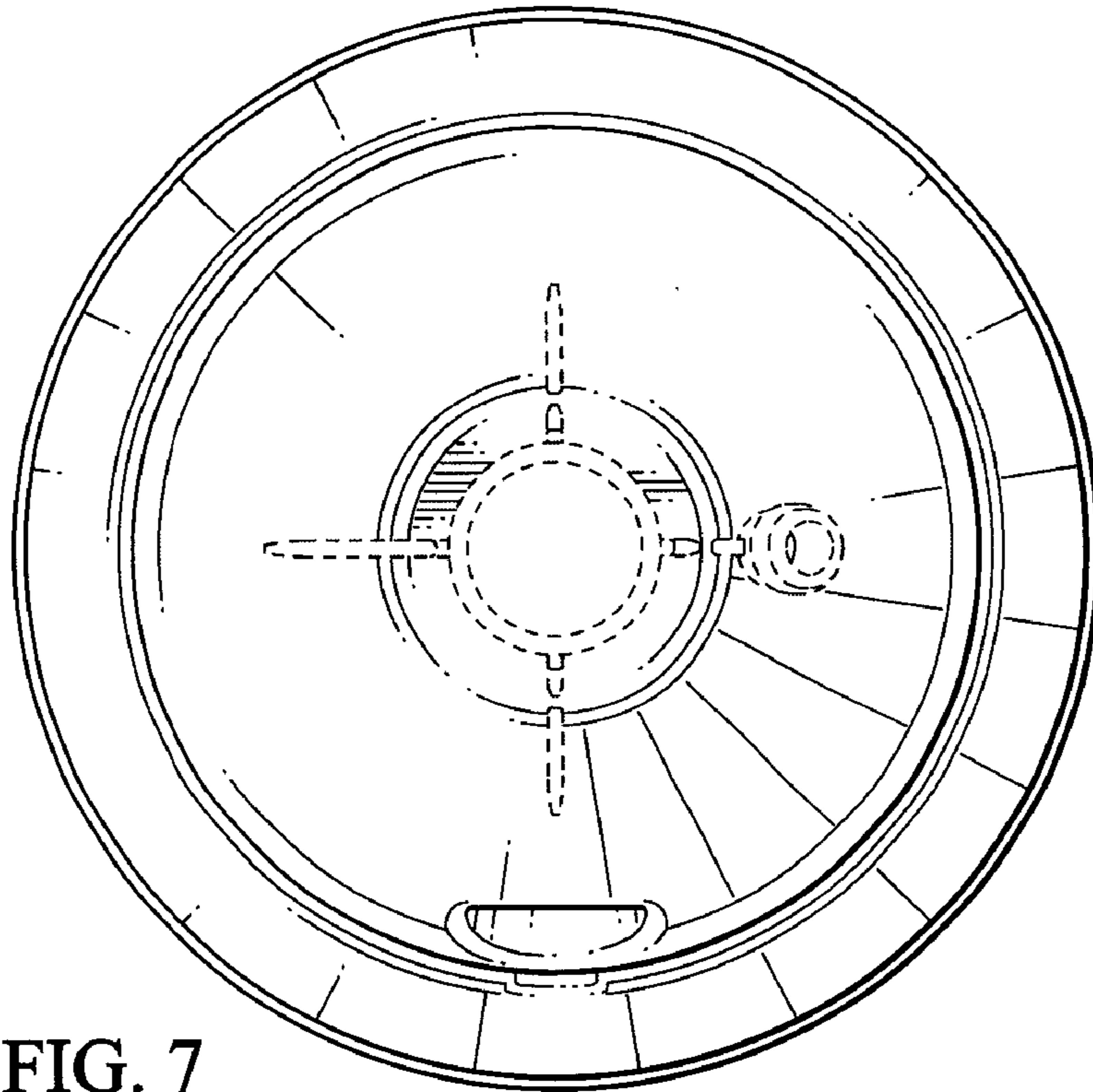

FIG. 7

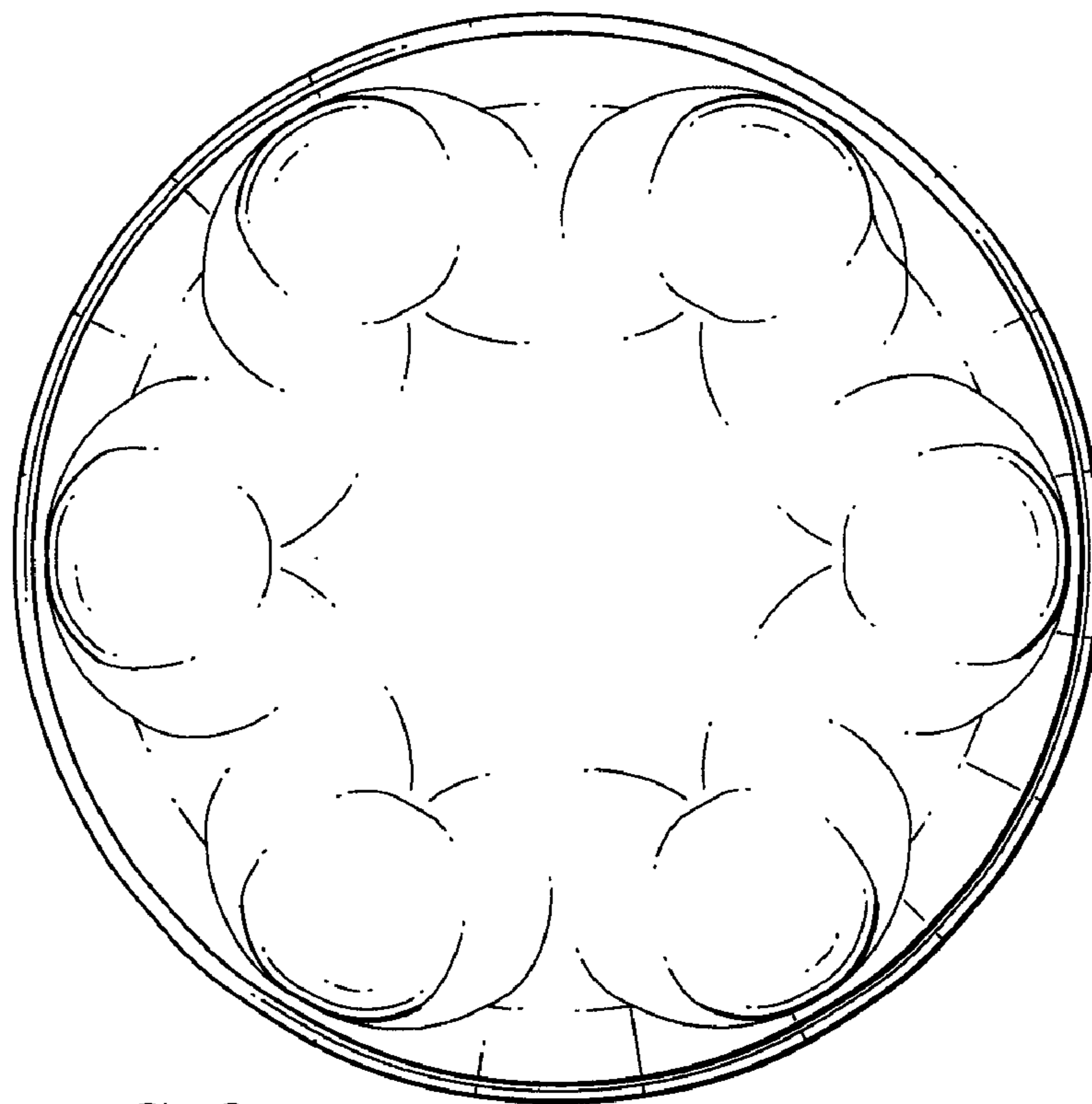

FIG. 8