

US00D529086S

(12) **United States Design Patent**
Wehmeyer

(10) **Patent No.:** **US D529,086 S**

(45) **Date of Patent:** **** Sep. 26, 2006**

- (54) **BOOK COVER**
- (75) Inventor: **Stephen D. Wehmeyer**, Cincinnati, OH (US)
- (73) Assignee: **MeadWestvaco Corporation**, Stamford, CT (US)
- (**) Term: **14 Years**
- (21) Appl. No.: **29/226,207**
- (22) Filed: **Mar. 25, 2005**

Related U.S. Application Data

- (63) Continuation-in-part of application No. 10/962,724, filed on Oct. 12, 2004, which is a continuation-in-part of application No. 10/828,073, filed on Apr. 20, 2004.
- (51) **LOC (8) Cl.** **19-04**
- (52) **U.S. Cl.** **D19/26**
- (58) **Field of Classification Search** D19/26-33; 281/15.1, 19.1, 21.1, 22, 28, 29, 38, 50, 51, 281/27.1, 27.2, 27.3; 283/63.1, 64; 402/73, 402/74, 75
See application file for complete search history.

(56) **References Cited**

U.S. PATENT DOCUMENTS

2,529,288	A	*	11/1950	Gibson	206/215
3,025,834	A		3/1962	Aaron		
3,077,184	A		2/1963	Vogel		
D220,296	S		3/1971	Berlin		
3,684,389	A		8/1972	Eron et al.		
3,941,488	A		3/1976	Maxwell		
3,985,455	A		10/1976	Wahlberg		
4,221,490	A		9/1980	Malm		
4,357,431	A		11/1982	Murakami et al.		
4,509,875	A		4/1985	Shintani		
D279,992	S		8/1985	Gribb		
4,549,827	A		10/1985	Mack		
4,557,618	A		12/1985	Iwata et al.		
4,600,327	A		7/1986	Guzman		
D295,878	S		5/1988	Lovell		
D303,683	S		9/1989	Brock		

D306,316	S		2/1990	Shintani		
D306,873	S		3/1990	Yazaki		
D307,602	S		5/1990	Lee		
5,033,895	A		7/1991	Aida		
5,072,483	A		12/1991	Durand		
5,131,776	A		7/1992	Mott		
D336,425	S		6/1993	Napora, Jr.		
5,338,123	A		8/1994	Obersteller et al.		
5,432,973	A		7/1995	Wagner et al.		
5,489,331	A		2/1996	Miller et al.		
5,492,558	A		2/1996	Miller et al.		
5,501,326	A	*	3/1996	Shuhsiung	206/307.1
5,660,514	A	*	8/1997	Wilson	412/1
D404,069	S		1/1999	Hasegawa		
5,855,442	A		1/1999	Keller		
5,895,160	A		4/1999	Ginelli		
5,957,700	A		9/1999	Ariyama		
6,004,057	A		12/1999	Fulop		
6,019,535	A		2/2000	Turner		
6,031,023	A		2/2000	Carroll et al.		
6,048,121	A		4/2000	Carver		

(Continued)

Primary Examiner—Elizabeth A. Albert
(74) *Attorney, Agent, or Firm*—Thompson Hine LLP

(57) **CLAIM**

The ornamental design for a book cover, as shown and described.

DESCRIPTION

FIG. 1 is a front perspective view of a book cover showing my new design;
FIG. 2 is a rear perspective view of the book cover of FIG. 1;
FIG. 3 is a front view of the book cover of FIG. 1;
FIG. 4 is a rear view of the book cover of FIG. 1;
FIG. 5 is a first end view of the book cover of FIG. 1;
FIG. 6 is a second end view of the book cover of FIG. 1;
FIG. 7 is a first side view of the book cover of FIG. 1; and,
FIG. 8 is a second side view of the book cover of FIG. 1.
The broken lines are for illustrative purposes only and do not constitute any part of the claimed design.

1 Claim, 6 Drawing Sheets

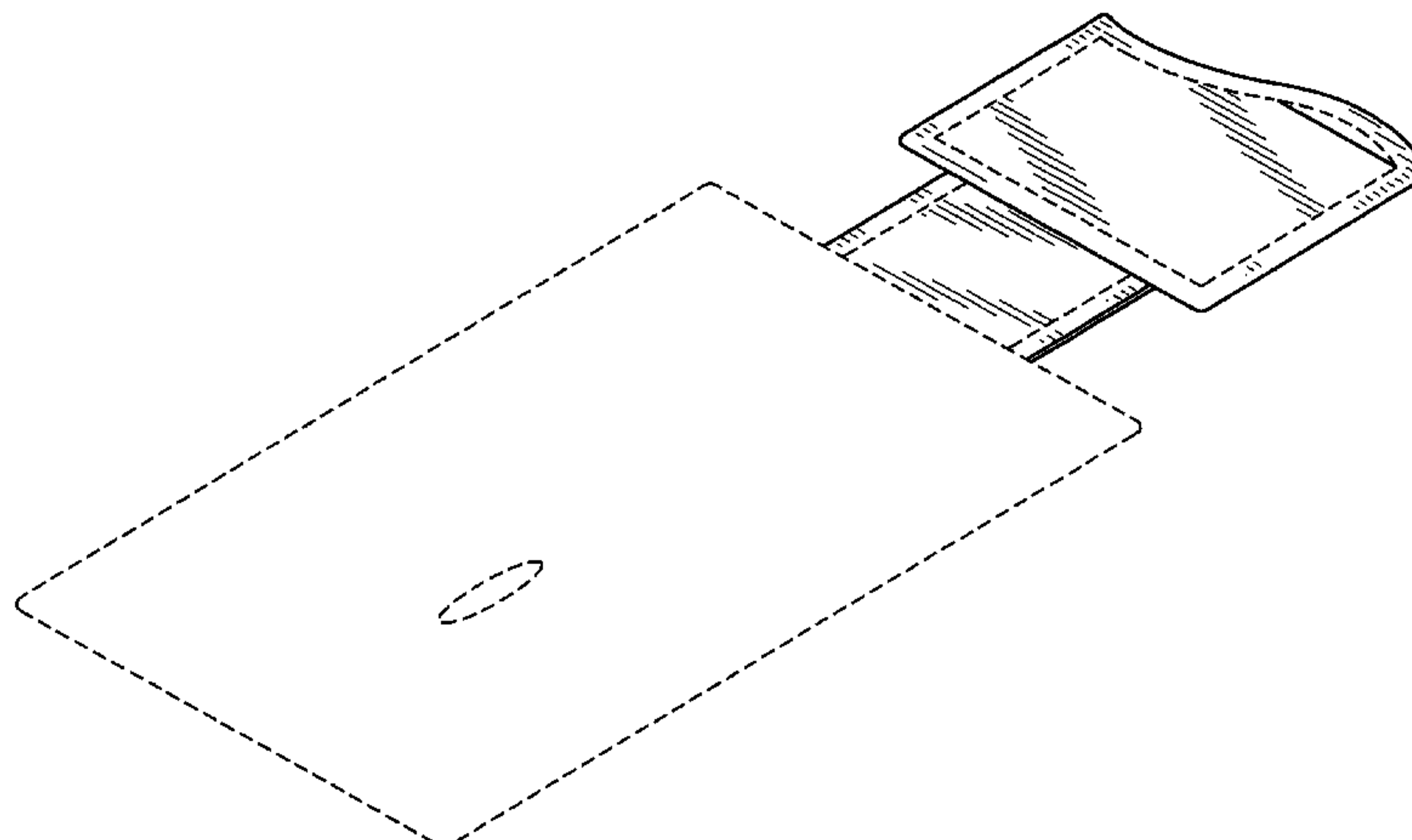

US D529,086 S

Page 2

U.S. PATENT DOCUMENTS

6,179,501 B1	1/2001	Fulop	D471,586 S	3/2003	Geiselhart et al.	
6,250,006 B1	6/2001	Berrier	6,565,275 B1	5/2003	Brand et al.	
D445,130 S	7/2001	Ginelli	6,607,216 B1	8/2003	Stenger et al.	
D451,139 S	11/2001	Wang	6,769,829 B1	8/2004	Castillo et al.	
6,344,498 B1	2/2002	Allison et al.	D509,541 S *	9/2005	Kim	D19/99
6,379,001 B1	4/2002	Tomida et al.	2003/0155761 A1	8/2003	Stenger et al.	
6,435,747 B1	8/2002	Furukawa et al.	2003/0157472 A1	8/2003	Castillo et al.	
6,491,464 B1	12/2002	Young	2004/0247374 A1 *	12/2004	Smith et al.	402/73
6,505,984 B1	1/2003	Smith et al.	2005/0238415 A1 *	10/2005	Busam et al.	402/73

* cited by examiner

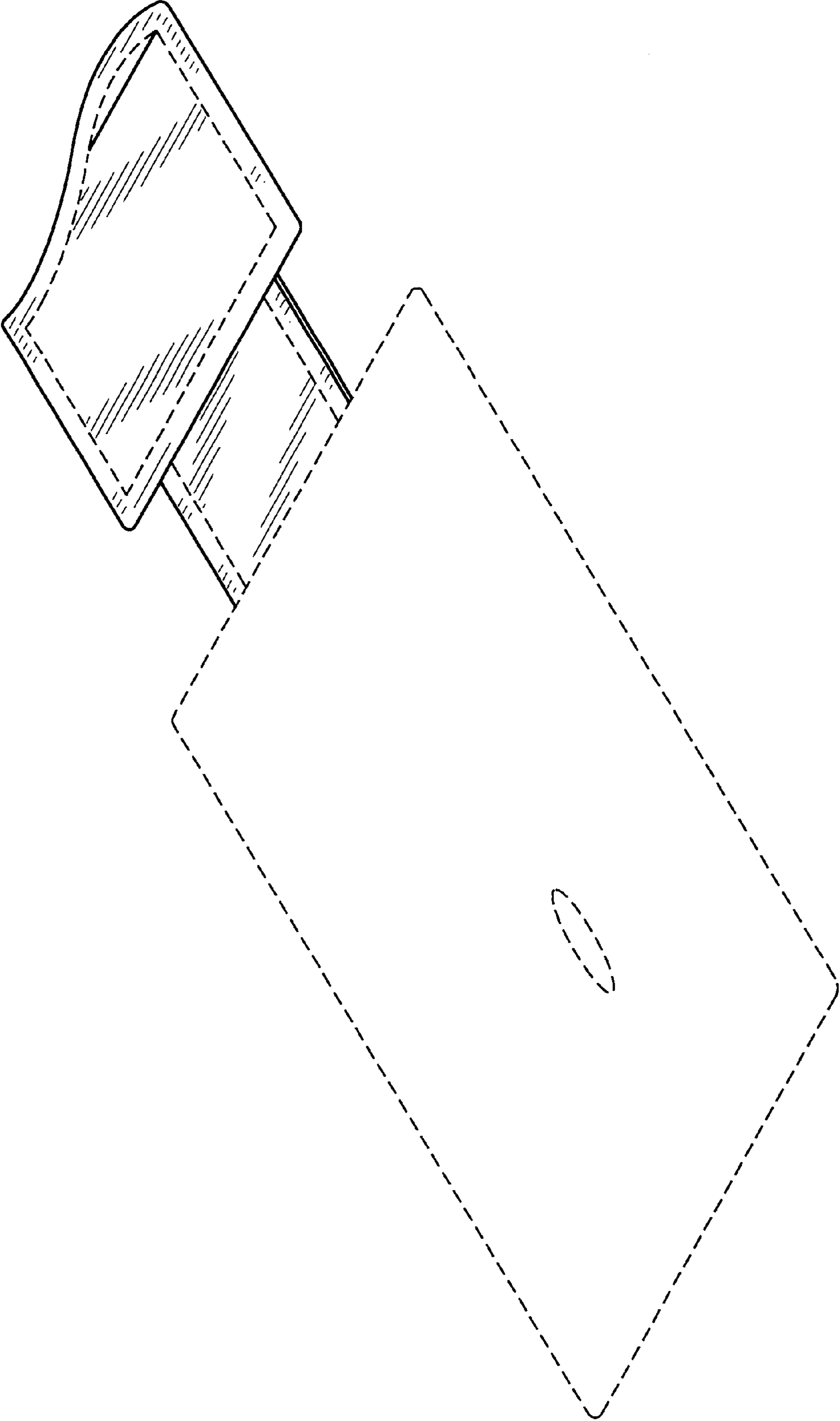

FIG. 1

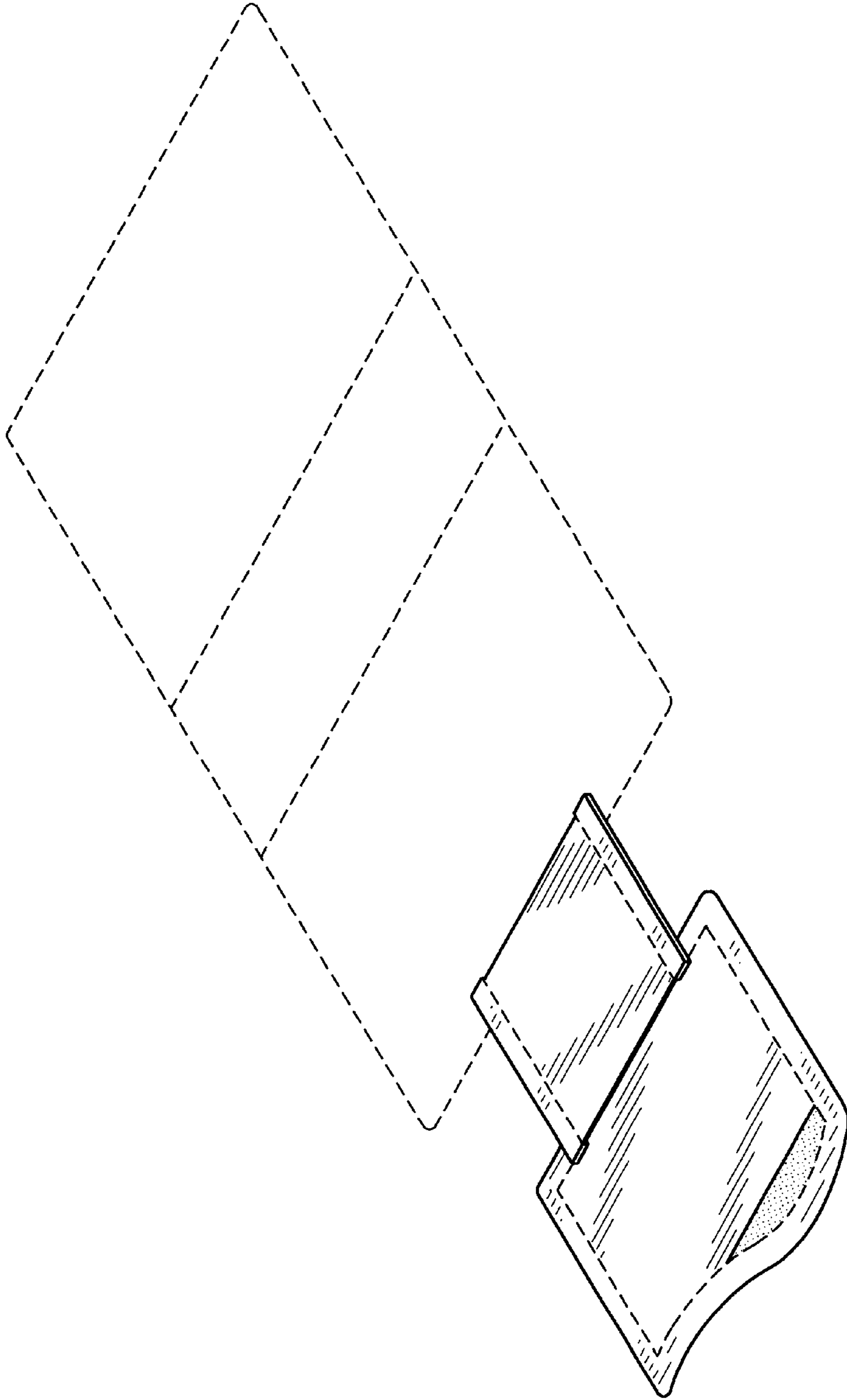

FIG. 2

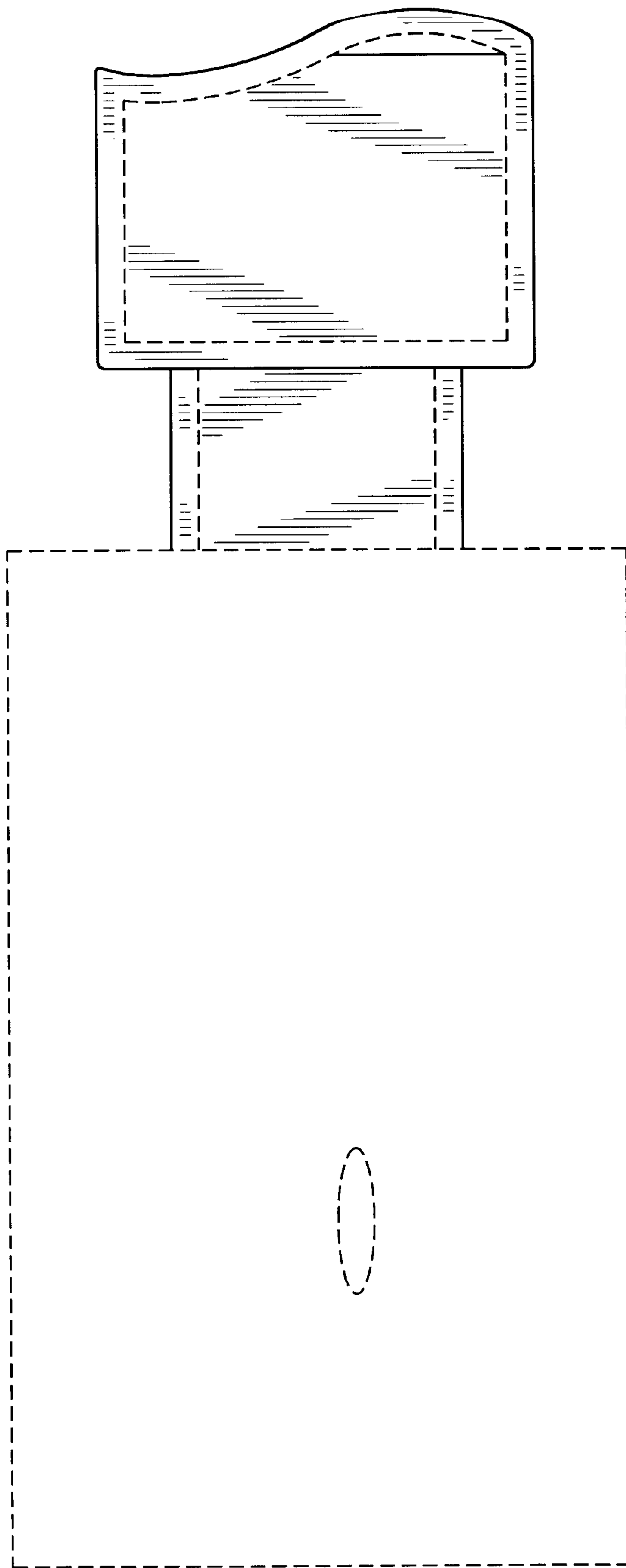

FIG. 3

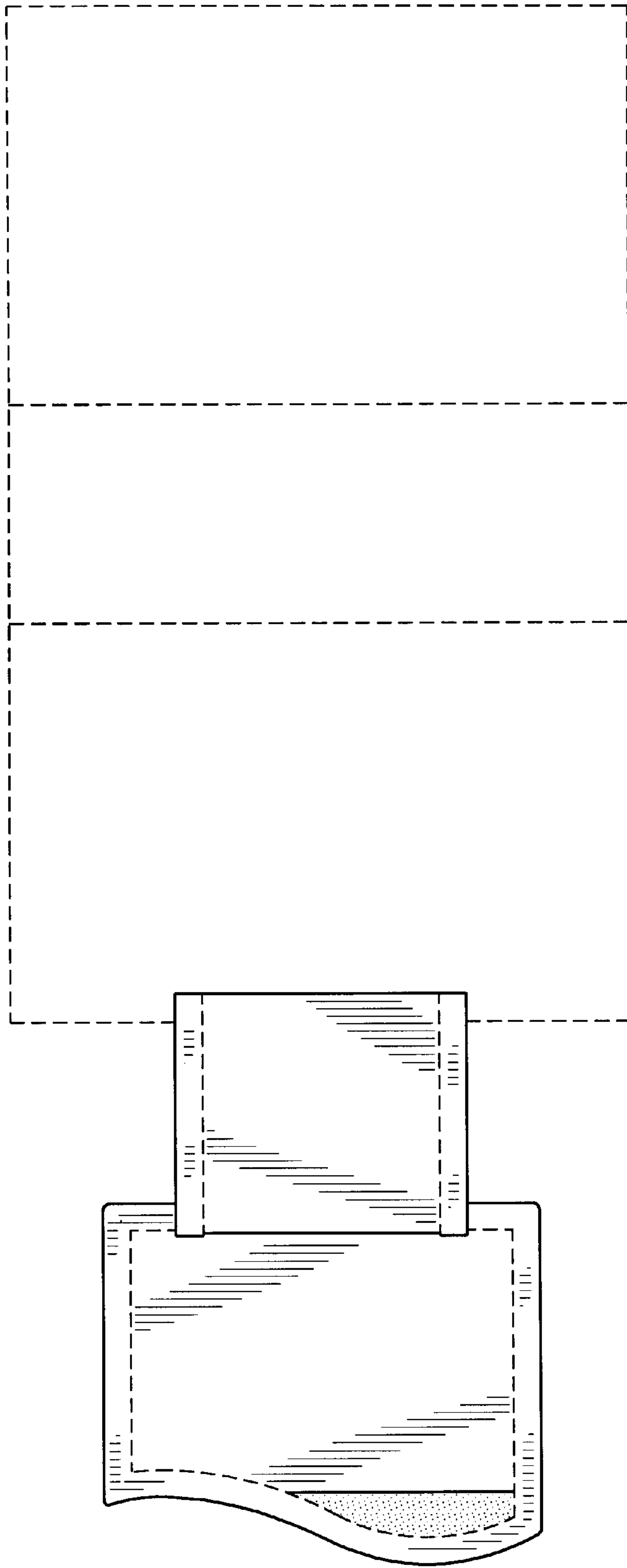

FIG. 4

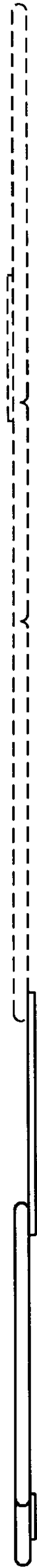

FIG. 5

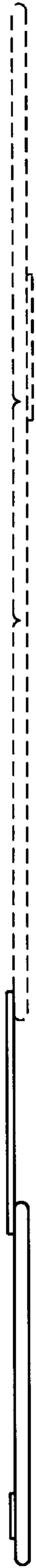

FIG. 6



FIG. 8

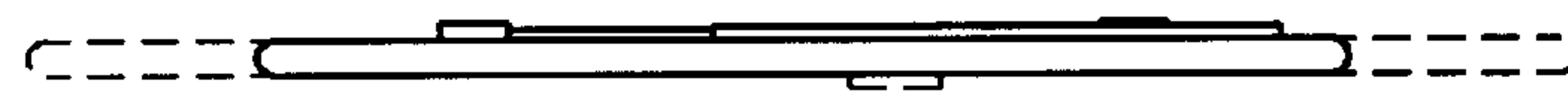

FIG. 7