



US00D528930S

(12) **United States Design Patent**  
**Degen**

(10) **Patent No.:** **US D528,930 S**

(45) **Date of Patent:** **\*\* Sep. 26, 2006**

(54) **POCKET JIG**

(75) Inventor: **Klemens Degen**, Weibern (DE)

(73) Assignee: **wolcraft GmbH**, Kempenich (DE)

(\*\*) Term: **14 Years**

(21) Appl. No.: **29/217,383**

(22) Filed: **Nov. 16, 2004**

(51) **LOC (8) Cl.** ..... **10-04**

(52) **U.S. Cl.** ..... **D10/65**

(58) **Field of Classification Search** ..... D10/65;  
408/1 R, 7, 72 R, 87, 103, 108, 115

See application file for complete search history.

(56) **References Cited**

**U.S. PATENT DOCUMENTS**

2,825,143	A	*	3/1958	Polivka	.....	408/72	R
4,955,766	A		9/1990	Sommerfeld			
5,024,564	A	*	6/1991	Lloyd	.....	408/72	R
5,230,592	A	*	7/1993	Degen et al.	.....	408/115	R
5,322,396	A		6/1994	Blacker			
5,676,500	A		10/1997	Sommerfeld			

5,743,684	A	*	4/1998	Rex	.....	408/115	R
6,254,320	B1		7/2001	Weinstein et al.			
6,394,712	B1		5/2002	Weinstein et al.			
6,481,937	B1		11/2002	Sommerfeld et al.			
2002/0150434	A1		10/2002	Sommerfeld et al.			

\* cited by examiner

*Primary Examiner*—Antoine D. Davis

*Assistant Examiner*—Patricia Palasik

(74) *Attorney, Agent, or Firm*—Everest Intellectual Property Law Group; Michael S. Leonard

(57) **CLAIM**

The ornamental design for a pocket jig, as shown and described.

**DESCRIPTION**

FIG. 1 is a front view of a pocket jig of the claimed design. FIG. 2 is a left side view of the pocket jig of FIG. 1. FIG. 3 is a back side view of the pocket jig of FIG. 1. FIG. 4 is a right side view of the pocket jig of FIG. 1. FIG. 5 is a top view of the pocket jig of FIG. 1. FIG. 6 is a bottom view of the pocket jig of FIG. 1; and, FIG. 7 is a perspective view of the pocket jig of FIG. 1.

**1 Claim, 4 Drawing Sheets**

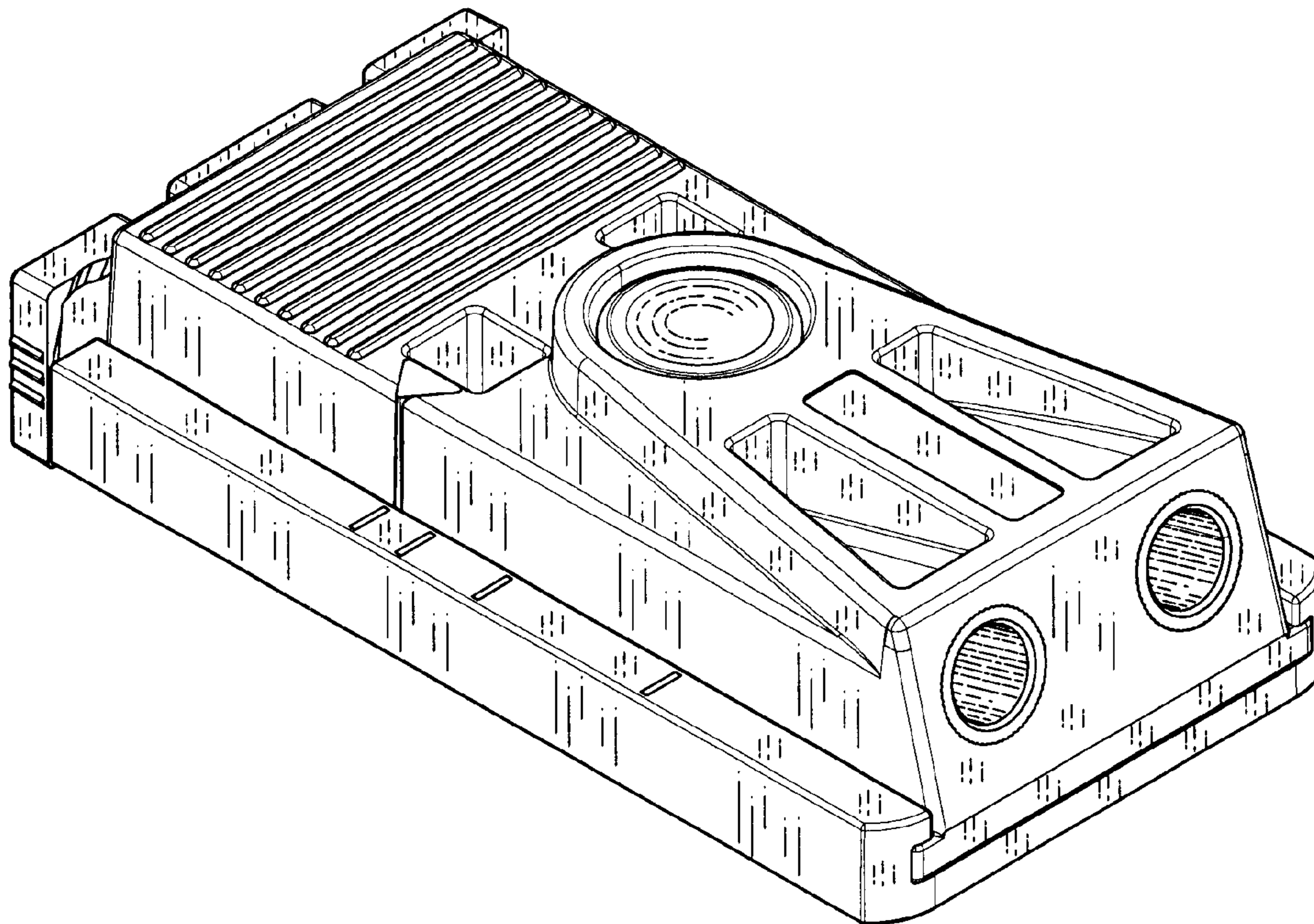

***Fig. 1***

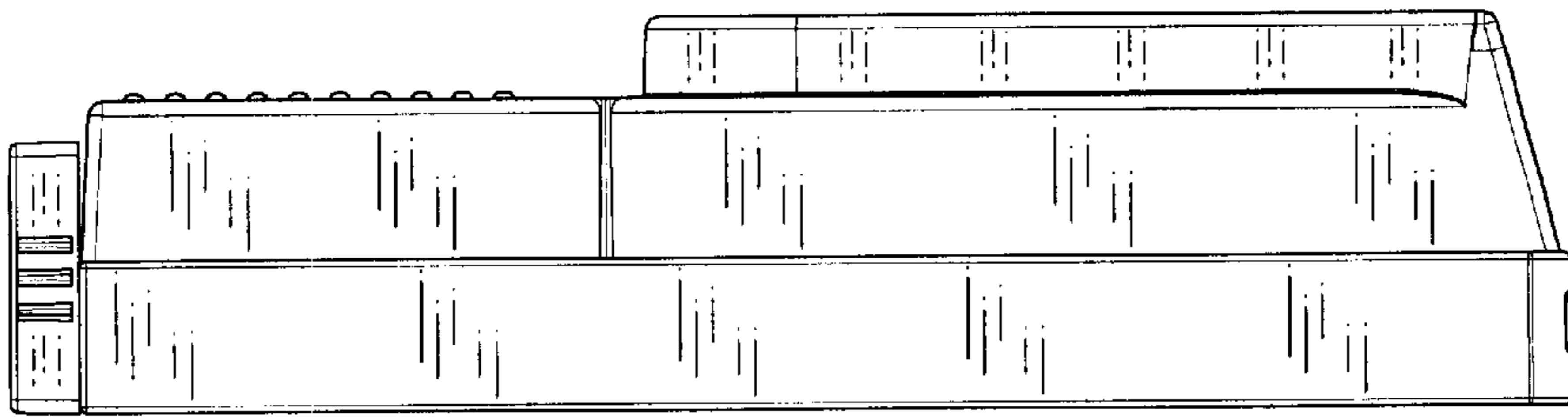

***Fig. 2***

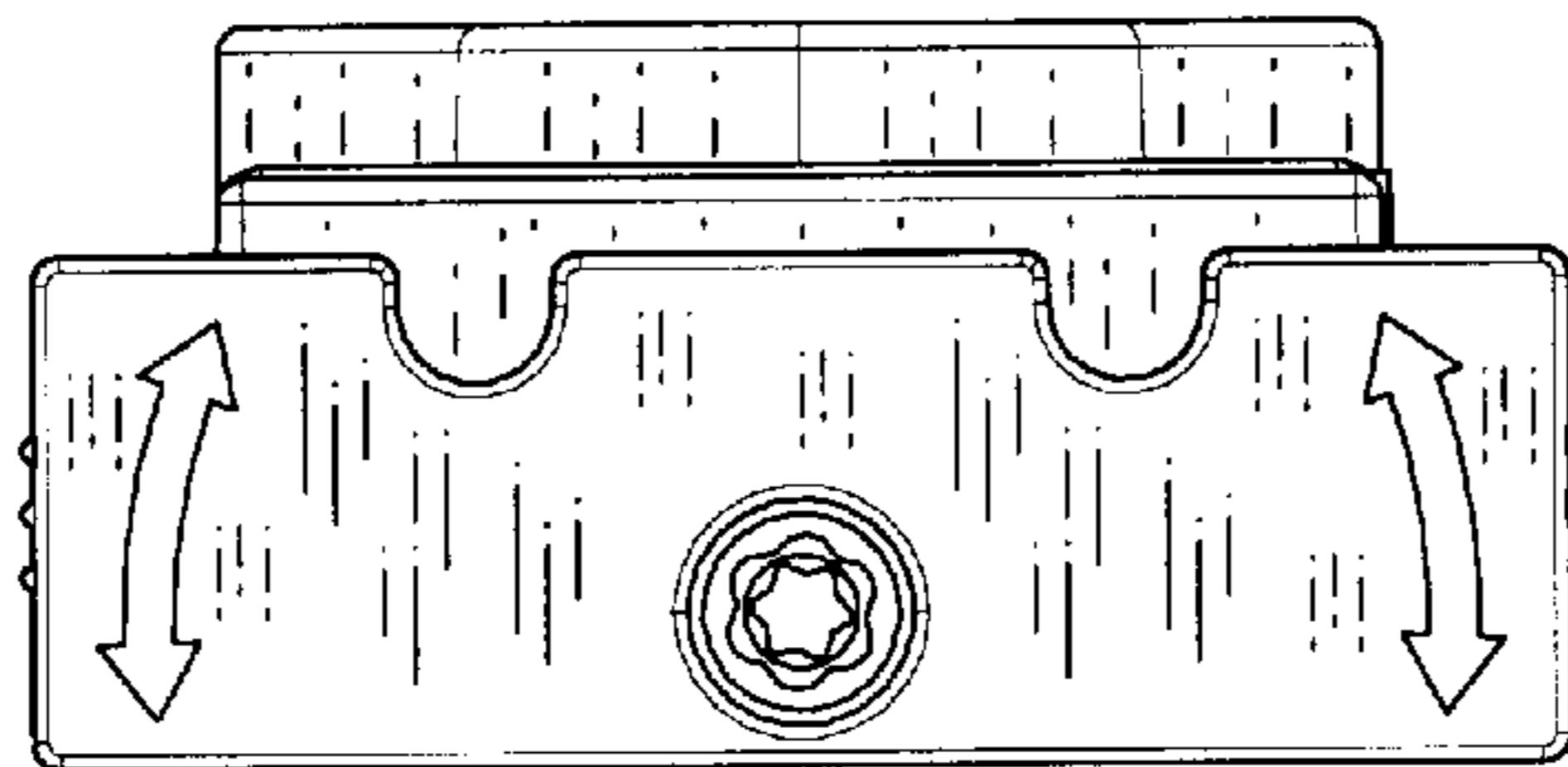

***Fig. 3***

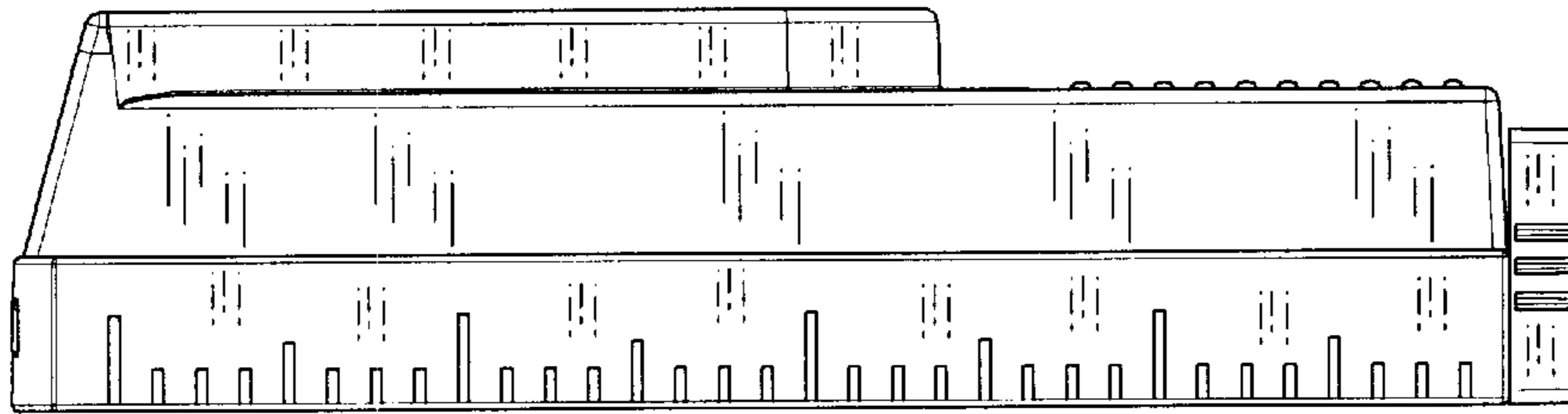

***Fig. 4***

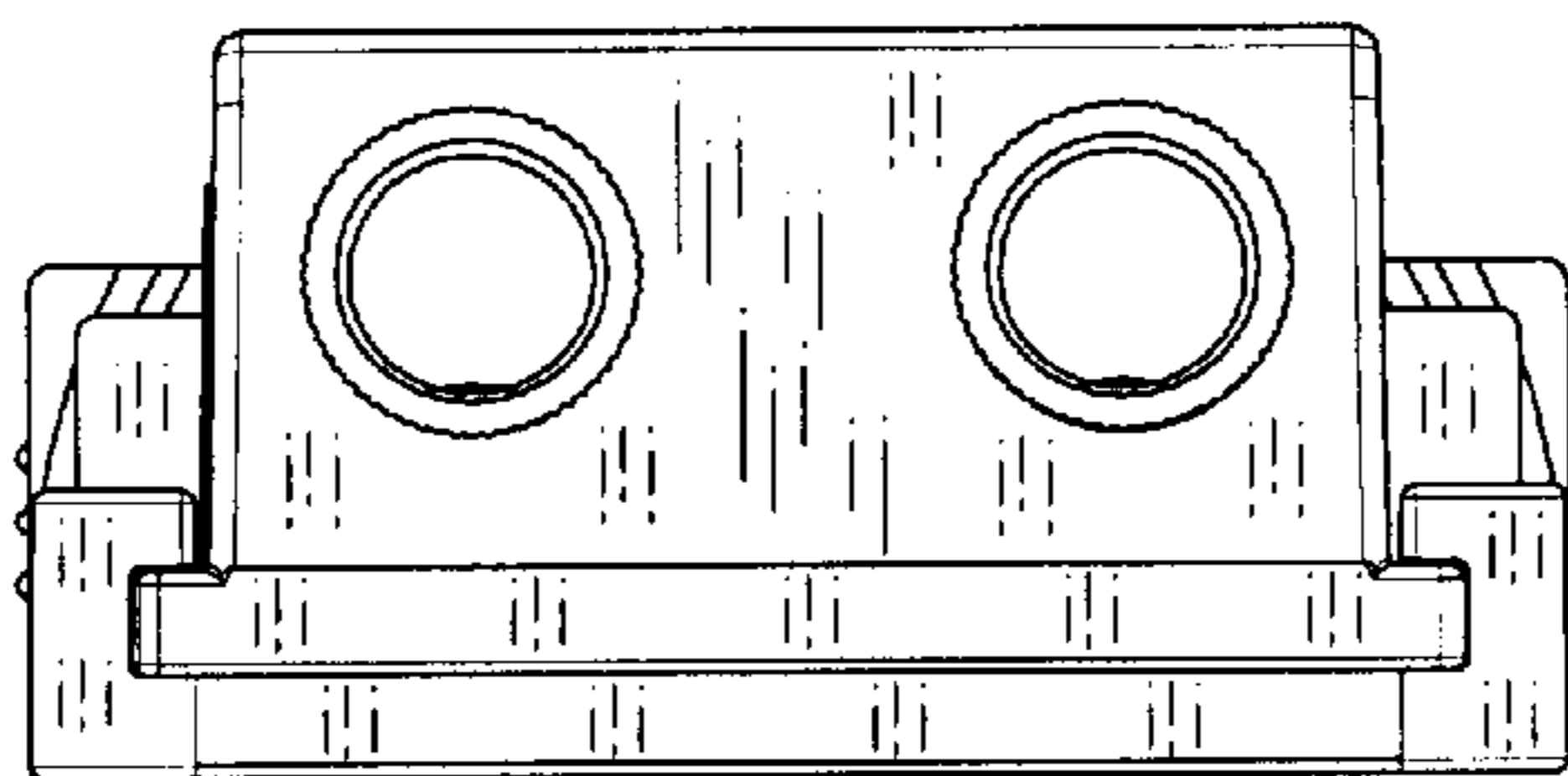

***Fig. 5***

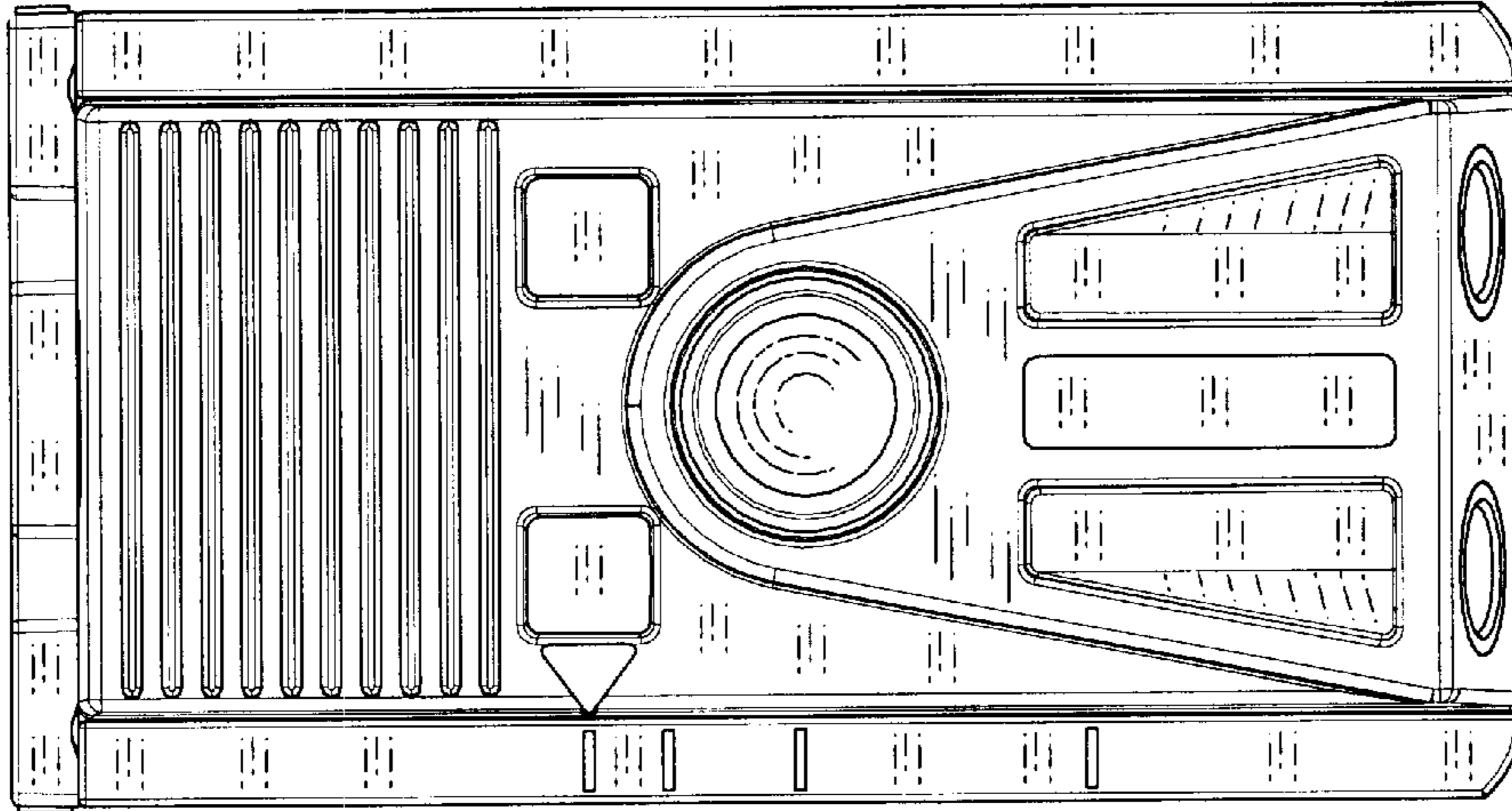

***Fig. 6***

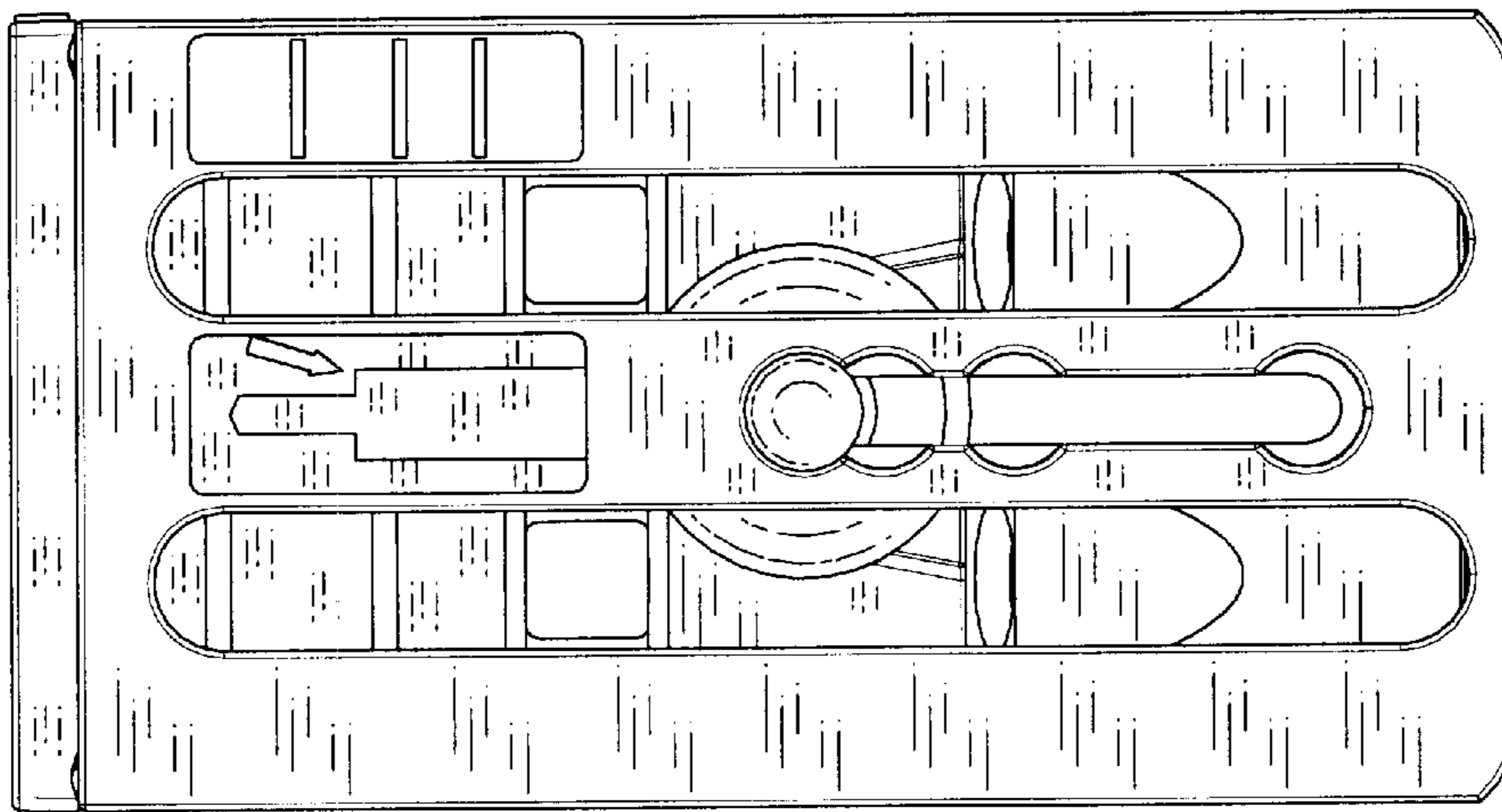

***Fig. 7***

