



US00D528907S

(12) **United States Design Patent**
Meehan

(10) **Patent No.:** **US D528,907 S**

(45) **Date of Patent:** **** Sep. 26, 2006**

(54) **STORAGE BOX HAVING A RETENTION PORTION WITH WINDOW**

D335,821 S * 5/1993 Detert et al. D9/418
D336,241 S * 6/1993 Detert et al. D9/418
D336,242 S * 6/1993 Detert et al. D9/418
D337,268 S * 7/1993 Detert et al. D9/418

(76) Inventor: **Madeline Meehan**, 111 Piermont St., Quincy, MA (US) 02170

* cited by examiner

(**) Term: **14 Years**

Primary Examiner—Stella Reid
Assistant Examiner—Derrick Holland

(21) Appl. No.: **29/256,166**

(74) *Attorney, Agent, or Firm*—William Nitkin

(22) Filed: **Mar. 17, 2006**

(57) **CLAIM**

Related U.S. Application Data

The ornamental design for a storage box having a retention portion with window, as shown and described.

(62) Division of application No. 29/243,466, filed on Nov. 25, 2005.

DESCRIPTION

(51) **LOC (8) Cl.** **09-03**

FIG. 1 is a front perspective view of a storage box having a retention portion with window, showing my new design;

(52) **U.S. Cl.** **D9/418**

FIG. 2 is a top plan view thereof;

(58) **Field of Classification Search** D9/418,

FIG. 3 is a bottom plan view thereof;

D9/414, 415, 424; D7/553, 553.2, 602, 605;

FIG. 4 is a right end view thereof;

206/45.26, 216, 218, 541, 738

FIG. 5 is a left end view thereof;

See application file for complete search history.

FIG. 6 is a left view thereof; and,

FIG. 7 is a right side view thereof.

The broken lines showing is for illustrative purposes only and forms no part of the claimed design.

(56) **References Cited**

U.S. PATENT DOCUMENTS

5,119,940 A * 6/1992 Grindrod 426/120

D335,445 S * 5/1993 Detert et al. D9/418

1 Claim, 4 Drawing Sheets

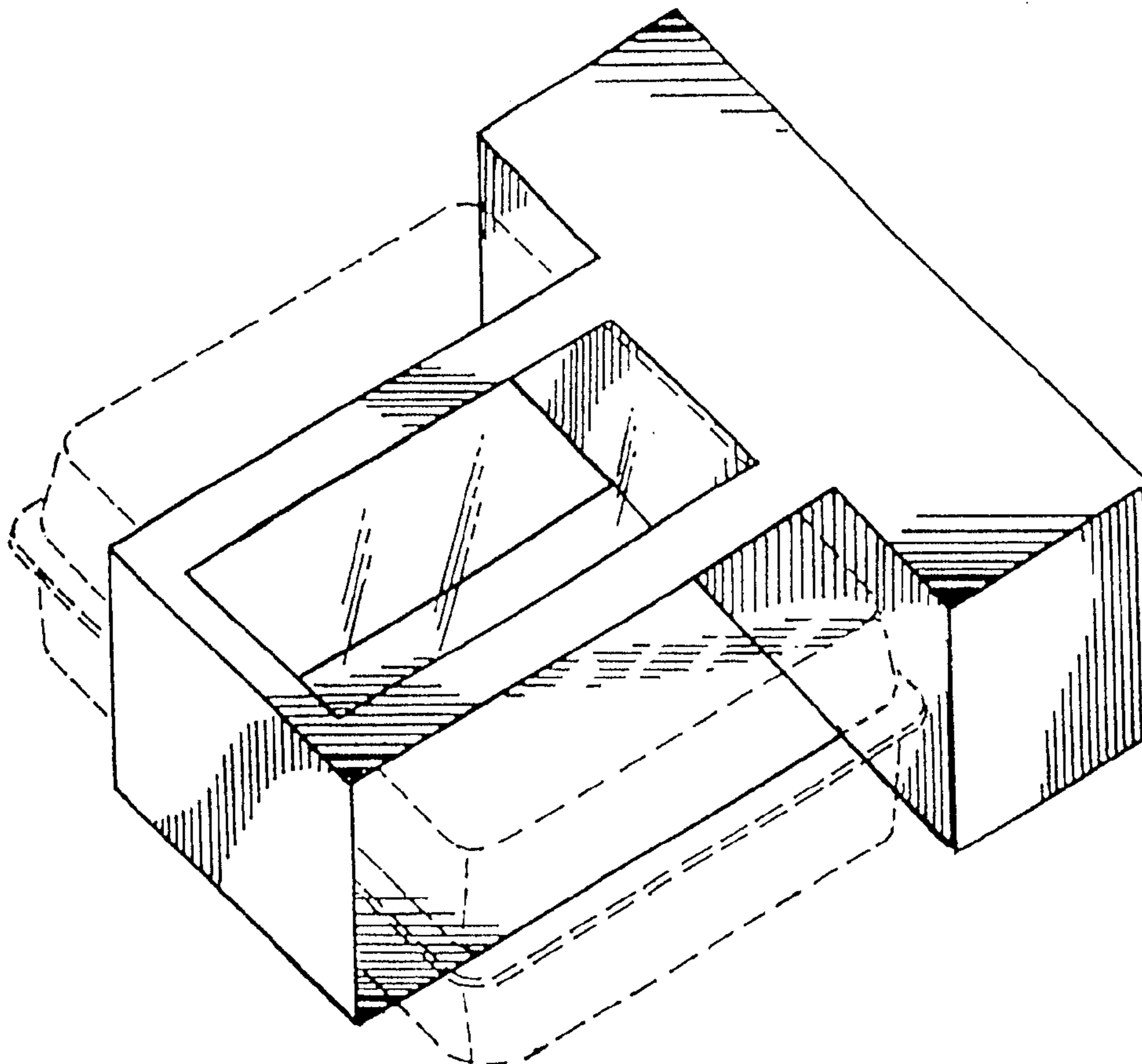

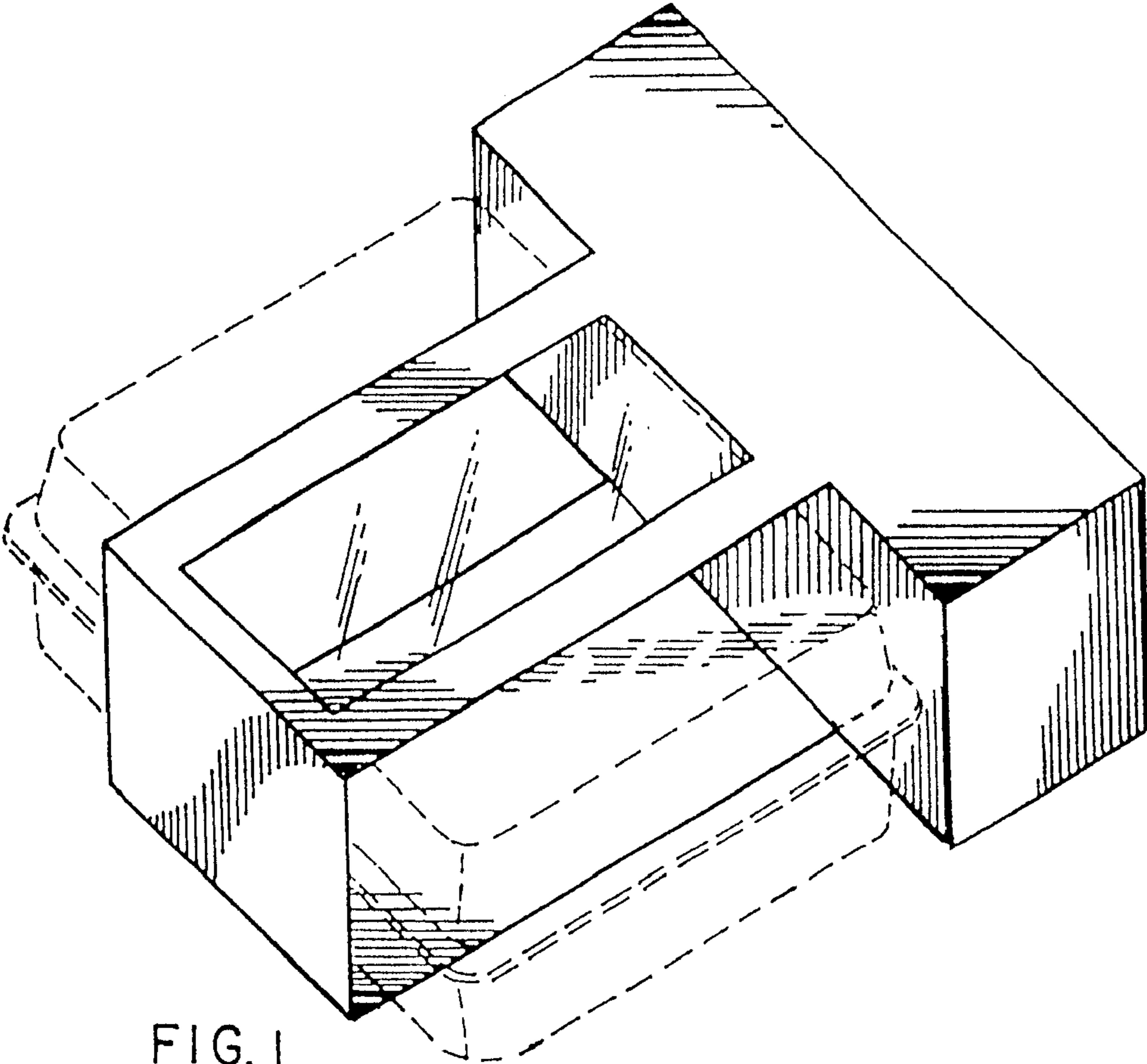

FIG. 1

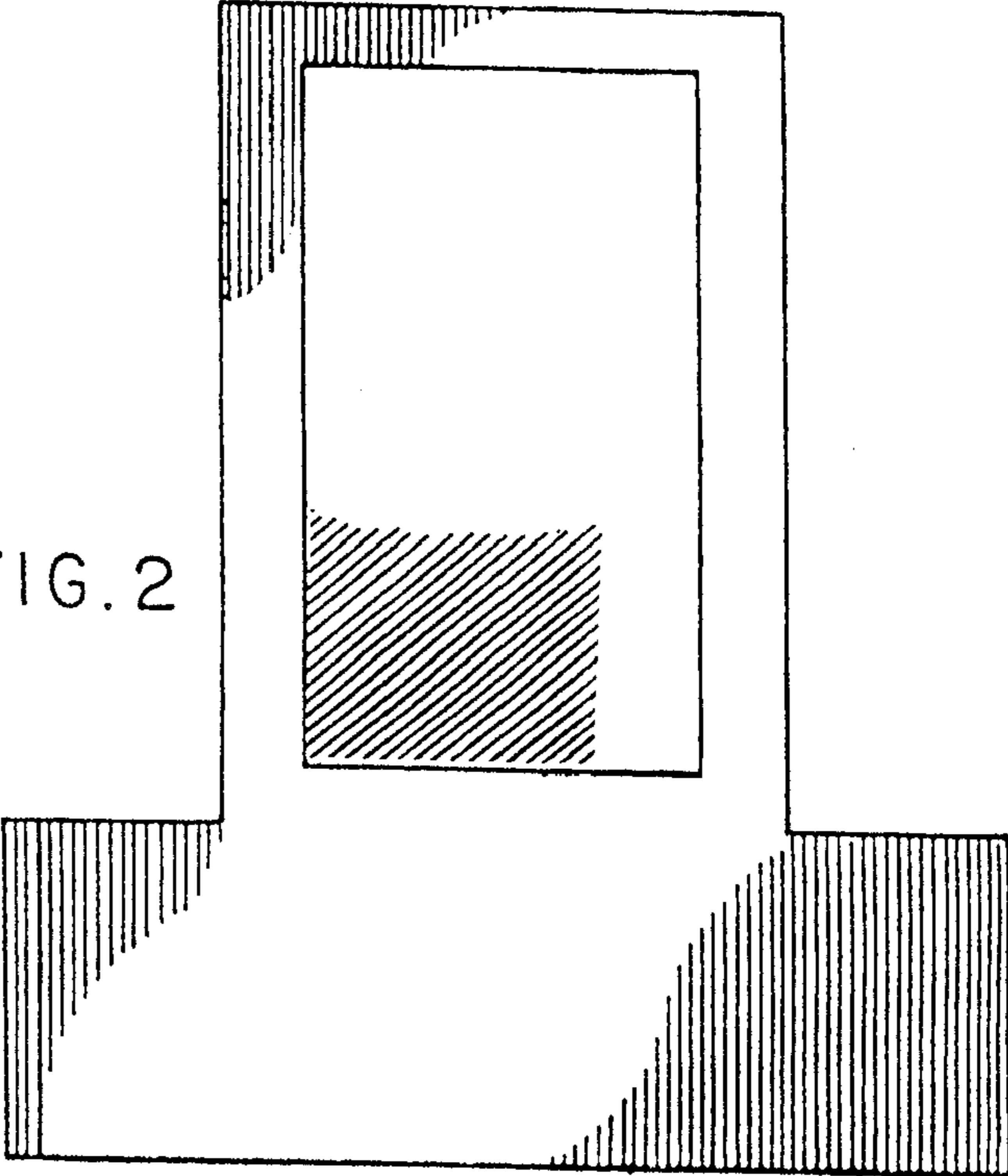

FIG. 2

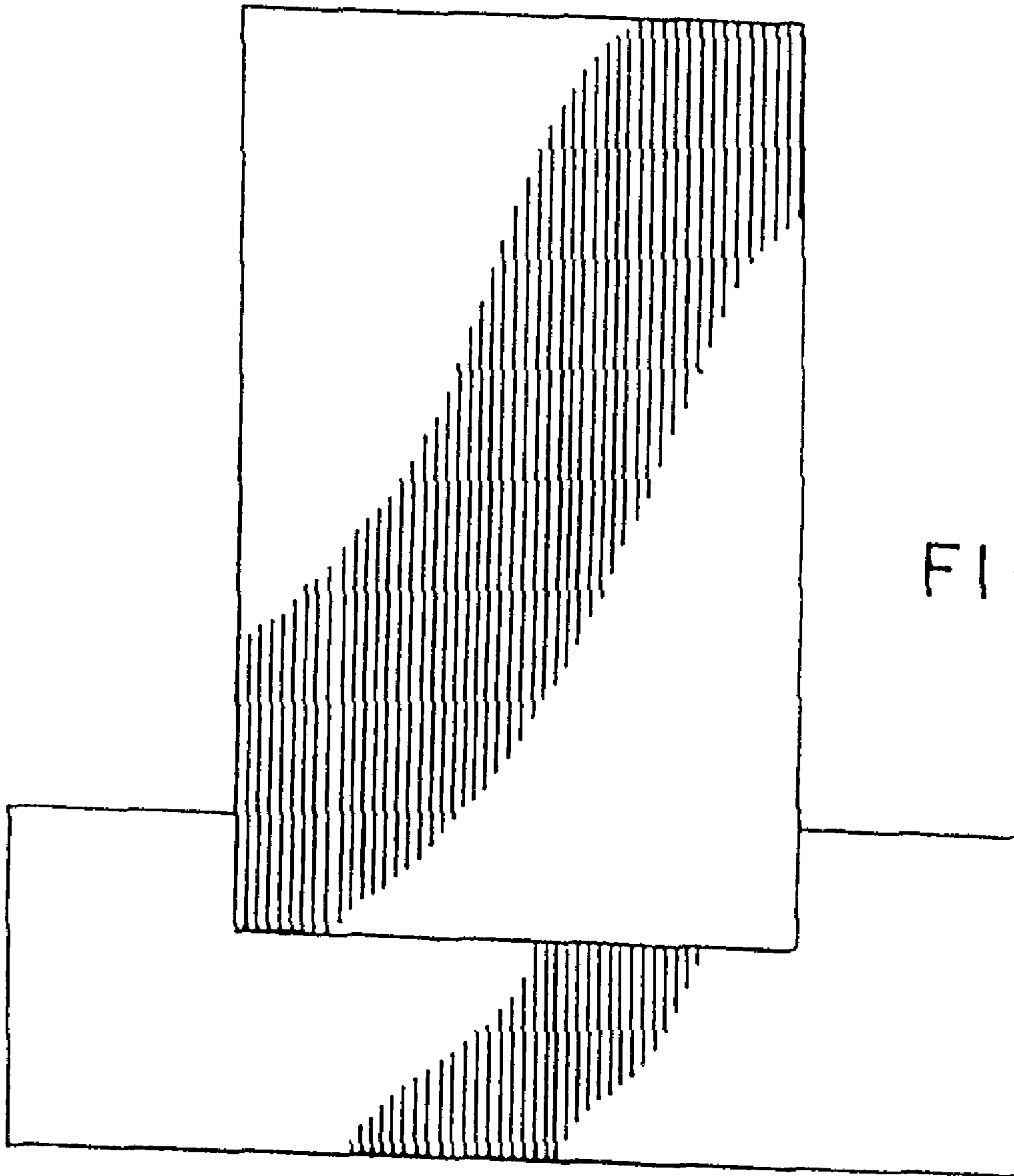

FIG. 3

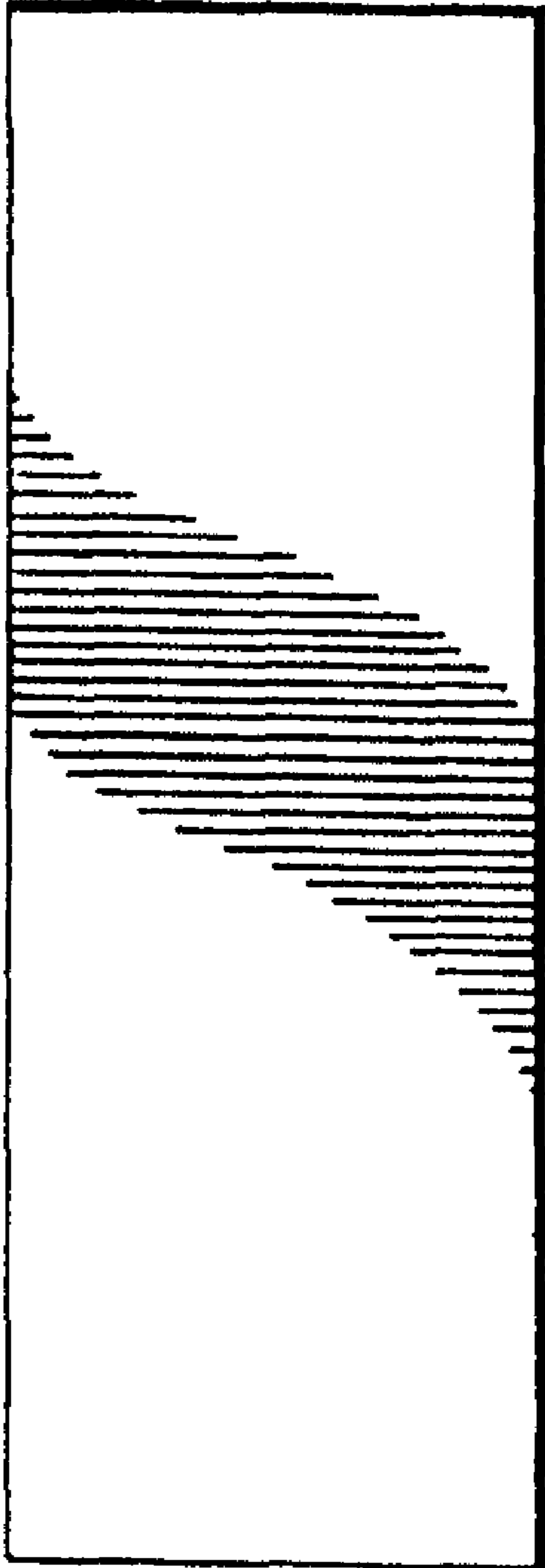

FIG. 4

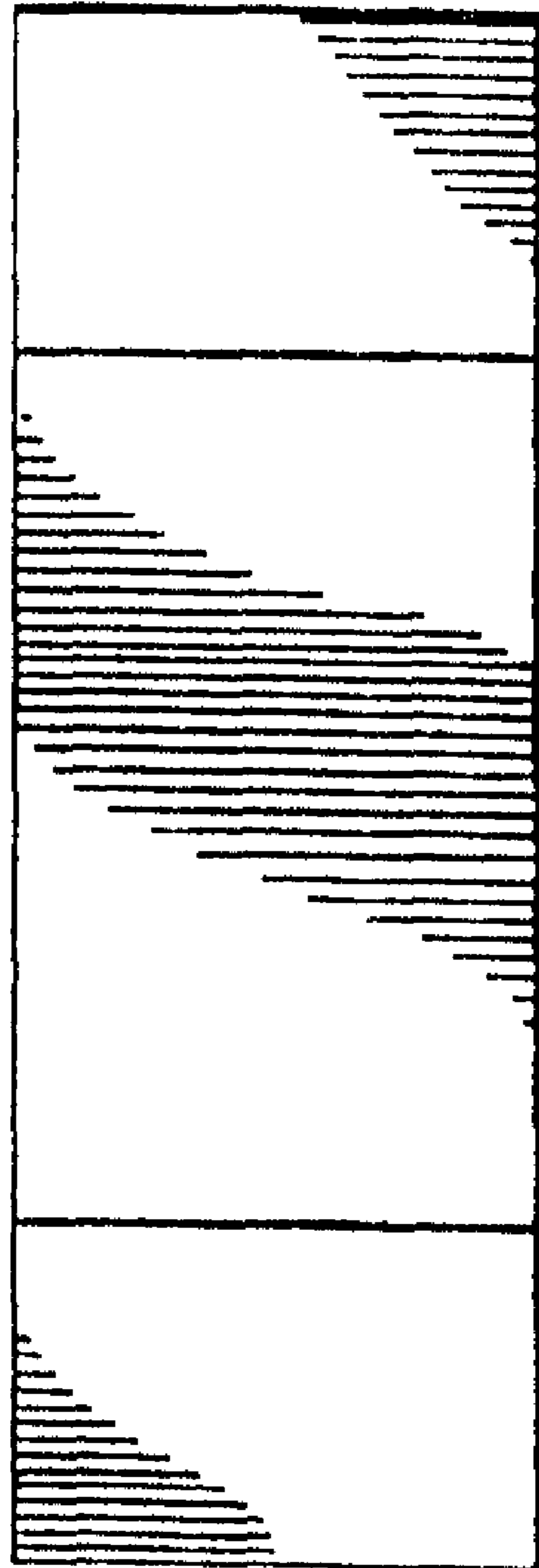

FIG. 5

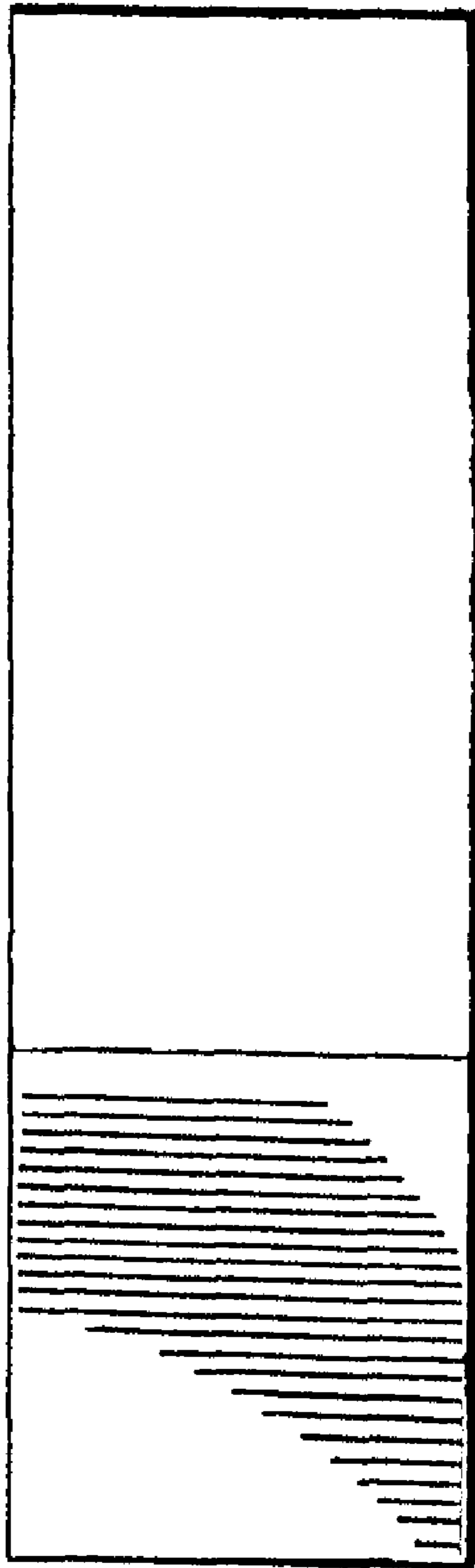

FIG. 6

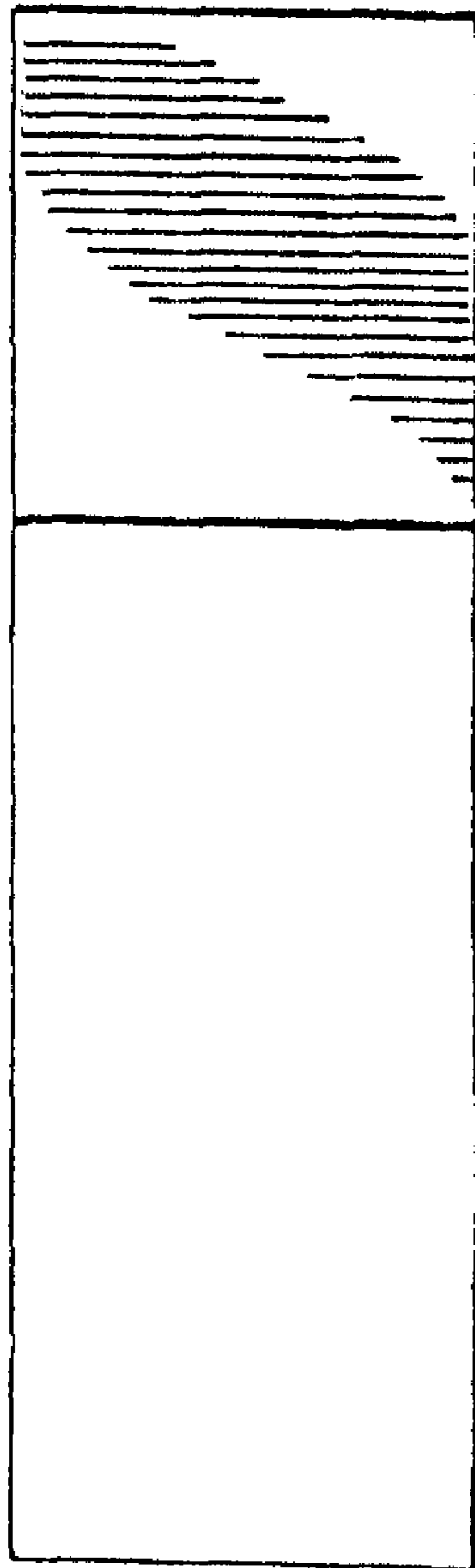

FIG. 7