



US00D528906S

(12) **United States Design Patent**
Harper et al.

(10) **Patent No.:** **US D528,906 S**

(45) **Date of Patent:** **** Sep. 26, 2006**

(54) **PACKAGE WITH A TRANSPARENT WINDOW**

(75) Inventors: **Richard Michael Harper**, Cincinnati, OH (US); **Jacqueline Denham**, Cincinnati, OH (US); **Jason Robert Phillips**, Cincinnati, OH (US); **Douglas Michael McGahan**, Milford, OH (US); **James Edward Poland**, Park Hills, KY (US)

(73) Assignee: **The Procter & Gamble Company**, Cincinnati, OH (US)

(**) Term: **14 Years**

(21) Appl. No.: **29/234,388**

(22) Filed: **Jul. 18, 2005**

(51) **LOC (8) Cl.** **09-03**

(52) **U.S. Cl.** **D9/418; D9/432**

(58) **Field of Classification Search** D9/418, D9/415, 416, 424, 432; 206/733, 769, 773, 206/775-777, 781-783; 229/162.1, 162.3, 229/162.6, 162.7

See application file for complete search history.

(56) **References Cited**

U.S. PATENT DOCUMENTS

3,245,526 A * 4/1966 Palmer 229/138

4,449,633 A * 5/1984 Johnson et al. 229/123.2
D297,415 S * 8/1988 Gavin et al. D9/416
D376,976 S * 12/1996 Eicke et al. D9/629
D446,114 S * 8/2001 Stephens D9/418
D447,685 S * 9/2001 Chagnon et al. D9/416
D455,956 S * 4/2002 Thompson et al. D9/418
D462,264 S * 9/2002 Barr et al. D9/416

* cited by examiner

Primary Examiner—Stella Reid

Assistant Examiner—Derrick Holland

(74) *Attorney, Agent, or Firm*—Thibault Fayette; Mark A. Charles; Kim W. Zerby

(57) **CLAIM**

The ornamental design for a package with a transparent window, as shown and described.

DESCRIPTION

FIG. 1 is a perspective view of a package with a transparent window, embodying the new design; FIG. 2 is a top view of thereof; FIG. 3 is a front view thereof; FIG. 4 is a back view thereof; FIG. 5 is a left side view thereof; FIG. 6 is a right side view thereof; and, FIG. 7 is a bottom view thereof.

1 Claim, 2 Drawing Sheets

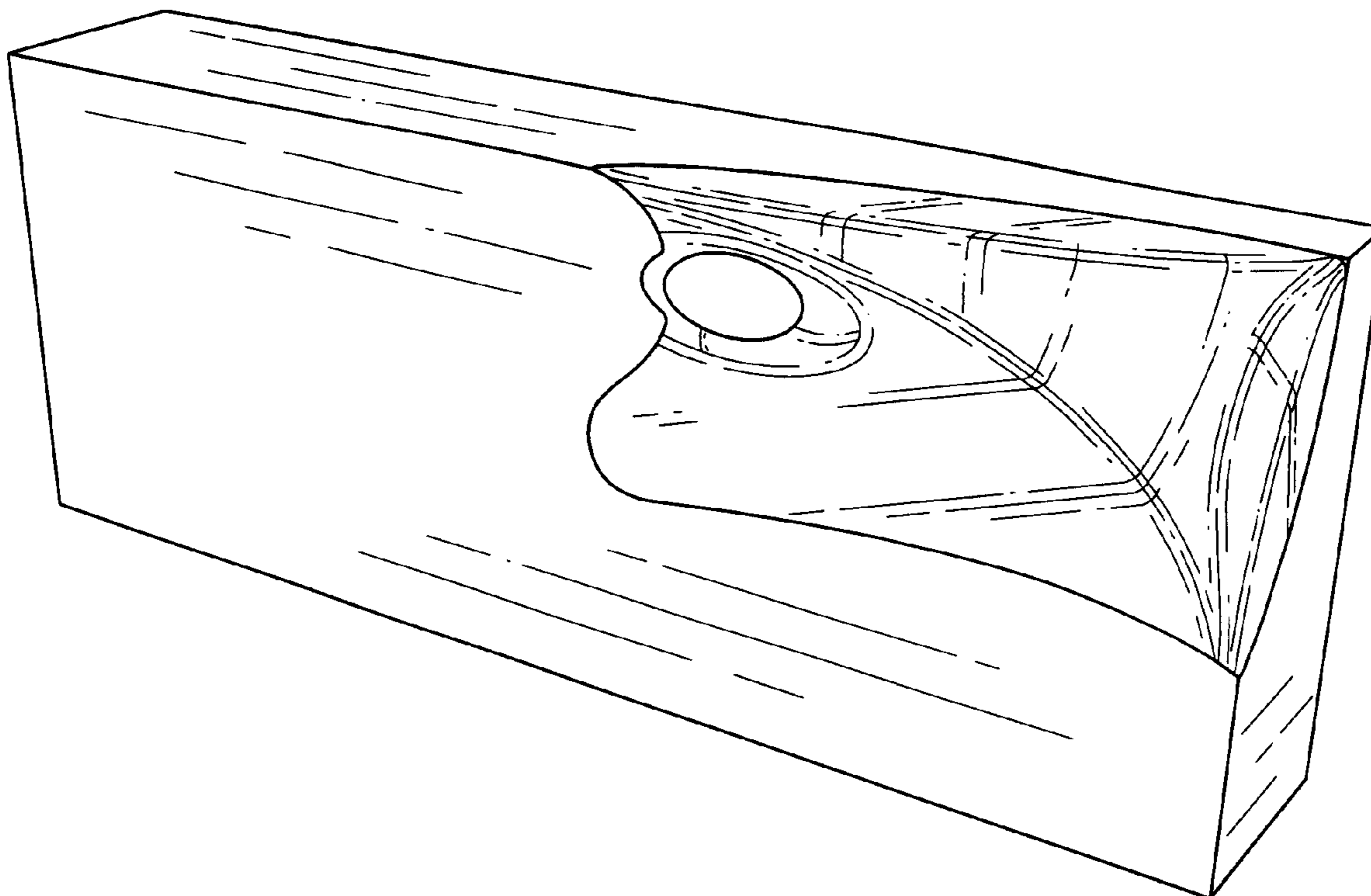

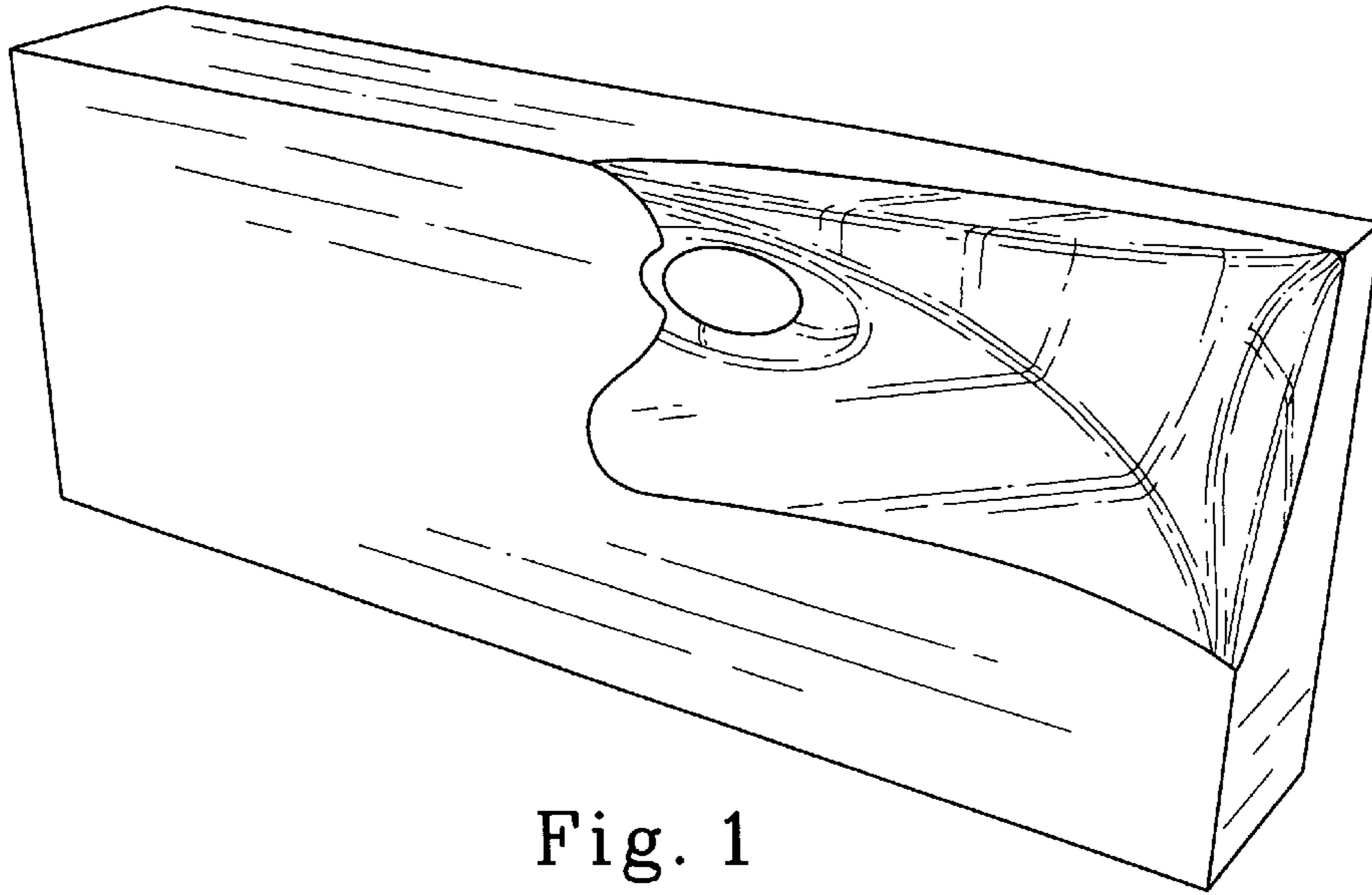

Fig. 1

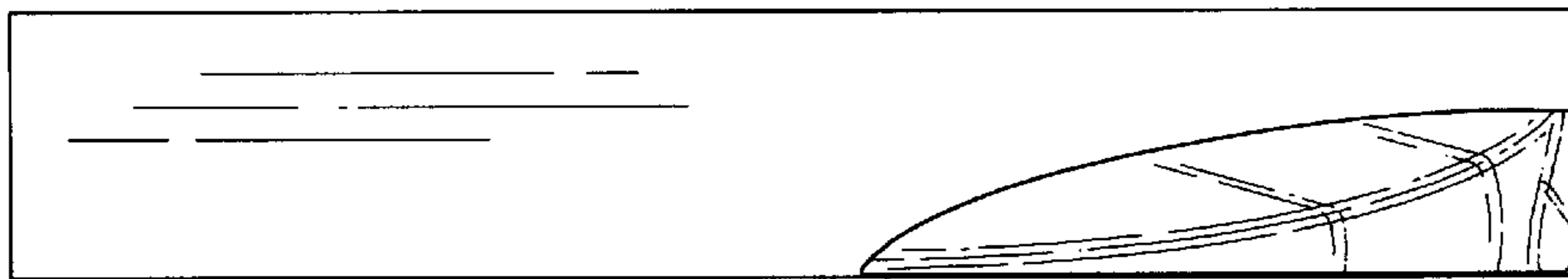

Fig. 2

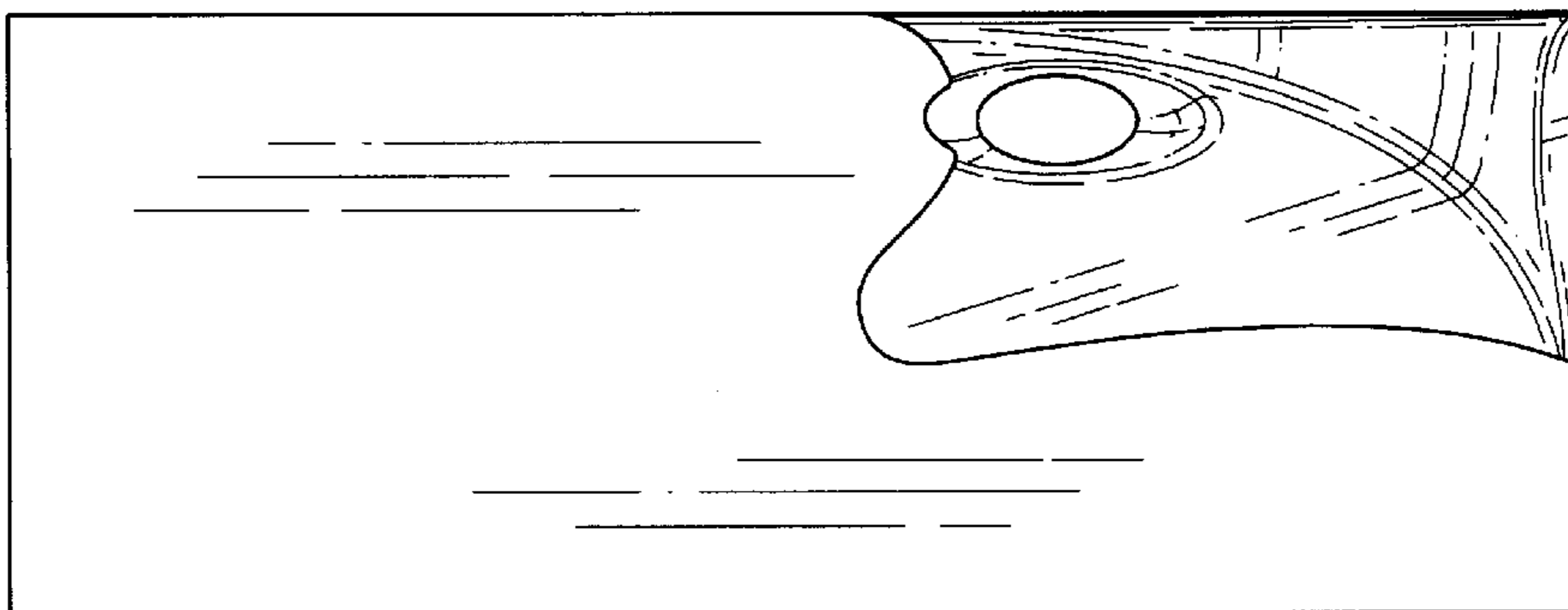

Fig. 3

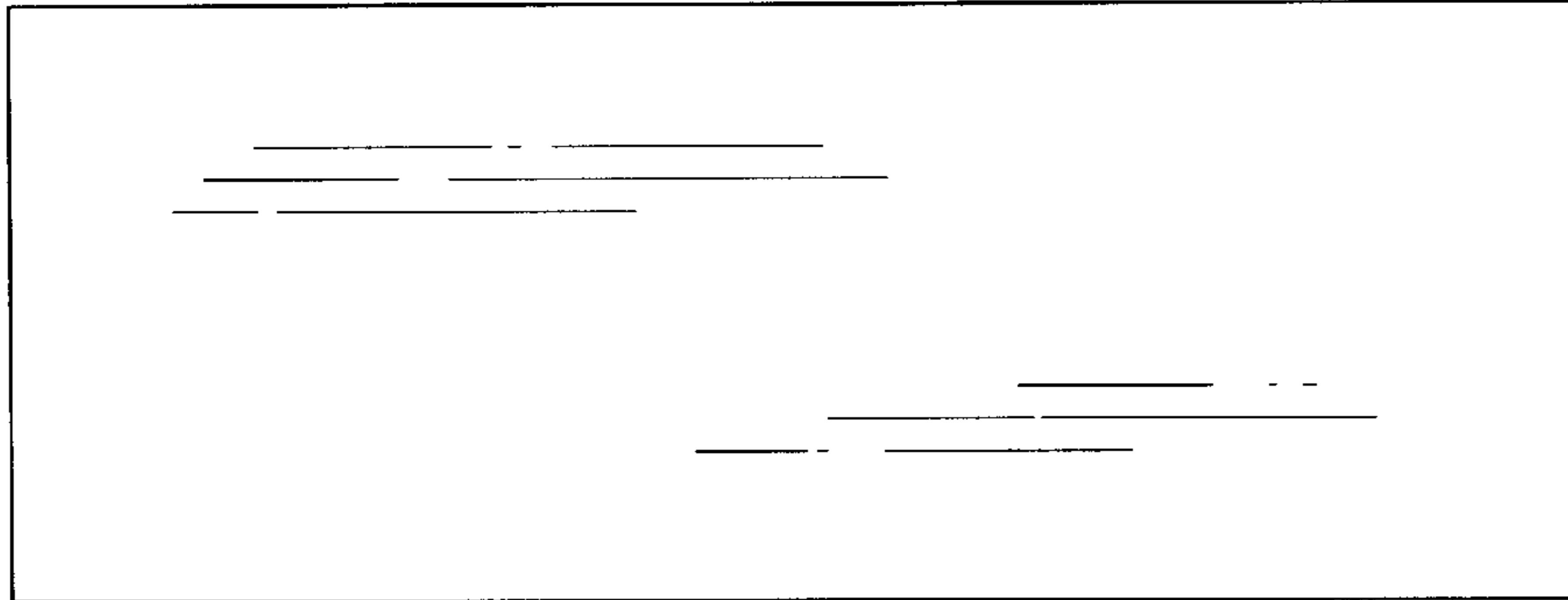

Fig. 4

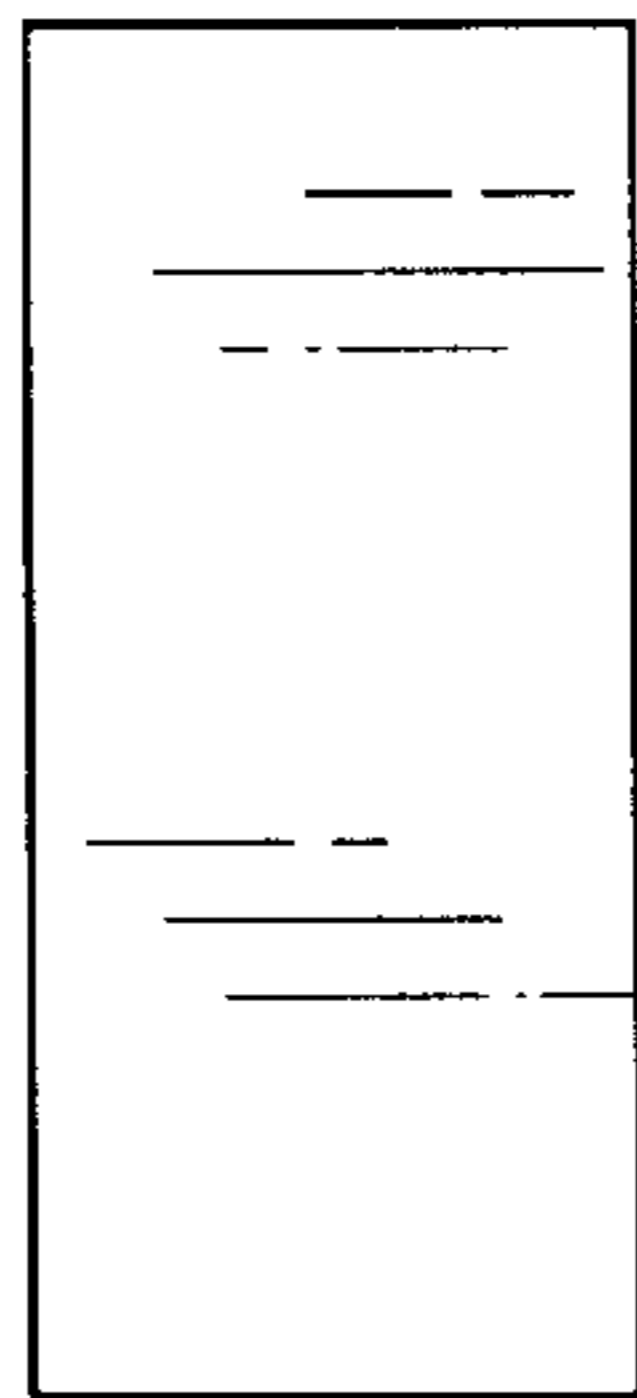

Fig. 5

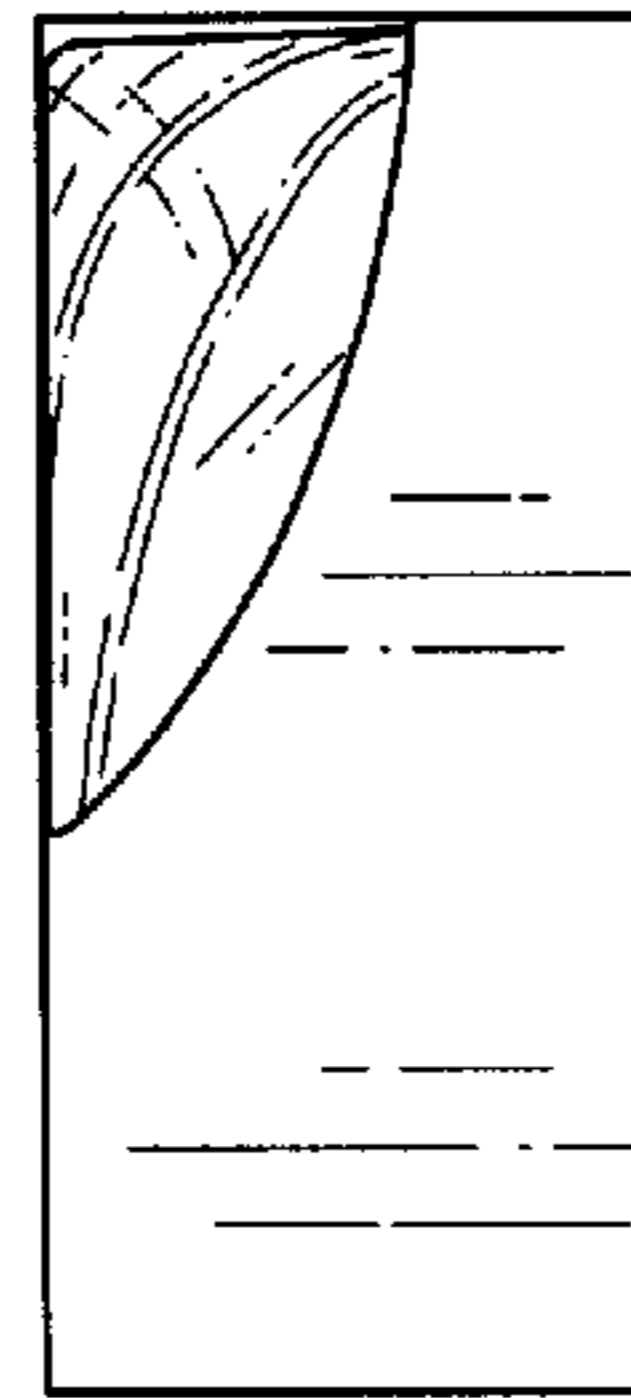

Fig. 6

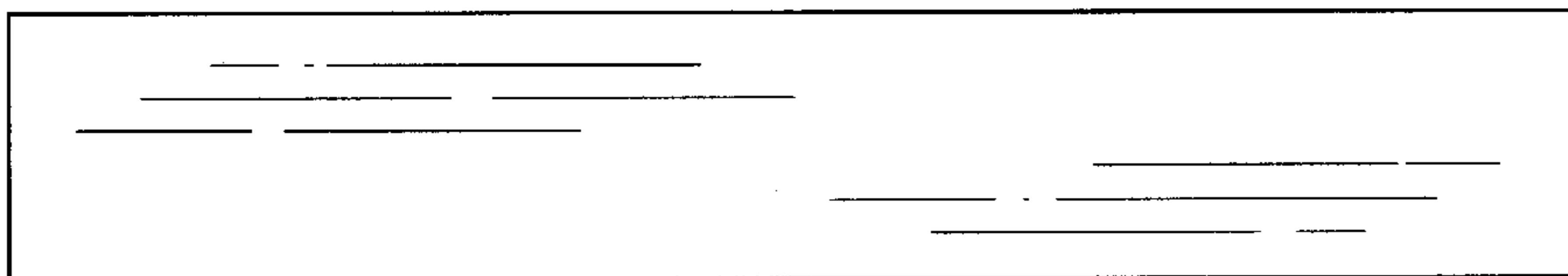

Fig. 7