



US00D528895S

(12) **United States Design Patent**  
**Ping**

(10) **Patent No.: US D528,895 S**

(45) **Date of Patent: \*\* \*Sep. 26, 2006**

(54) **UTILITY KNIFE**

FOREIGN PATENT DOCUMENTS

(75) Inventor: **Qiu Jian Ping**, Hangzhou (CN)

CN 02-2-88379.7 12/2002

(73) Assignee: **Great Neck Saw Manufactures, Inc.**,  
Mineola, NY (US)

CN 200420008852.7 3/2004

CN 200420008854.6 3/2004

CN 200420020589.3 3/2004

CN 200420020590.6 3/2004

CN 200420020591.0 3/2004

(\* ) Notice: This patent is subject to a terminal disclaimer.

*Primary Examiner*—Philip S. Hyder

(\*\*) Term: **14 Years**

(74) *Attorney, Agent, or Firm*—Joseph J. Previto

(21) Appl. No.: **29/215,270**

(57) **CLAIM**

(22) Filed: **Oct. 15, 2004**

The ornamental design for a utility knife, substantially as shown and described.

**Related U.S. Application Data**

**DESCRIPTION**

(60) Continuation-in-part of application No. 29/203,849, filed on Apr. 20, 2004, now Pat. No. Des. 510,250, which is a division of application No. 29/181,557, filed on May 13, 2003, now Pat. No. Des. 495,939.

FIG. 1 is a perspective view of my new design.

FIG. 2 is a top view thereof.

FIG. 3 is a side view thereof.

FIG. 4 is a front view thereof.

FIG. 5 is a rear view thereof.

FIG. 6 is a bottom view thereof.

FIG. 7 is another side view thereof.

FIG. 8 is a side view showing the knife in a partially folded position.

FIG. 9 is a side view showing the handle in a fully folded position.

FIG. 10 is a perspective view of another embodiment of my new design.

FIG. 11 is a top view thereof.

FIG. 12 is a side view thereof.

FIG. 13 is a front view thereof.

FIG. 14 is a rear view thereof.

FIG. 15 is a bottom view thereof.

FIG. 16 is another side view thereof.

FIG. 17 is a side view showing the knife in a partially folded position; and,

FIG. 18 is a side view showing the knife in a fully folded position.

The broken line portions of the disclosure are for illustrative purposes only and form no part of the claimed design.

(51) **LOC (8) Cl.** ..... **08-03**

(52) **U.S. Cl.** ..... **D8/99**

(58) **Field of Classification Search** ..... D8/99,  
D8/98, 107, 105; 30/154, 155, 156, 157,  
30/159, 158, 161, 162, 330  
See application file for complete search history.

(56) **References Cited**

U.S. PATENT DOCUMENTS

97,154 A	11/1869	Barnard
493,075 A	3/1893	Evertz
515,045 A	2/1894	Bultzingslowen
584,077 A	6/1897	Jackson
596,096 A	12/1897	Watts
988,068 A	3/1911	Beardsley
1,362,142 A	12/1920	Rohrer
1,444,324 A	2/1923	Brooks
1,706,251 A	3/1929	Perry
1,750,517 A	3/1930	DeBracht
2,134,973 A	11/1938	Harwell
2,265,775 A	12/1941	McNamara
2,284,128 A	5/1942	Bush

(Continued)

**1 Claim, 8 Drawing Sheets**

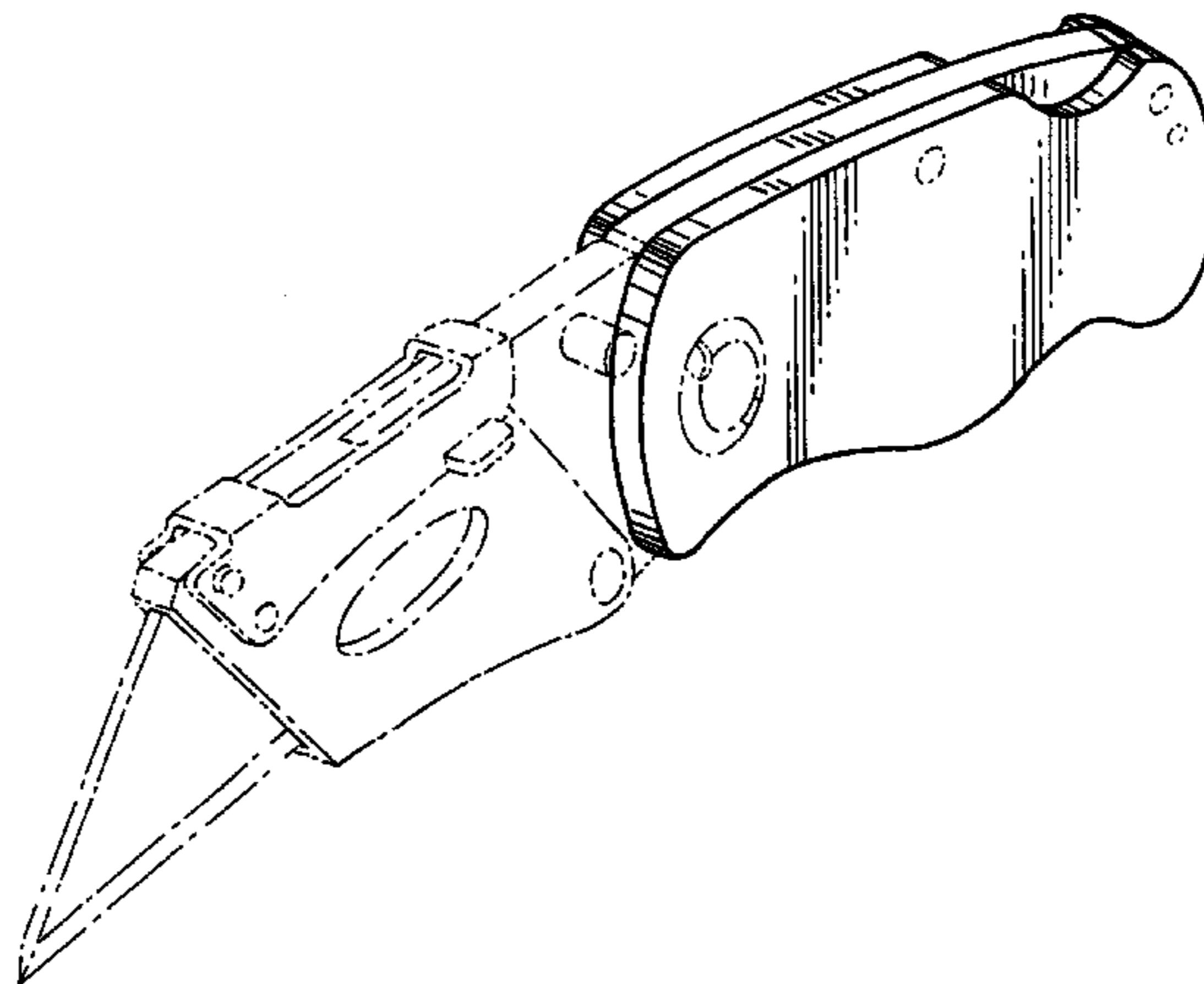

# US D528,895 S

Page 2

U.S. PATENT DOCUMENTS					
			5,511,310 A	4/1996	Sessions
			5,769,094 A	6/1998	Jenkins, Jr.
2,523,575 A	9/1950	Kassel	5,815,927 A	10/1998	Collins
2,914,850 A	12/1959	Kuhnl	5,826,340 A	10/1998	Hull
2,980,996 A	4/1961	Beran	5,909,930 A	6/1999	Ragland
3,306,297 A	2/1967	Voorhees	5,966,816 A	10/1999	Roberson
3,568,315 A	3/1971	Smith	5,979,059 A	11/1999	Leatherman
3,593,417 A	7/1971	West	6,170,104 B1	1/2001	Seber
3,872,591 A	3/1975	Quenot	6,170,158 B1	1/2001	Daily
4,017,969 A	4/1977	Stonebraker	6,256,887 B1	7/2001	Osborne
4,040,181 A	8/1977	Johnson	6,256,888 B1	7/2001	Shuen
4,261,104 A	4/1981	Cuscovitch	6,263,581 B1	7/2001	Forte
4,347,665 A	9/1982	Glesser	6,354,007 B1	3/2002	Scarla
4,442,600 A	4/1984	Felix-Dalichow	6,370,778 B1	4/2002	Conable
4,570,341 A	2/1986	Konneker	6,446,341 B1	9/2002	Wang
4,604,805 A	8/1986	Krieger	6,487,740 B1	12/2002	Seber
4,665,615 A	5/1987	Martinez	6,574,868 B1	6/2003	Overholt
4,669,188 A	6/1987	Evrell	6,688,003 B1	2/2004	Scarla
4,719,700 A	1/1988	Taylor, Jr.	D494,437 S *	8/2004	Scarla ..... D8/99
4,805,303 A	2/1989	Gibbs	D495,939 S	9/2004	Ping
4,811,486 A	3/1989	Cunningham	D501,782 S *	2/2005	Ping ..... D8/99
4,920,644 A	5/1990	LaGattuta	2002/0059730 A1	5/2002	Flavigny
4,936,014 A	6/1990	Shaanan et al.	2004/0020057 A1	2/2004	Hughes
5,044,079 A	9/1991	Gibbs	2004/0045171 A1	3/2004	Moizis
5,095,624 A	3/1992	Ennis	2004/0103541 A1	6/2004	Scarla
5,125,157 A	6/1992	Howard			
5,400,509 A	3/1995	Collins			

\* cited by examiner

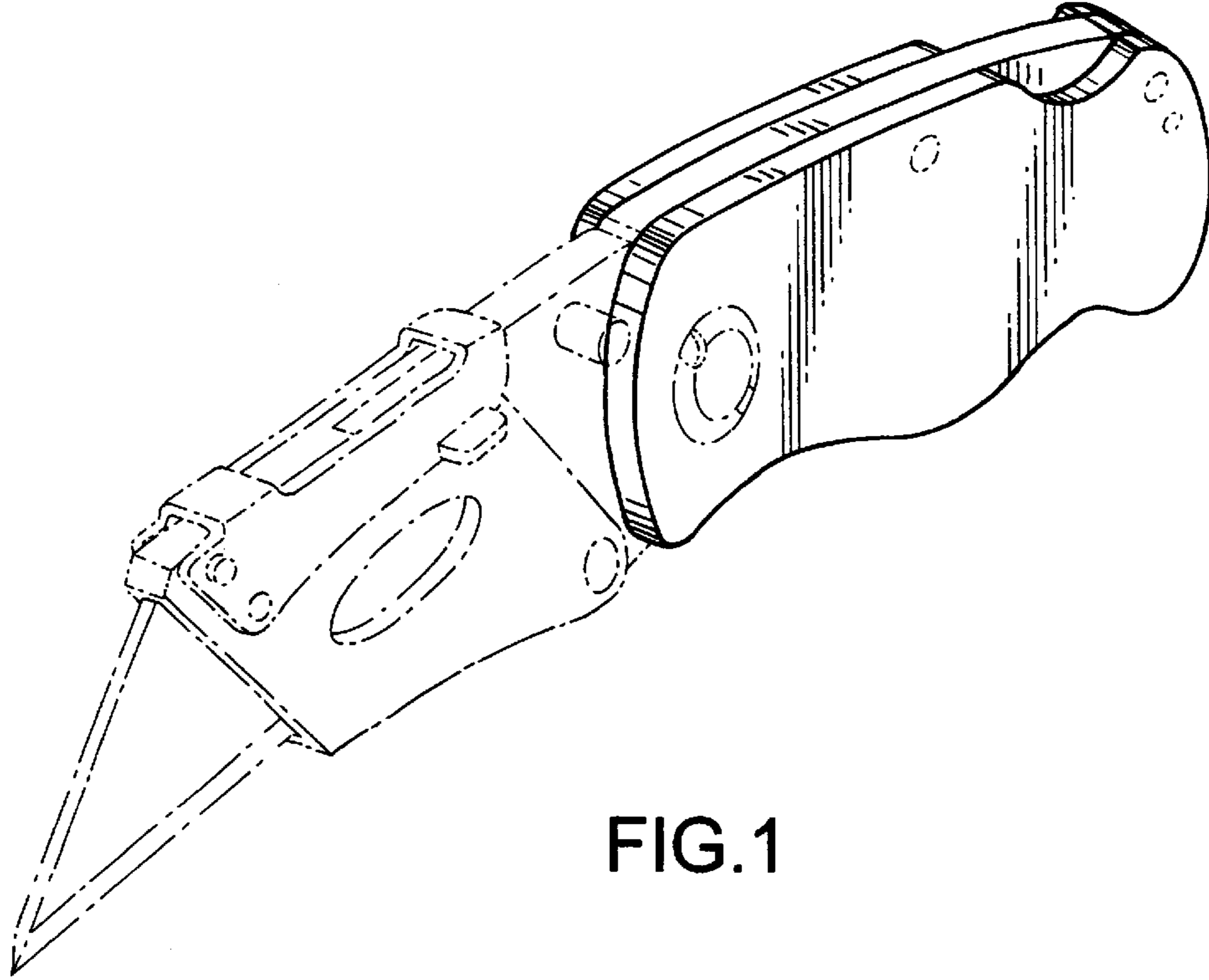

FIG.1

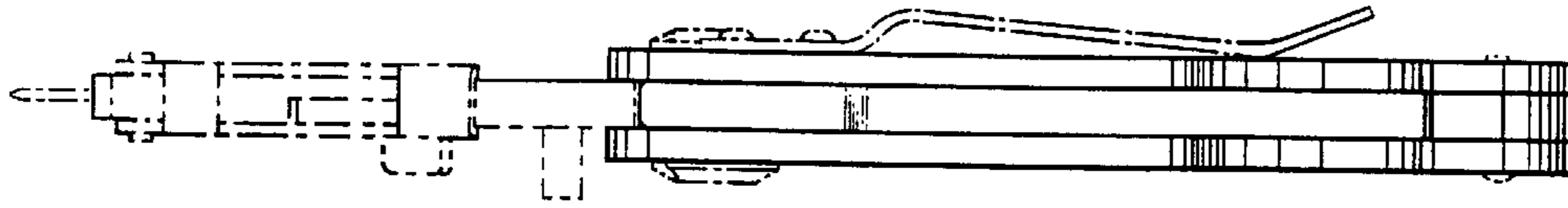

FIG. 2

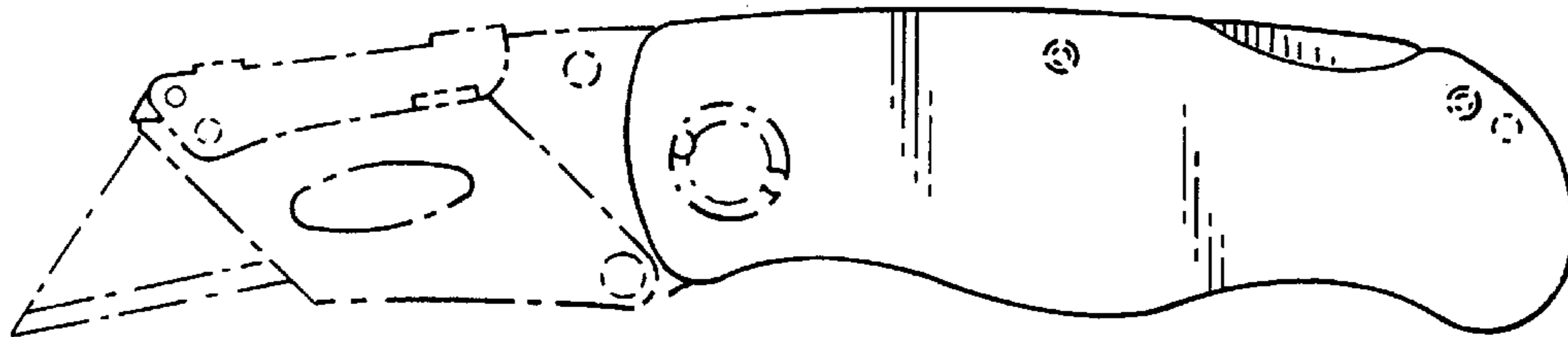

FIG. 3

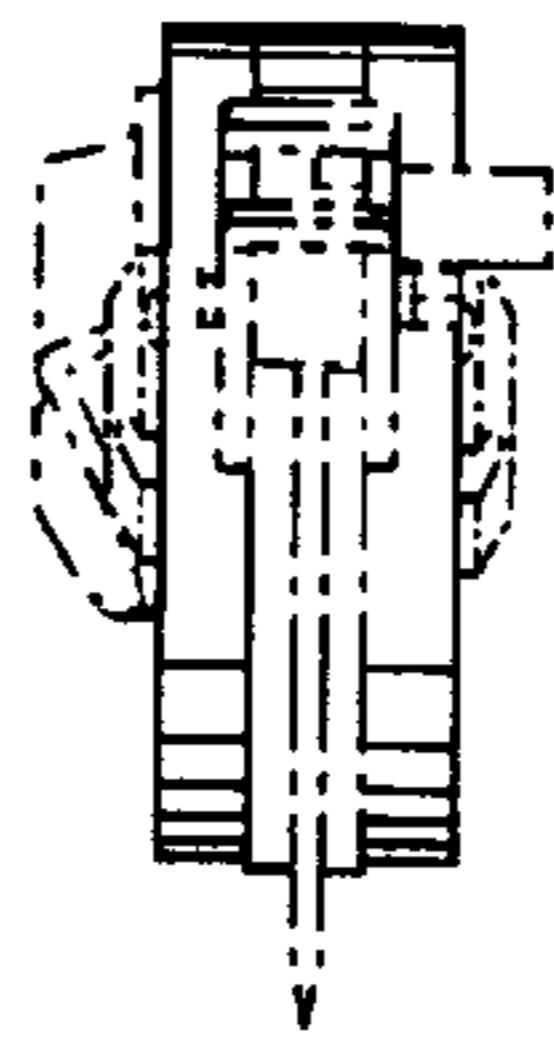

FIG. 4

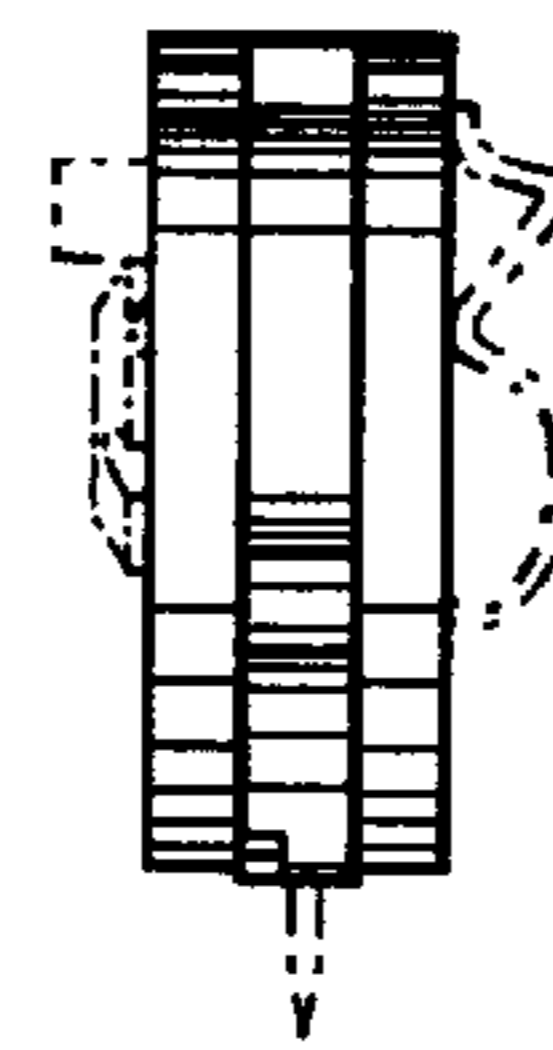

FIG. 5

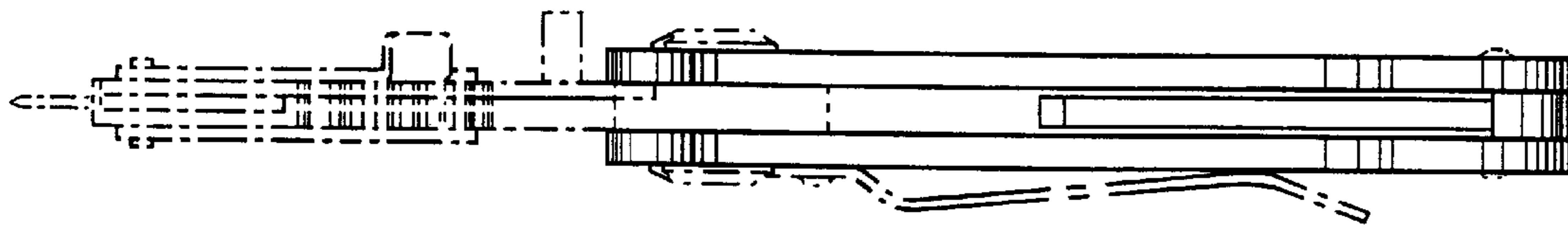

FIG. 6

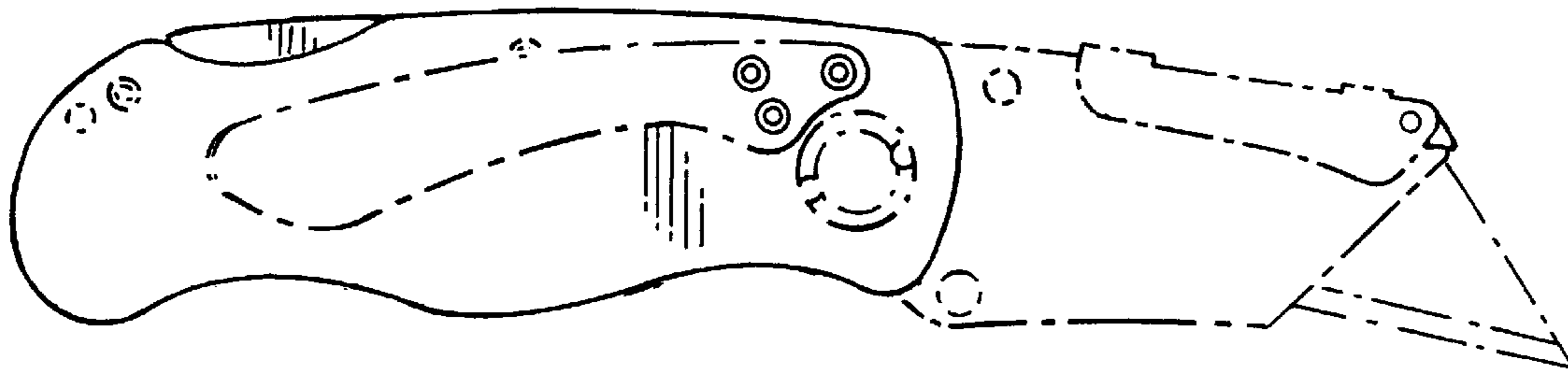
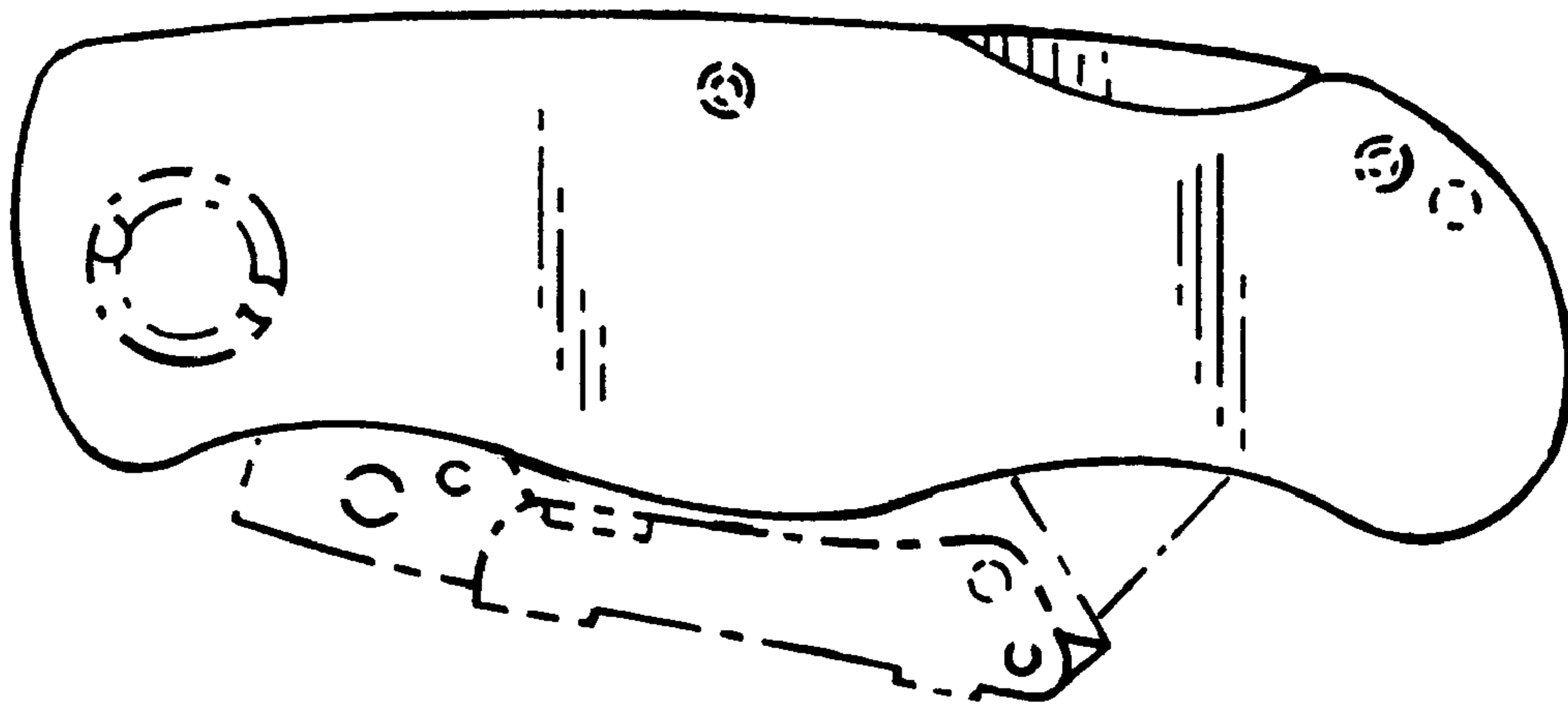
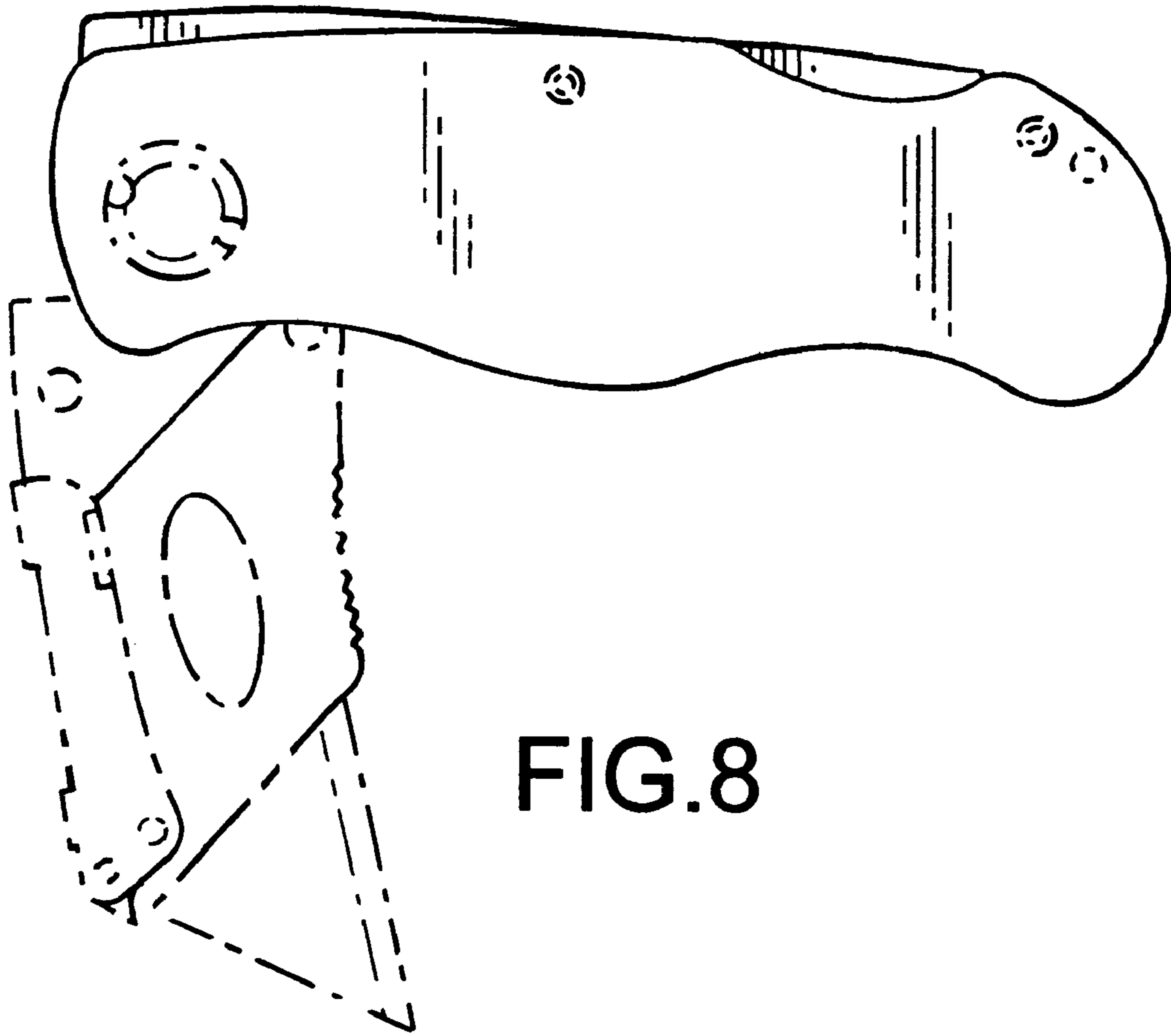

FIG. 7





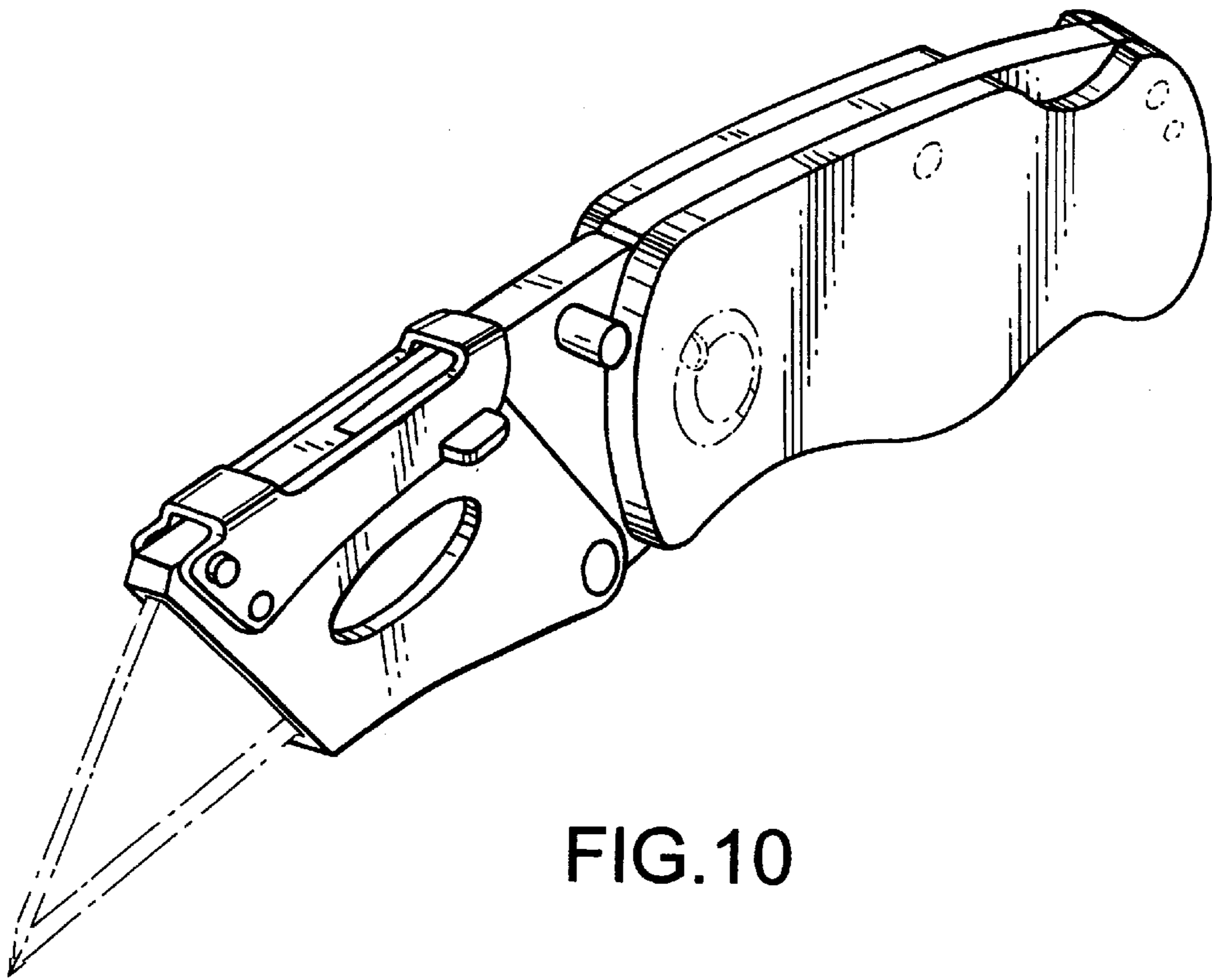

FIG. 10

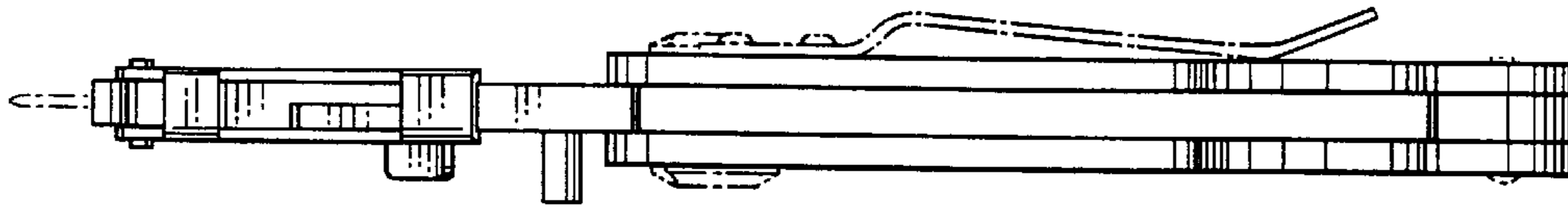

FIG. 11

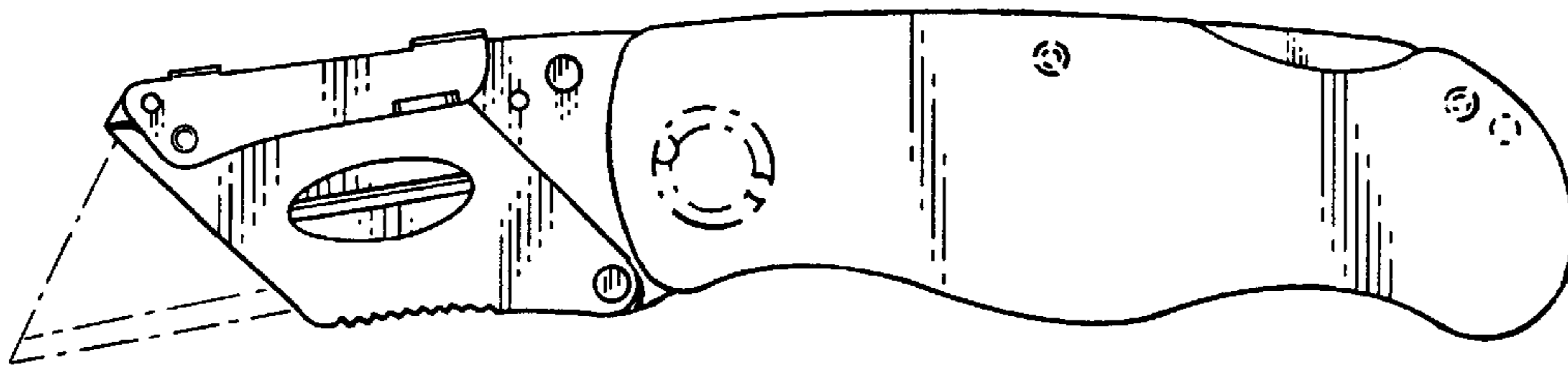

FIG. 12

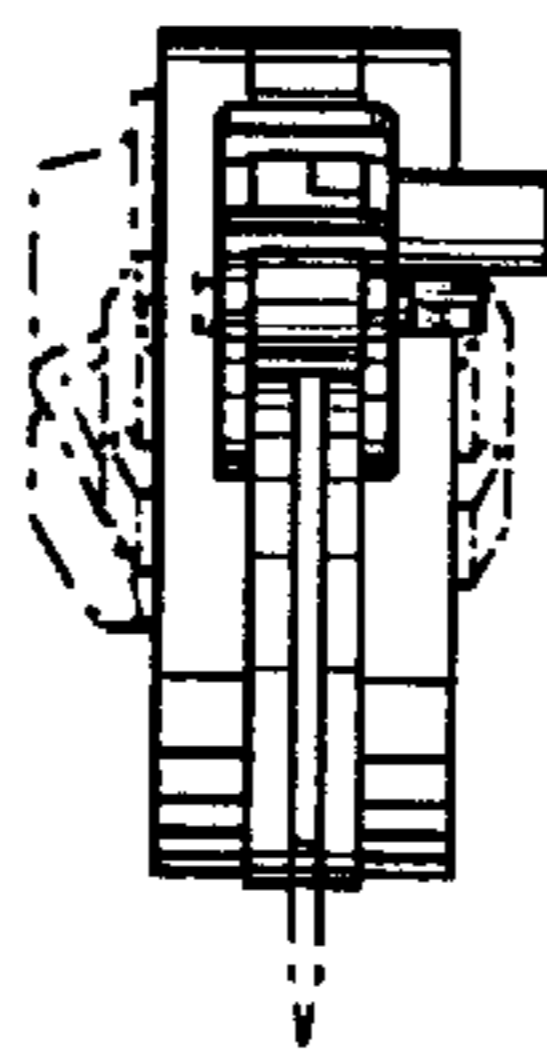

FIG. 13

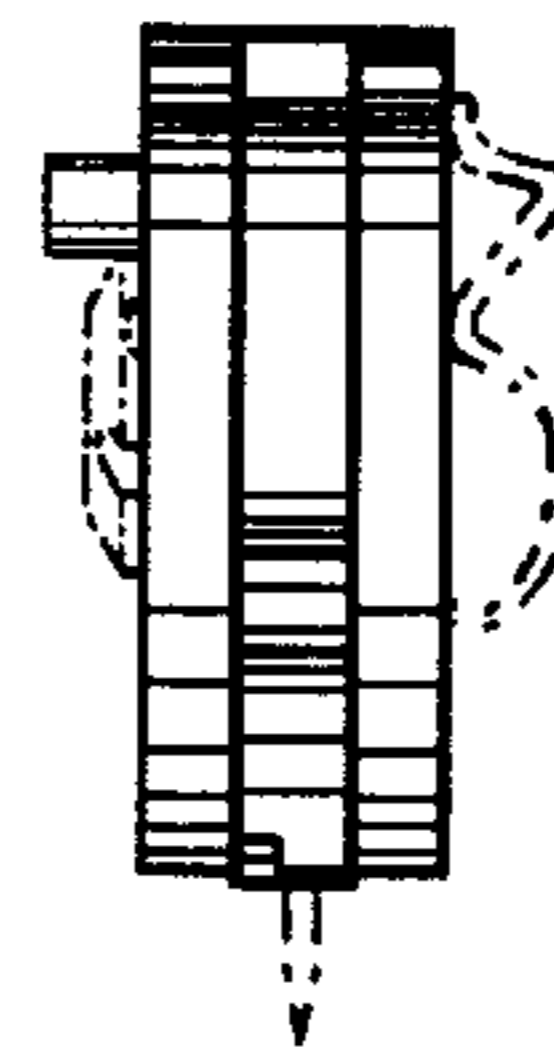

FIG. 14



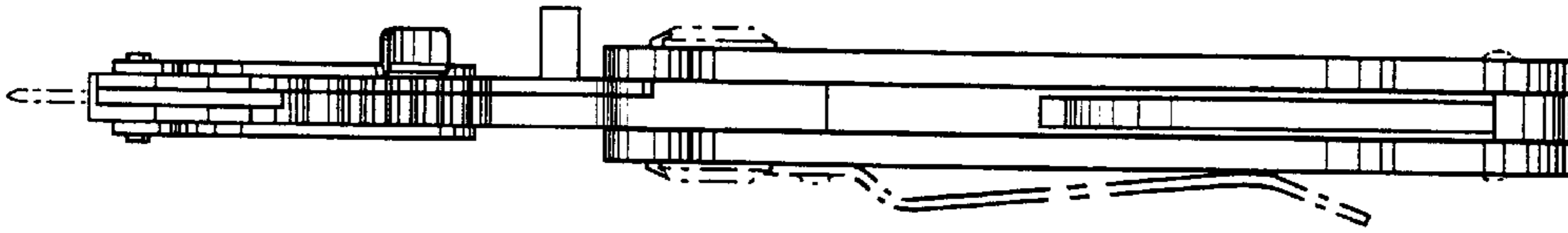

FIG.15

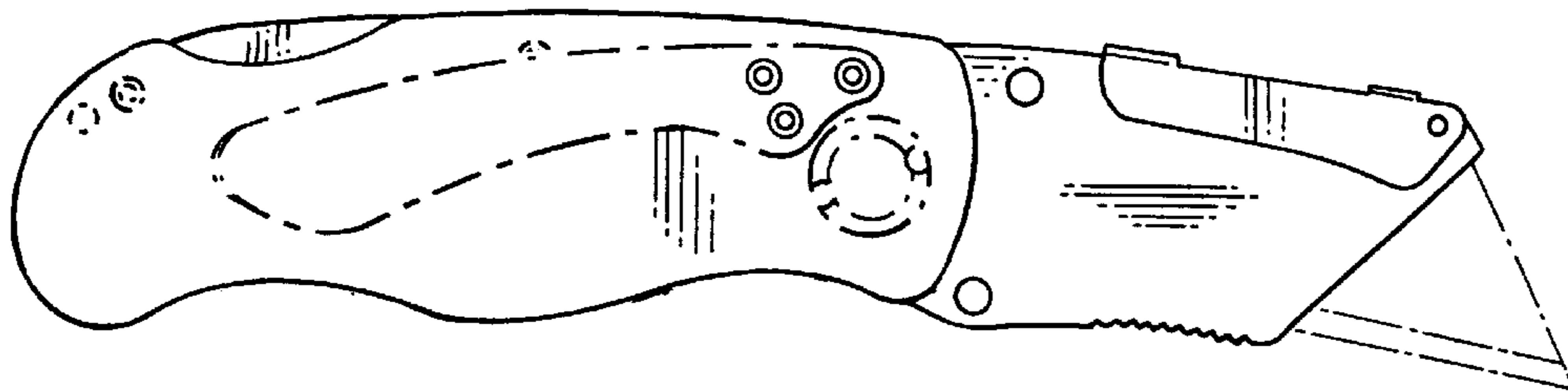

FIG.16

