

US00D528811S

(12) **United States Design Patent**
Giugiaro

(10) **Patent No.:** **US D528,811 S**

(45) **Date of Patent:** **** Sep. 26, 2006**

(54) **CHAIR**

(75) Inventor: **Giorgetto Giugiaro, Moncalieri (IT)**

(73) Assignee: **Okamura Corporation (JP)**

(**) Term: **14 Years**

(21) Appl. No.: **29/226,163**

(22) Filed: **Mar. 24, 2005**

(30) **Foreign Application Priority Data**

Sep. 27, 2004 (JP) 2004-029100

(51) **LOC (8) Cl.** **06-01**

(52) **U.S. Cl.** **D6/366**

(58) **Field of Classification Search** D6/334-336,
D6/364, 365, 366, 367, 369, 379, 380, 500-502;
297/411.2, 411.27, 411.36
See application file for complete search history.

(56) **References Cited**

U.S. PATENT DOCUMENTS

D436,259 S	*	1/2001	Nagamitsu	D6/366
D449,174 S	*	10/2001	Neil	D6/366
D451,293 S	*	12/2001	Su	D6/366
D453,079 S	*	1/2002	Ma	D6/366

D471,024 S	*	3/2003	Chadwick et al.	D6/366
D474,346 S	*	5/2003	Saylor et al.	D6/366
D476,493 S	*	7/2003	Nagamitsu	D6/366
D476,821 S	*	7/2003	Koepke et al.	D6/366
D477,151 S	*	7/2003	Koepke et al.	D6/366
D479,656 S	*	9/2003	Ma	D6/366
D487,359 S	*	3/2004	Giugiaro	D6/366
D489,191 S	*	5/2004	Ma	D6/366
D489,542 S	*	5/2004	Giugiaro	D6/366
D493,627 S	*	8/2004	Ma	D6/366
D494,768 S	*	8/2004	Su	D6/366
D495,509 S	*	9/2004	Breen	D6/366

* cited by examiner

Primary Examiner—Mimosa De

(57) **CLAIM**

I claim the ornamental design for a chair, as shown.

DESCRIPTION

FIG. 1 is a front elevational view of a chair showing my new design;
FIG. 2 is a right side view thereof;
FIG. 3 is a top plan view thereof;
FIG. 4 is a rear elevational view thereof;
FIG. 5 is a left side view thereof; and,
FIG. 6 is a bottom plan view thereof.

1 Claim, 3 Drawing Sheets

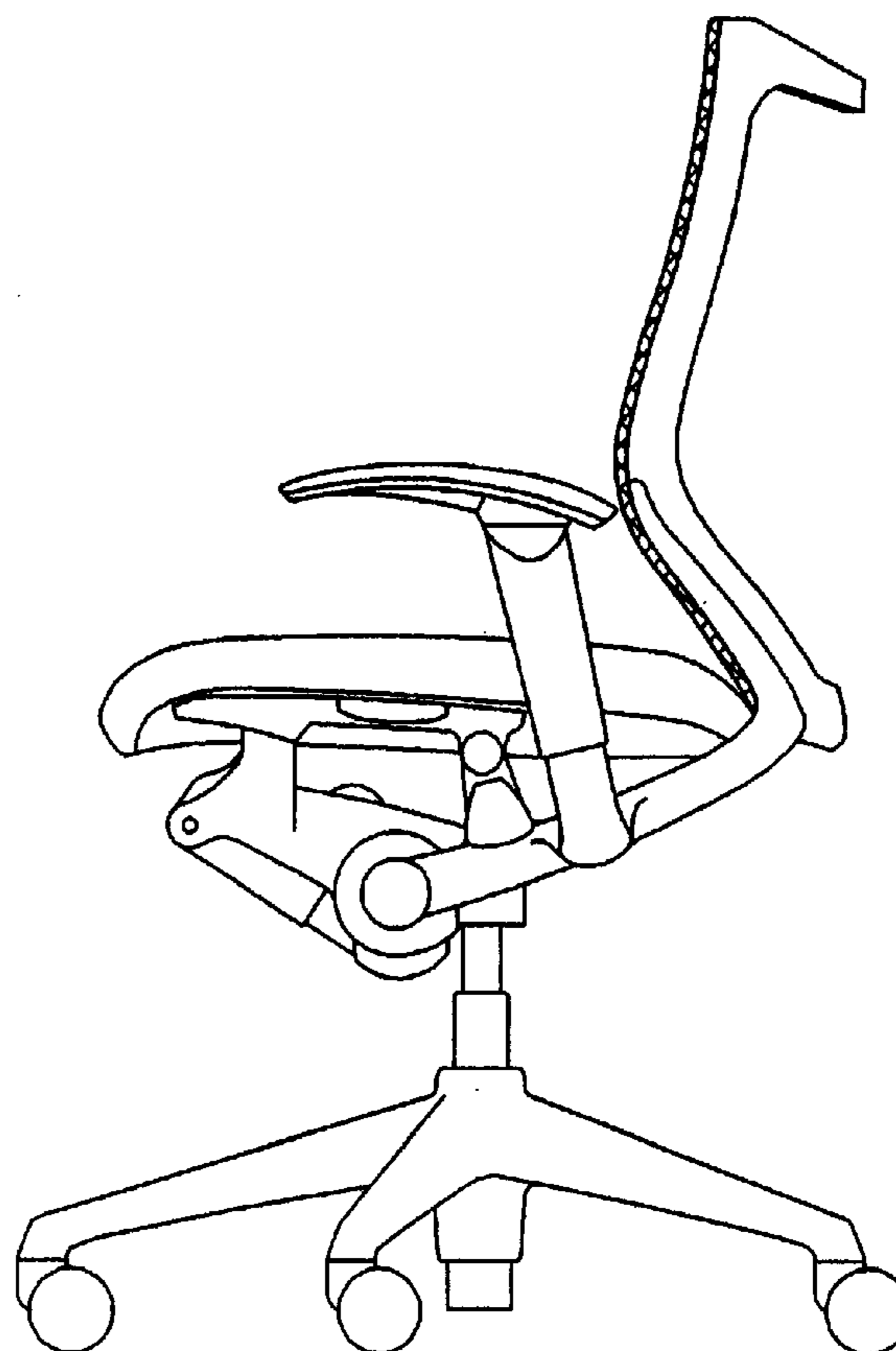
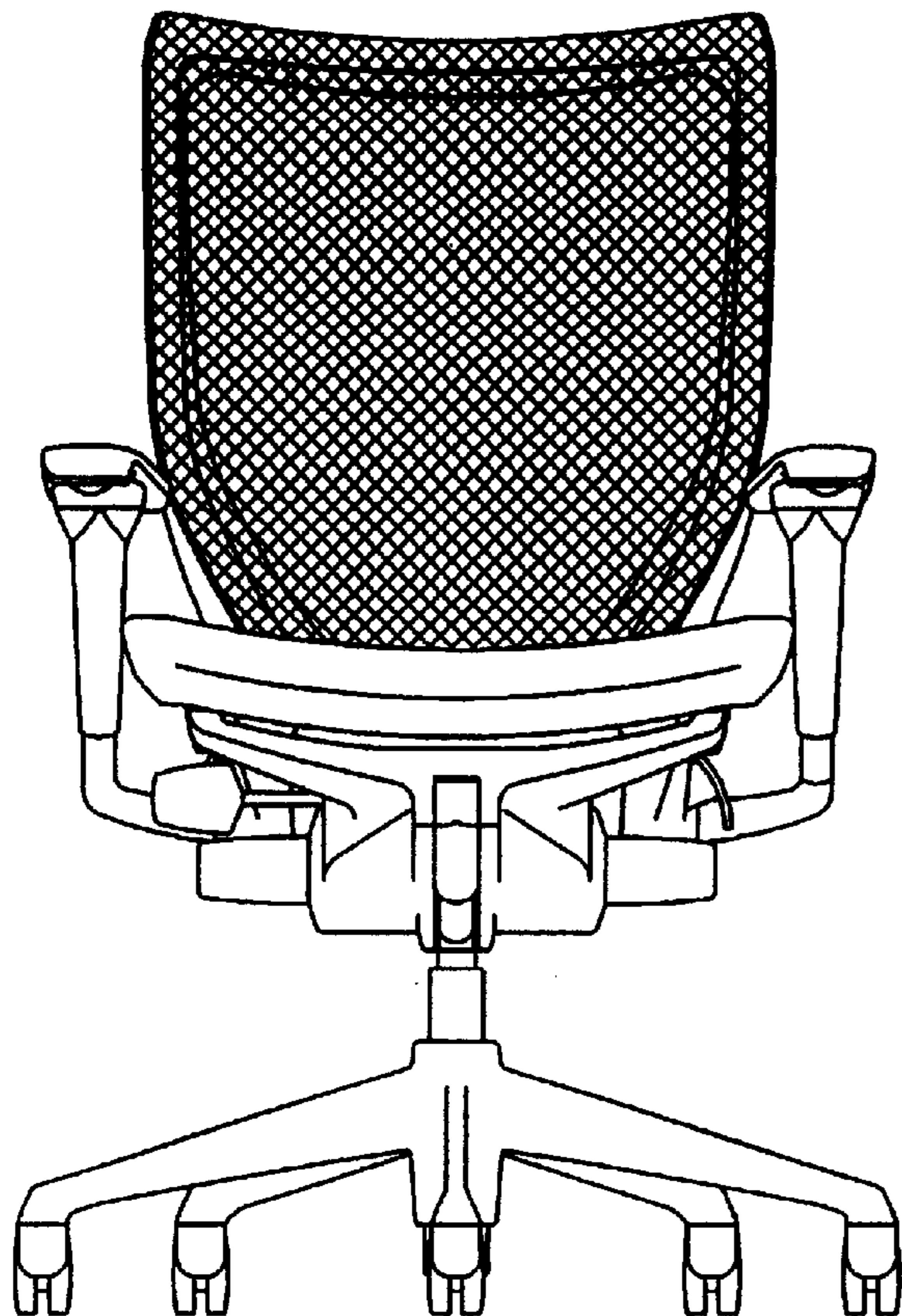

Fig.1

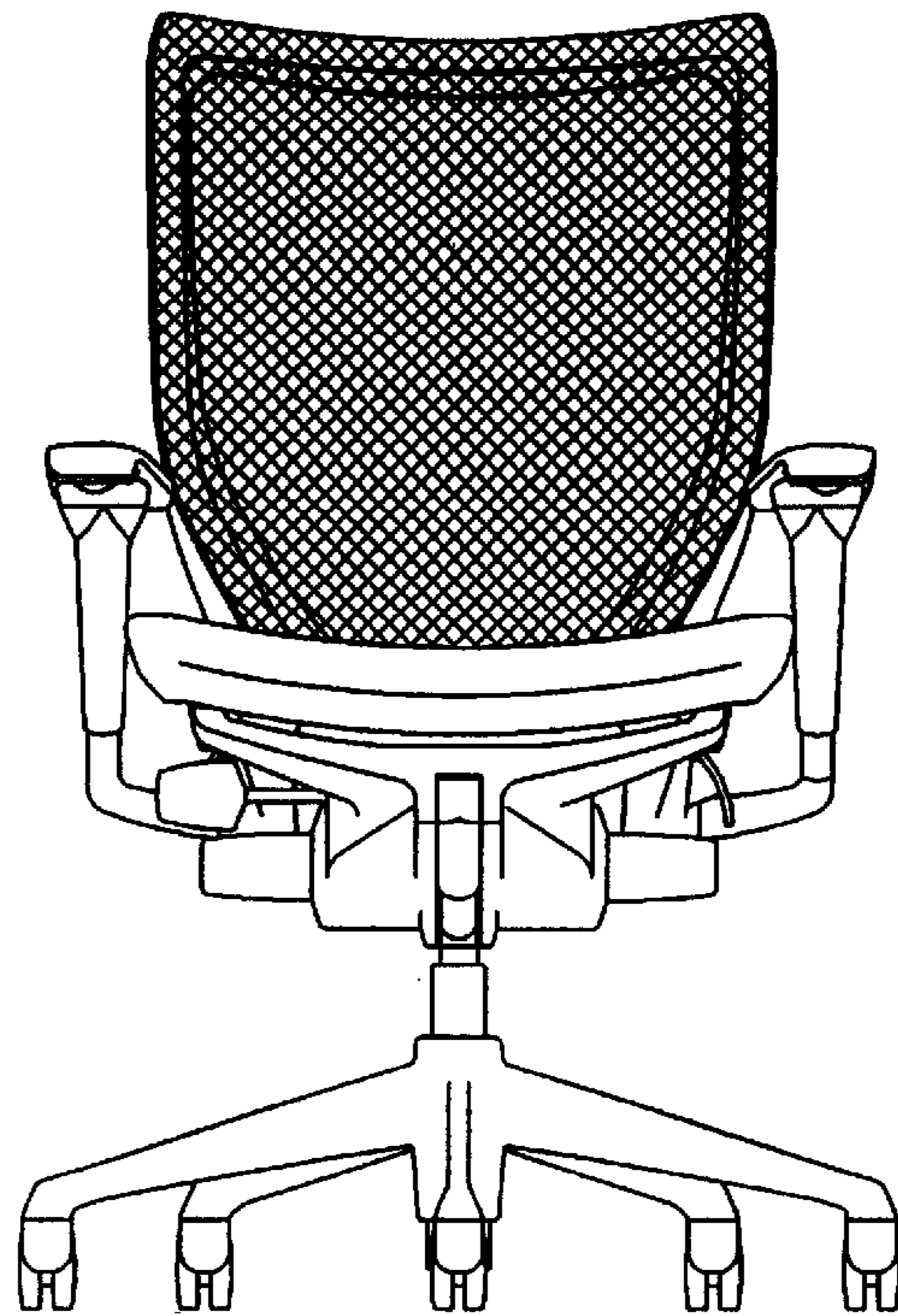

Fig.2

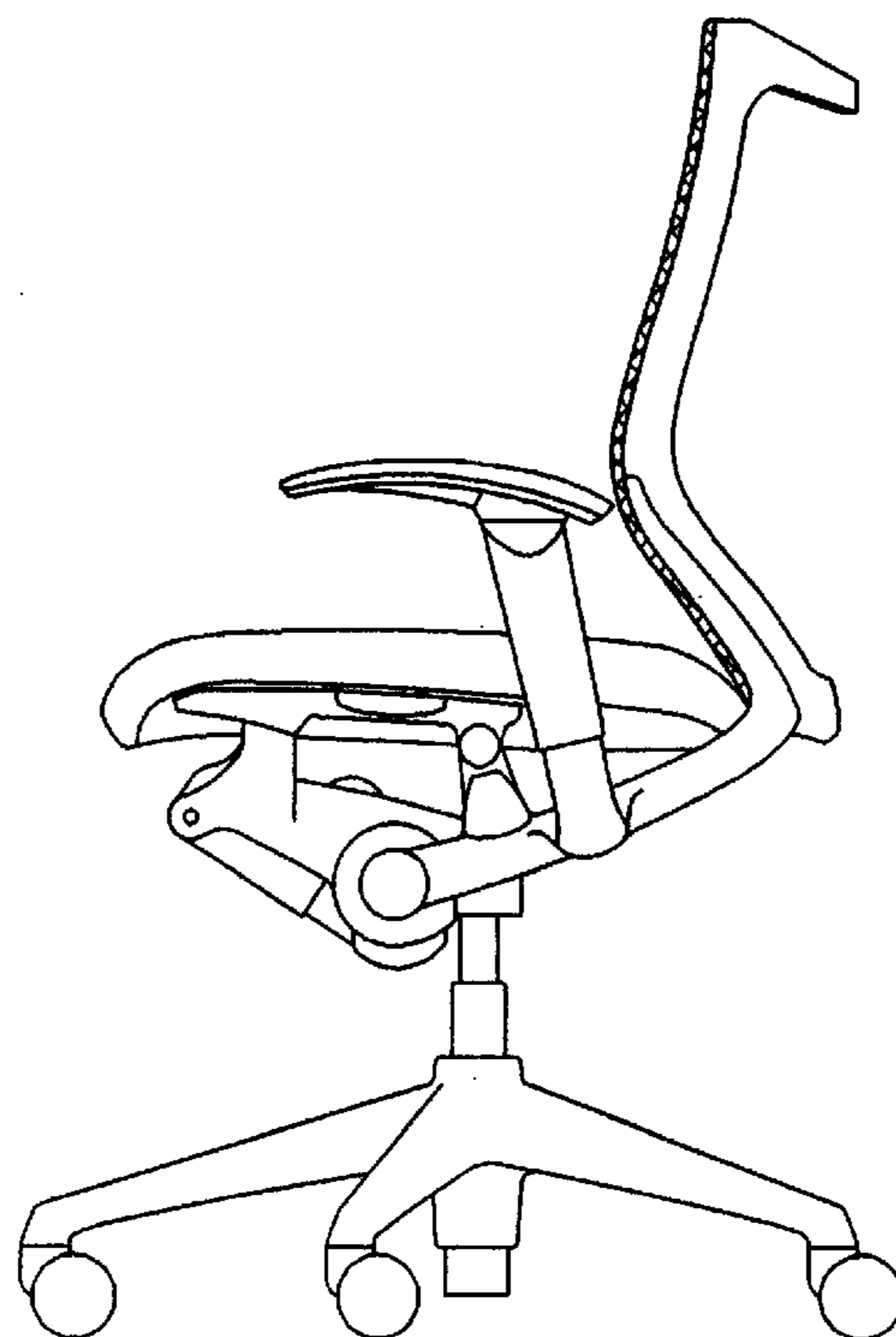

Fig.3

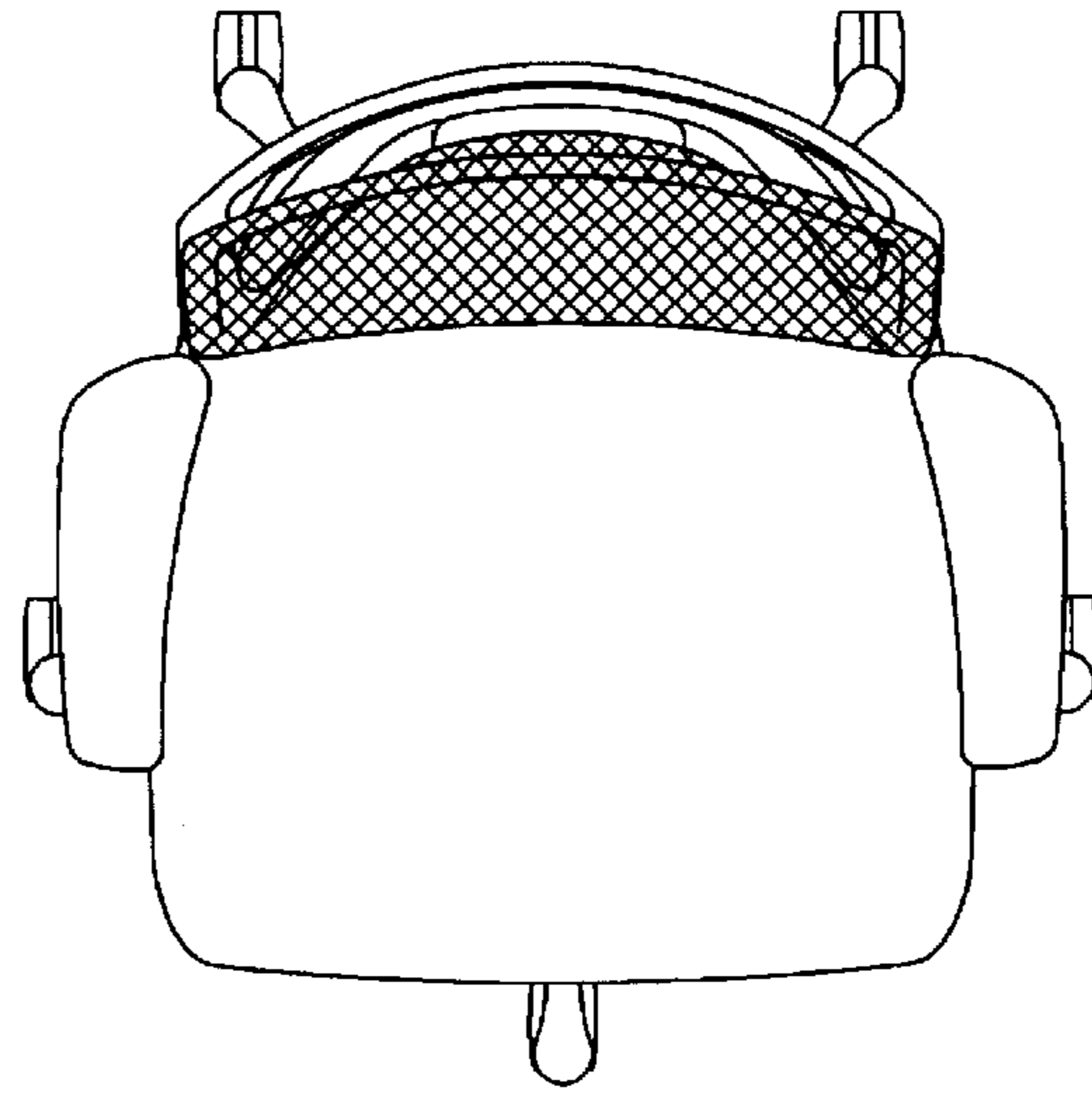

Fig.4

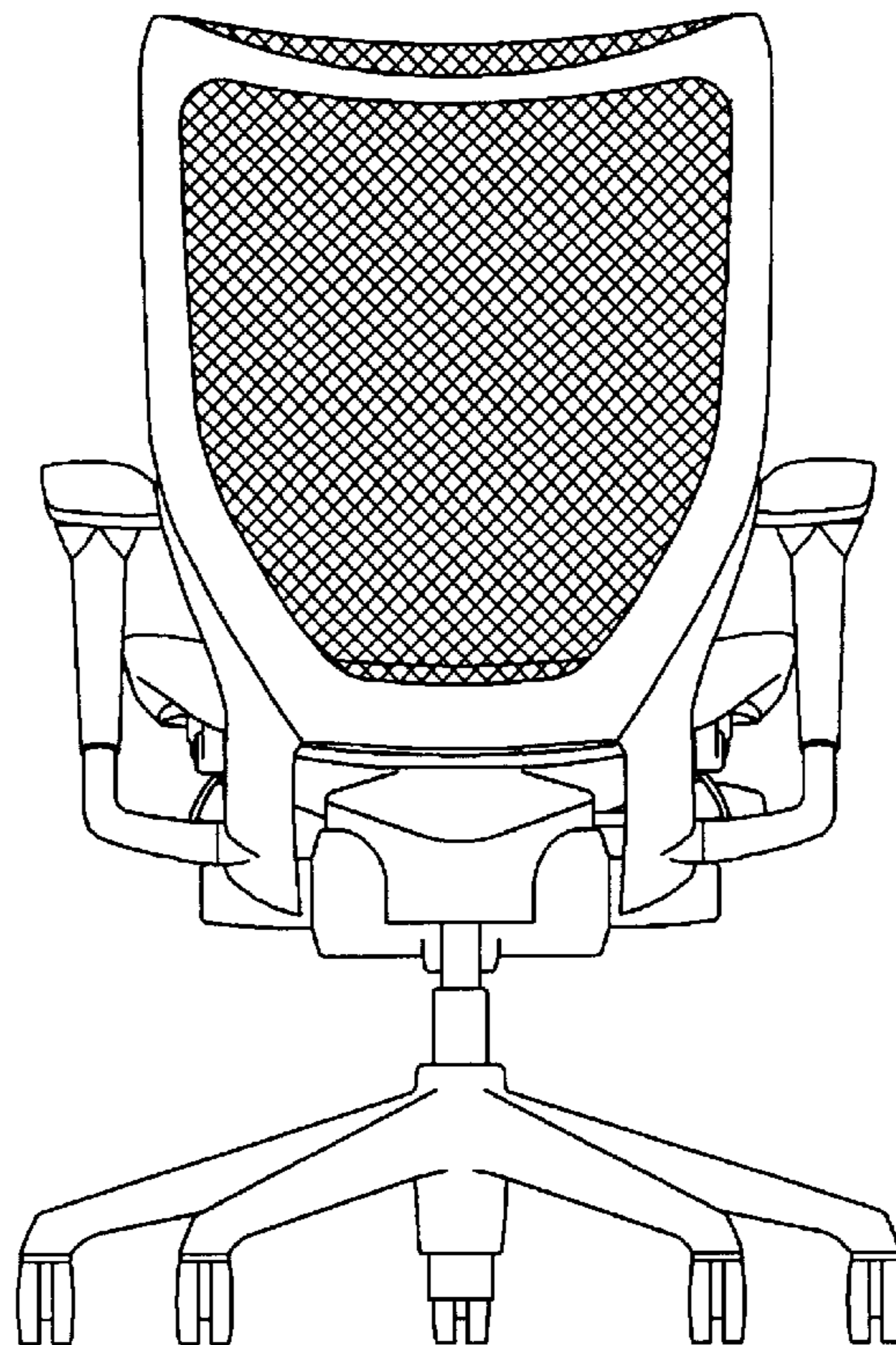

Fig.5

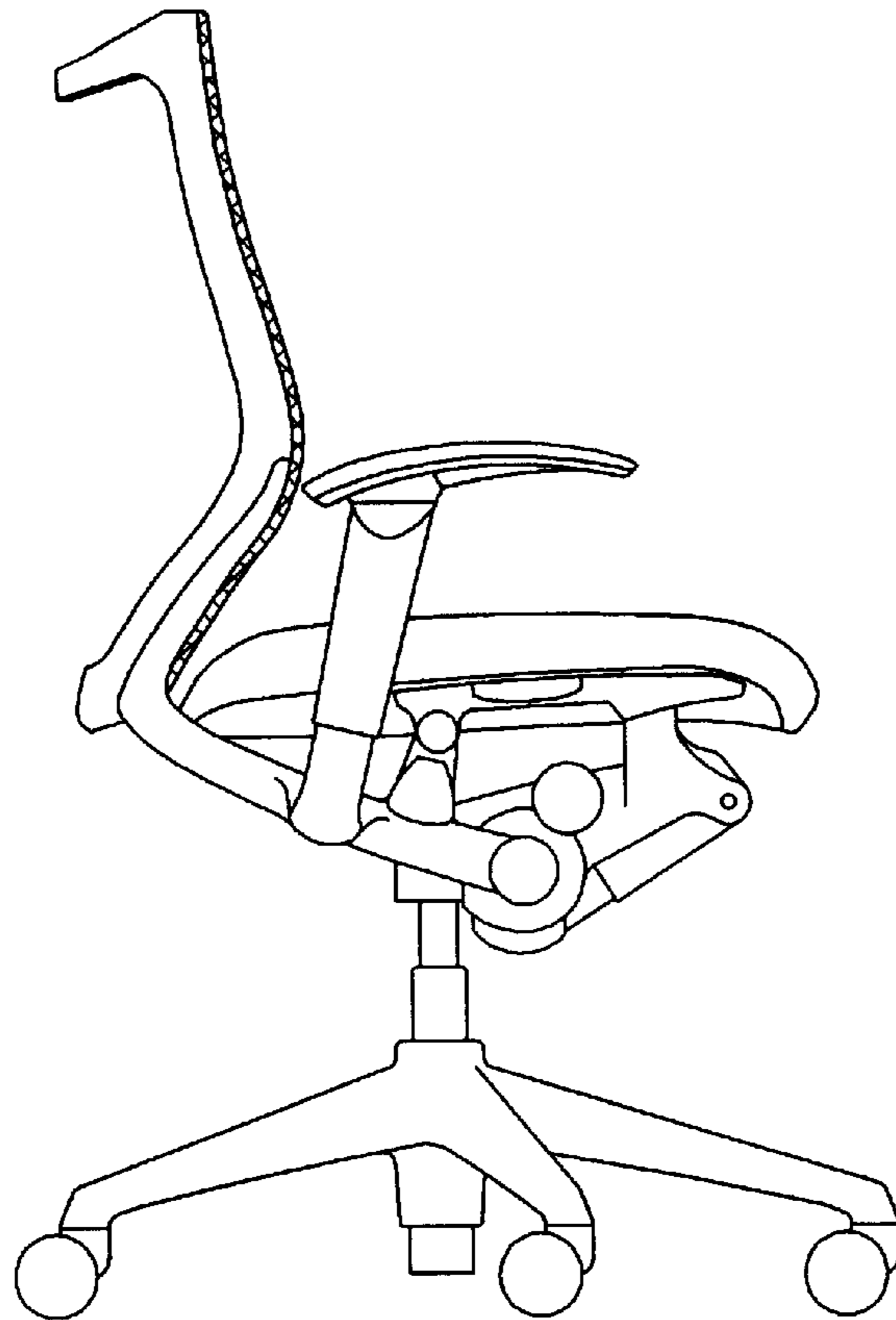

Fig.6

