



US00D528672S

(12) **United States Design Patent**  
**Nagai et al.**

(10) **Patent No.:** **US D528,672 S**  
(45) **Date of Patent:** **\*\* Sep. 19, 2006**

(54) **LED MODULE**

FOREIGN PATENT DOCUMENTS

(75) Inventors: **Hideo Nagai**, Takatsuki (JP); **Noriyasu Tanimoto**, Takatsuki (JP); **Keiji Nishimoto**, Takatsuki (JP); **Takeshi Saito**, Nishinomiya (JP)

JP D1183708 9/2003

\* cited by examiner

*Primary Examiner*—Marcus A. Jackson  
(74) *Attorney, Agent, or Firm*—Brinks Hofer Gilson & Lione

(73) Assignee: **Matsushita Electric Industrial Co., Ltd.**, Osaka (JP)

(\*\*) Term: **14 Years**

(57) **CLAIM**

We claim the ornamental design for an LED module, as shown and described.

(21) Appl. No.: **29/235,064**

(22) Filed: **Jul. 27, 2005**

**DESCRIPTION**

(30) **Foreign Application Priority Data**

Jan. 28, 2005 (JP) ..... 2005-002252  
Jan. 28, 2005 (JP) ..... 2005-002253

FIG. 1 is a top perspective view of a first embodiment of an LED module of the present invention;  
FIG. 2 is a top view thereof, wherein the bottom view is a mirror image thereof;  
FIG. 3 is a left side view thereof, wherein the right side view is a mirror image thereof;  
FIG. 4 is a front view thereof;  
FIG. 5 is a rear view thereof;  
FIG. 6 is a top perspective view of a second embodiment of an LED module of the present invention;  
FIG. 7 is a top view thereof, wherein the bottom view is a mirror image thereof;  
FIG. 8 is a left side view thereof, wherein the right side view is a mirror image thereof;  
FIG. 9 is a front view thereof; and,  
FIG. 10 is a rear view thereof.

(51) **LOC (8) Cl.** ..... **26-04**  
(52) **U.S. Cl.** ..... **D26/1**  
(58) **Field of Classification Search** ..... D26/1-4;  
340/521, 540, 541, 545, 555, 571, 572, 573,  
340/628-630

See application file for complete search history.

(56) **References Cited**

U.S. PATENT DOCUMENTS

D437,798 S \* 2/2001 Kiba et al. .... D10/104  
D455,365 S \* 4/2002 Madanat ..... D10/115  
D464,744 S \* 10/2002 Kato et al. .... D26/1  
D508,574 S \* 8/2005 Janssen ..... D26/1  
D513,599 S \* 1/2006 Coward ..... D10/120

**1 Claim, 2 Drawing Sheets**

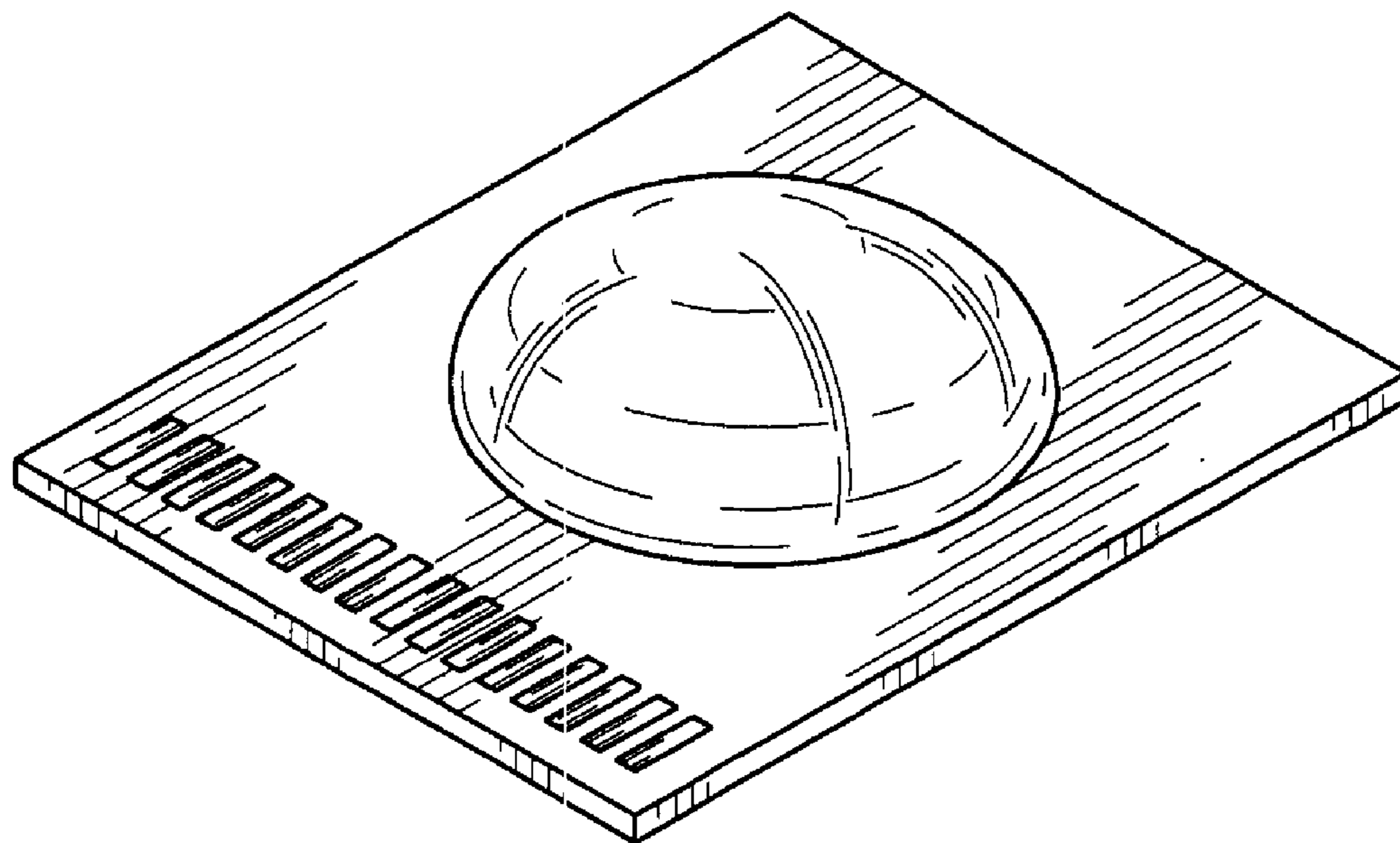

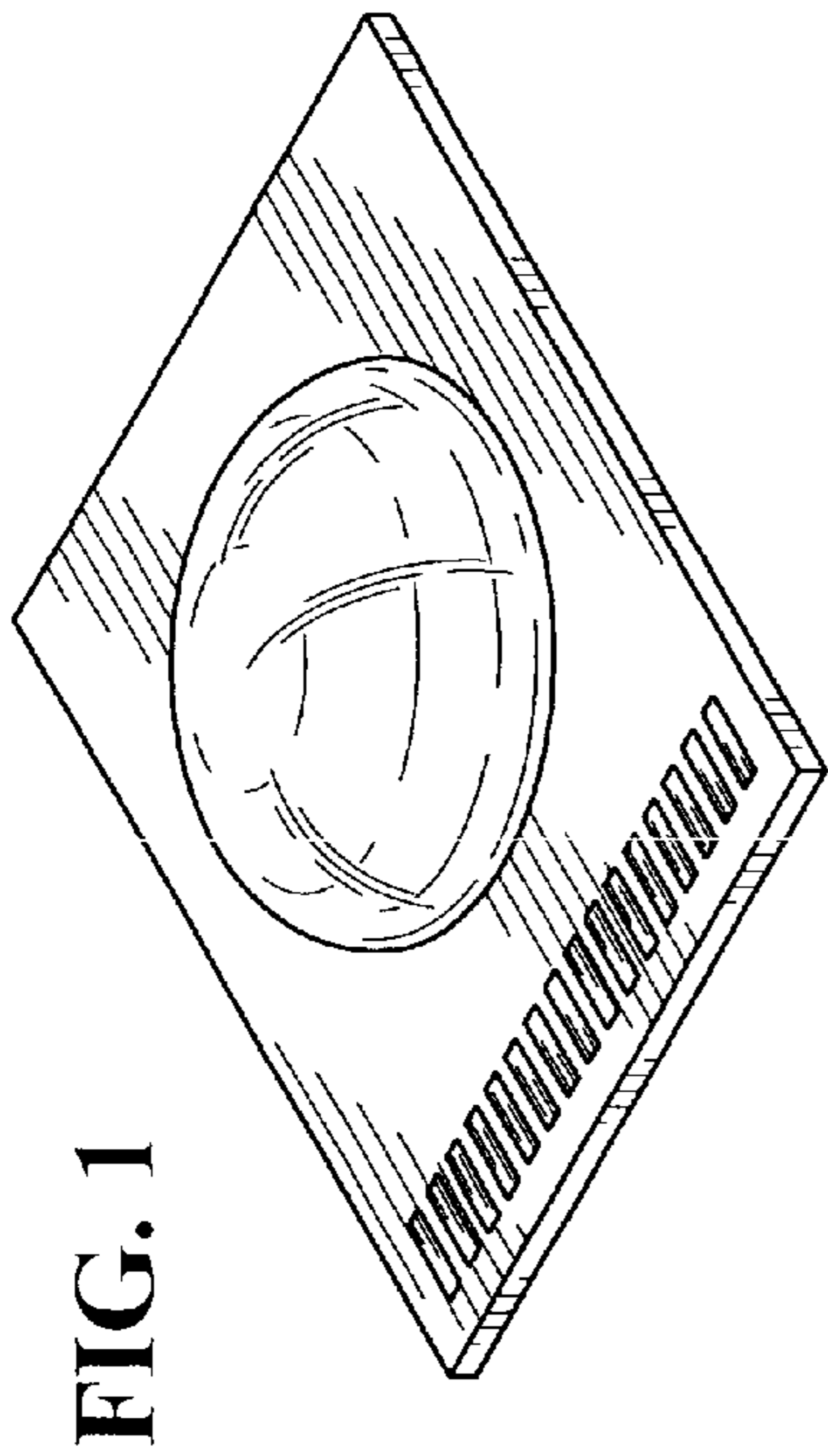

FIG. 1

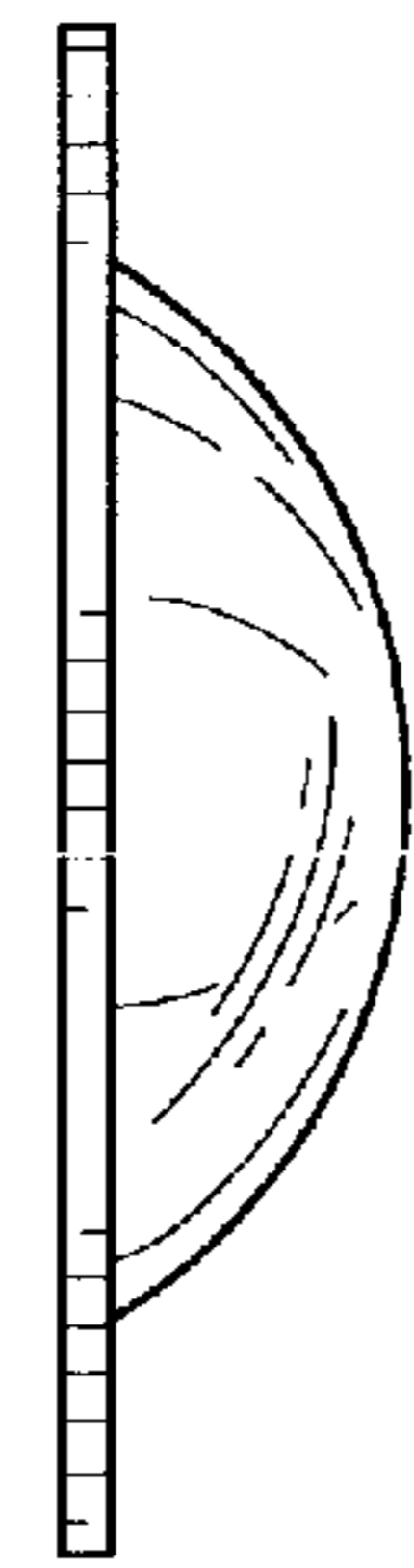

FIG. 2

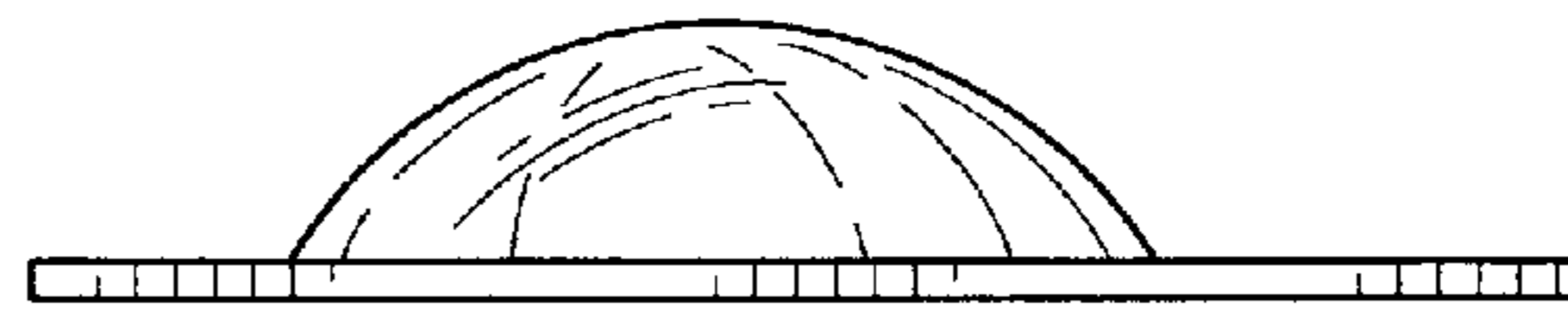

FIG. 3

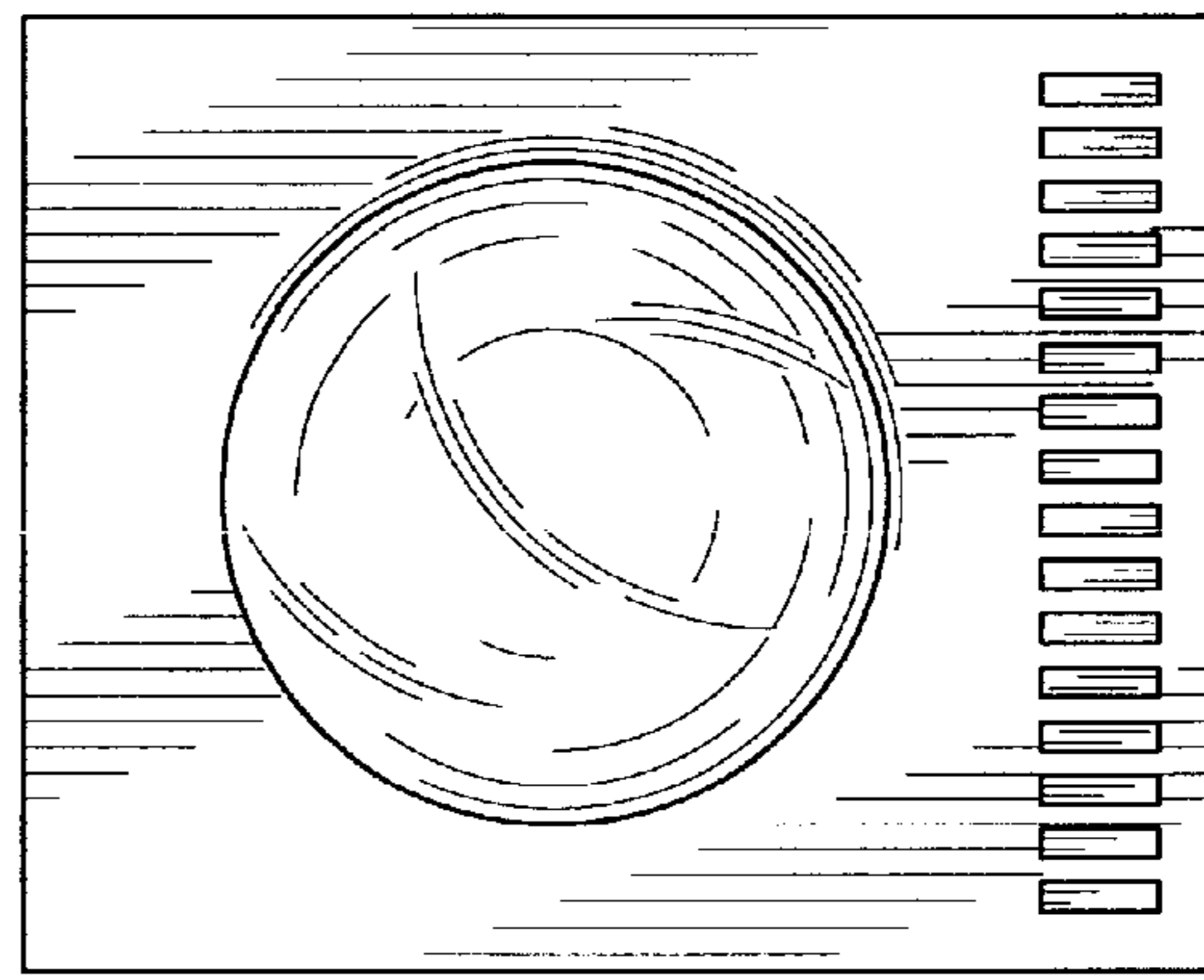

FIG. 4

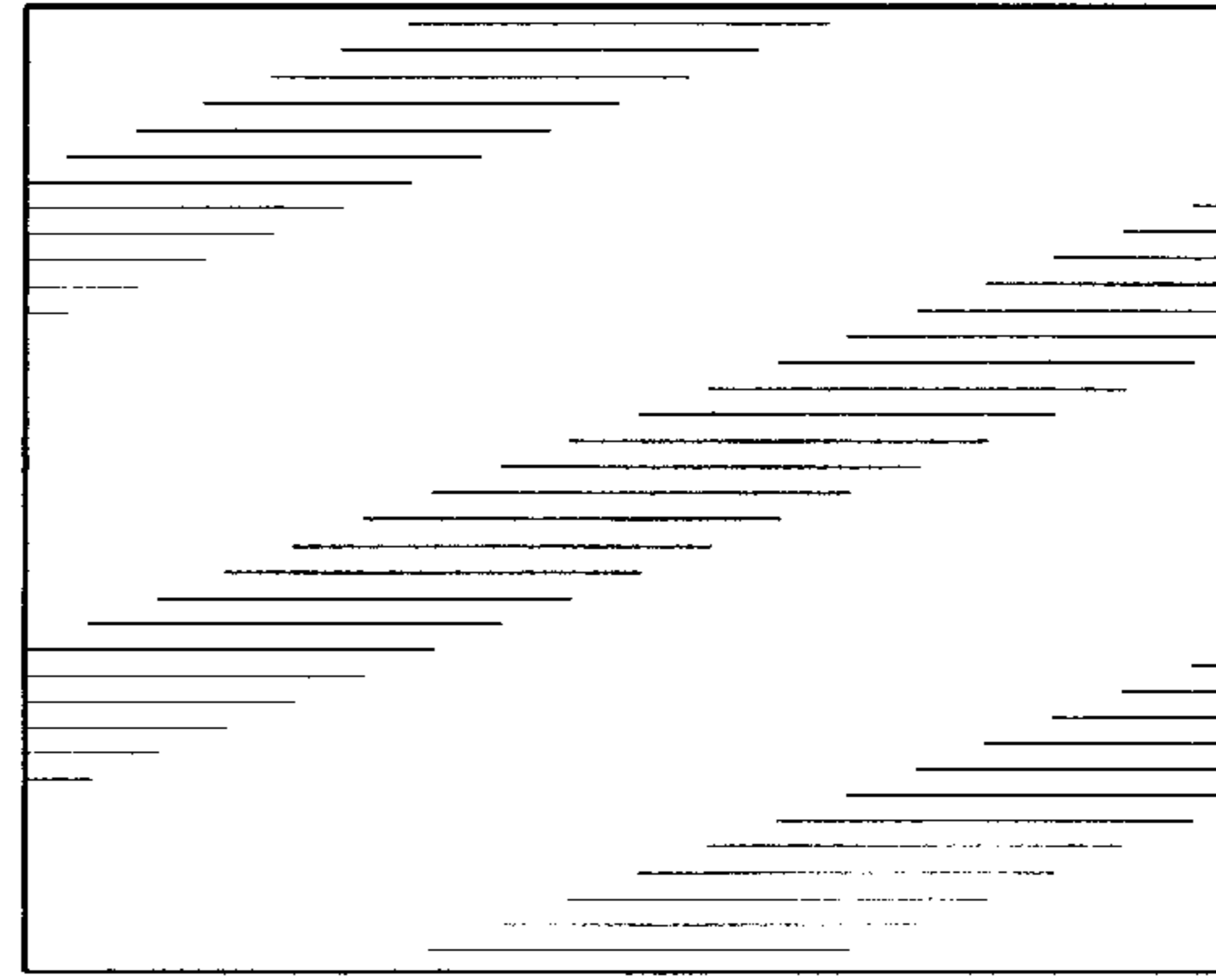

FIG. 5

FIG. 6

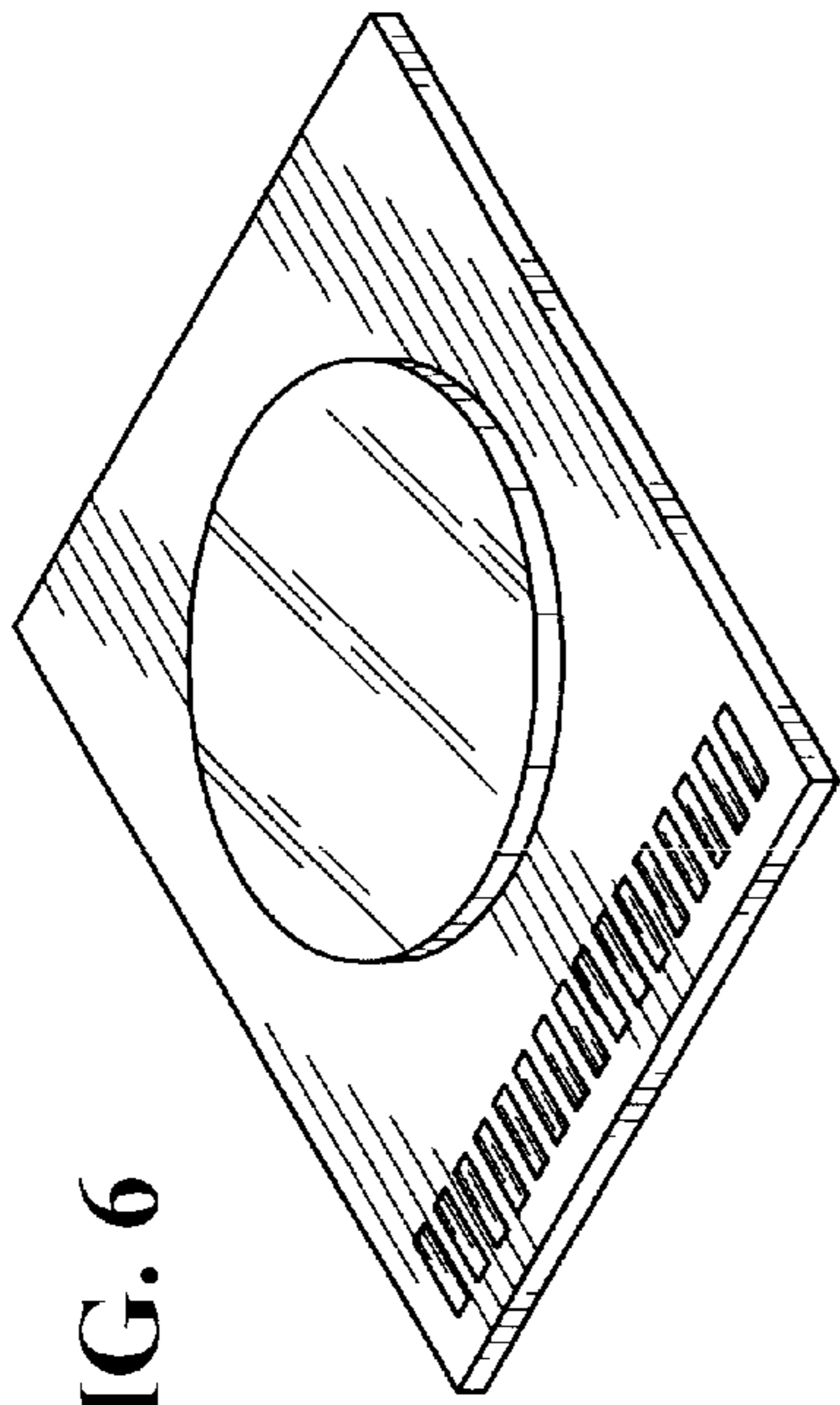

FIG. 7

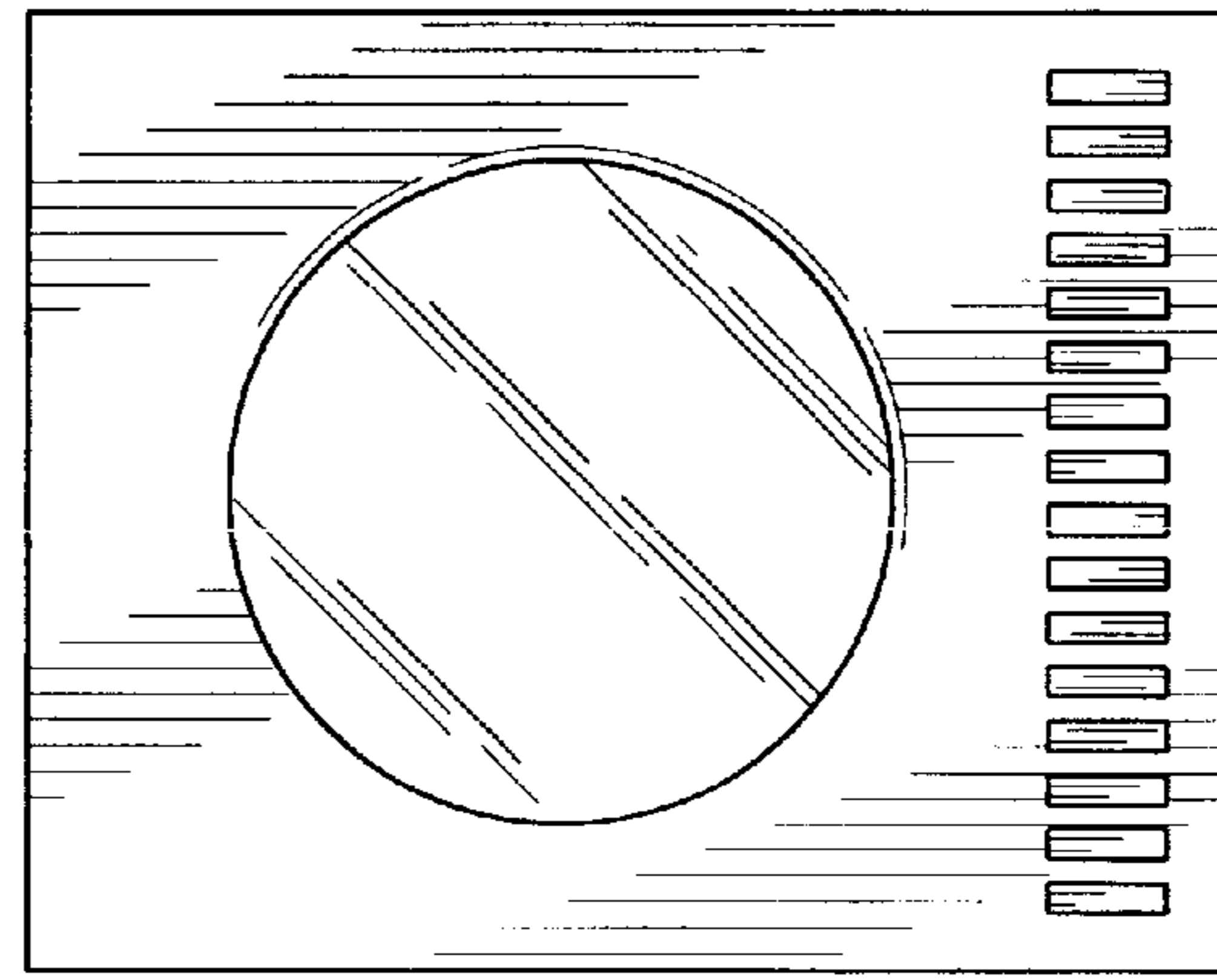
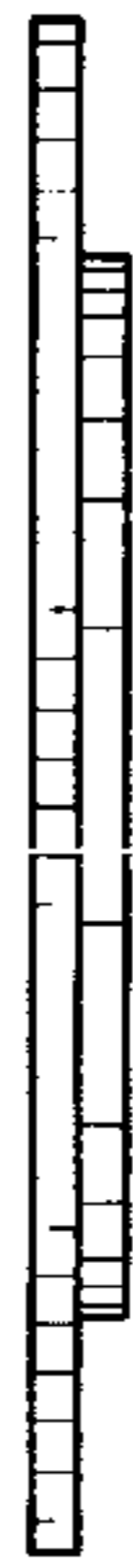

FIG. 9

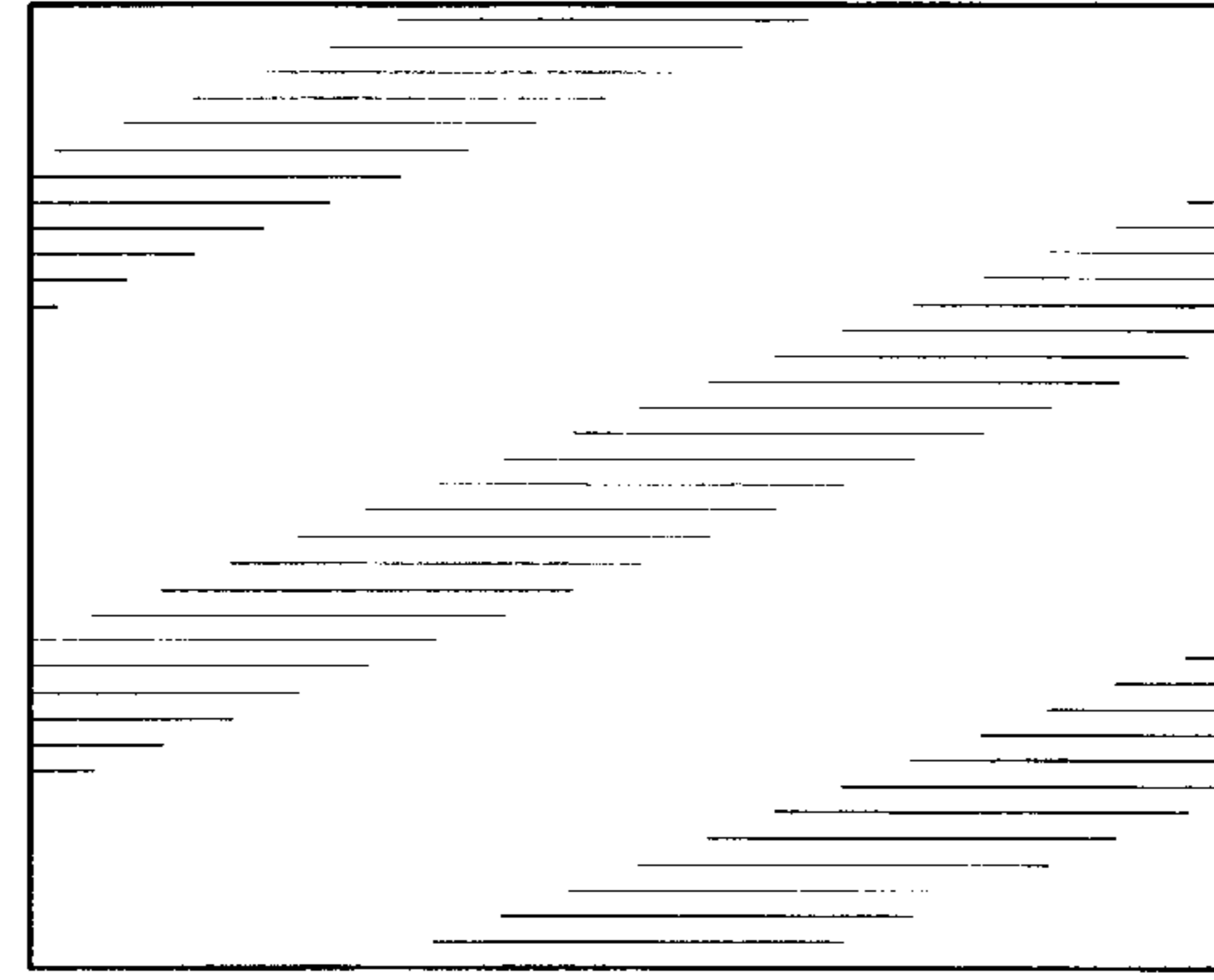

FIG. 10

FIG. 8

